

# SERVICE MANUAL

# BA-5D CHASSIS

<u>MODEL NAME</u>	<u>REMOTE COMMANDER</u>	<u>DESTINATION</u>	<u>CHASSIS NO.</u>
<b>KV-27FS100</b>	RM-Y180	US	SCC-S65D-A
<b>KV-27FS100</b>	RM-Y180	CND	SCC-S64D-A
<b>KV-27FS200</b>	RM-Y181	US	SCC-S65E-A
<b>KV-29FS100</b>	RM-Y180	LATIN NORTH	SCC-S62H-A
<b>KV-29FS100</b>	RM-Y180	LATIN SOUTH	SCC-S62J-A
<b>KV-32FS100</b>	RM-Y180	US	SCC-S65F-A
<b>KV-32FS100</b>	RM-Y180	CND	SCC-S64E-A
<b>KV-32FS200</b>	RM-Y181	US	SCC-S65G-A
<b>KV-34FS100</b>	RM-Y180	LATIN NORTH	SCC-S62K-A
<b>KV-34FS100</b>	RM-Y180	LATIN SOUTH	SCC-S62L-A

**ORIGINAL MANUAL ISSUE DATE: 6/2002**

ALL REVISIONS AND UPDATES TO THE ORIGINAL MANUAL ARE APPENDED TO THE END OF THE PDF FILE.

<u>REVISION DATE</u>	<u>REVISION TYPE</u>	<u>SUBJECT</u>
6/2002	No revisions or updates are applicable at this time.	
4/2003	Correction -1	Replaced GK Board IC Voltage List (IC600) (Page 46) Replaced GK Board Transistor Voltage List (Q600, Q601) (Page 46)

TRINITRON® COLOR TELEVISION  
**SONY®**

# SERVICE MANUAL

# BA-5D CHASSIS

<u>MODEL NAME</u>	<u>REMOTE COMMANDER</u>	<u>DESTINATION</u>	<u>CHASSIS NO.</u>
<b>KV-27FS100</b>	RM-Y180	US	SCC-S65D-A
<b>KV-27FS100</b>	RM-Y180	CND	SCC-S64D-A
<b>KV-27FS200</b>	RM-Y181	US	SCC-S65E-A
<b>KV-29FS100</b>	RM-Y180	LATIN NORTH	SCC-S62H-A
<b>KV-29FS100</b>	RM-Y180	LATIN SOUTH	SCC-S62J-A
<b>KV-32FS100</b>	RM-Y180	US	SCC-S65F-A
<b>KV-32FS100</b>	RM-Y180	CND	SCC-S64E-A
<b>KV-32FS200</b>	RM-Y181	US	SCC-S65G-A
<b>KV-34FS100</b>	RM-Y180	LATIN NORTH	SCC-S62K-A
<b>KV-34FS100</b>	RM-Y180	LATIN SOUTH	SCC-S62L-A



KV-32FS200



RM-Y181

TRINITRON® COLOR TELEVISION

# SONY®

# TABLE OF CONTENTS

SECTION TITLE	PAGE
Specifications.....	4
Warnings and Cautions.....	5
Safety Check-Out .....	6
Self-Diagnostic Function.....	7
<b>1. Disassembly</b>	
1-1. Rear Cover Removal .....	10
1-2. Chassis Assembly Removal .....	10
1-3. Service Position .....	10
1-4. Picture Tube Removal .....	11
Anode Cap Removal Procedure.....	11
<b>2. Set-up Adjustments</b>	
2-1. Beam Landing .....	12
2-2. Convergence .....	13
2-3. Focus.....	15
2-4. Screen (G2).....	15
2-5. White Balance Adjustments.....	15
<b>3. Safety Related Adjustments</b>	
3-1. <input checked="" type="checkbox"/> R530, R531 Confirmation Method (Hold-Down Confirmation) and Readjustments .....	16
3-2. B+ Voltage Confirmation and Adjustment .....	16
<b>4. Circuit Adjustments</b>	
4-1. Setting Service Adjustment Mode.....	17
4-2. Memory Write Confirmation Method .....	17
4-3. Remote Adjustment Buttons and Indicators .....	17
4-4. Service Data Lists.....	18
4-5. ID Map Table .....	26
4-6. Board Adjustments .....	26
<b>5. Diagrams</b>	
5-1. Circuit Board Location .....	29
5-2. Printed Wiring Board and Schematic Diagrams Information .....	29
5-3. Block Diagram and Schematics.....	30
A Board Schematic Diagram .....	31
P Board Schematic Diagram .....	38
HS Board Schematic Diagram.....	40
C Board Schematic Diagram .....	41
V Board Schematic Diagram .....	43
GK Board Schematic Diagram.....	45
5-4. Semiconductors.....	47
<b>6. Exploded Views</b>	
6-1. Chassis (KV-27FS100/27FS200/29FS100 ONLY) .....	48
6-2. Picture Tube (KV-27FS100/27FS200/29FS100 ONLY).....	49
6-3. Chassis (KV-32FS100/32FS200/34FS100 ONLY) .....	50
6-4. Picture Tube (KV-32FS100/32FS200/34FS100 ONLY).....	51
<b>7. Electrical Parts List</b> .....	52

## SPECIFICATIONS

	KV-27FS100/ 27FS200 29FS100(N)	KV-32FS100 32FS200 34FS100(N)	KV-29FS100(S)	KV-34FS100(S)
<b>Power requirements</b>	120V, 60Hz		220V, 50/60Hz	
<b>Number of Inputs/Outputs</b>				
<b>Video</b> <sup>1)</sup>			3	
<b>S Video</b> <sup>2)</sup>			1	
<b>Y, P<sub>B</sub>, P<sub>R</sub></b> <sup>3)</sup>			1	
<b>Audio</b> <sup>4)</sup>			4	
<b>Audio Out</b> <sup>5)</sup>			1	
<b>Speaker output (W)</b>	10W x 2			
<b>Power Consumption (W)</b>				
<b>In use (Max)</b>	180W	190W	180W	190W
<b>In Standby</b>	1W	1W	1W	1W
<b>Dimensions(W/H/D)</b>				
<b>mm</b>	768 x 589 x 497 mm	898 x 696 x 576 mm	768 x 589 x 497 mm	898 x 696 x 576 mm
<b>in</b>	30 <sup>1/4</sup> x 23 <sup>1/4</sup> x 19 <sup>5/8</sup>	35 <sup>3/8</sup> x 27 <sup>3/8</sup> x 22 <sup>5/8</sup>	30 <sup>1/4</sup> x 23 <sup>1/4</sup> x 19 <sup>5/8</sup>	35 <sup>3/8</sup> x 27 <sup>3/8</sup> x 22 <sup>5/8</sup>
<b>Mass</b>				
<b>kg</b>	49.5 kg	75 kg	49.5 kg	75 kg
<b>lbs</b>	109 lbs. 2 oz.	165 lbs. 6 oz.	109 lbs. 2 oz.	165 lbs. 6 oz.

### Television system

American TV standard, NTSC

### Channel coverage

VHF: 2-13/ UHF: 14-69/ CATV: 1-125

### Picture tube

FD Trinitron<sup>®</sup> tube

### Visible screen size

27 inch picture measured diagonally (KV-27FS100/27FS200/29FS100)

32 inch picture measured diagonally (KV-32FS100/32FS200/34FS100)

### Actual screen size

29 inch measured diagonally (KV-27FS100/27FS200/29FS100)

34 inch measured diagonally (KV-32FS100/32FS200/34FS100)

### Antenna

75-ohm external antenna terminal for VHF/UHF

### Supplied Accessories

Size AA (R6) batteries (2)

Remote Control RM-Y180 (1) (KV-27FS100/29FS100/32FS100/34FS100)

Remote Control RM-Y181 (1) (KV-27FS200/32FS200)

### Optional Accessories

TV Stand: SU-27FD5 for (KV-27FS100/27FS200/29FS100)

SU-32FD4 for (KV-32FS100/32FS200/34FS100)

- 1) 1 Vp-p 75 ohms unbalanced, sync negative
- 2) Y: 1 Vp-p 75 ohms unbalanced, sync negative  
C: 0.286 Vp-p (Burst signal), 75 ohms
- 3) Y: 1.0 Vp-p, 75 ohms, sync negative;  
PB: 0.7 Vp-p, 75 ohms  
PR: Vp-p, 75 ohms
- 4) 500 mVrms (100% modulation), Impedance: 47 kilohms
- 5) More than 408 mVrms at the maximum volume setting (variable)  
More than 408 mVrms (fix)



## WARNINGS AND CAUTIONS

### CAUTION

Short circuit the anode of the picture tube and the anode cap to the metal chassis, CRT shield, or carbon painted on the CRT, after removing the anode.

### WARNING!!

An isolation transformer should be used during any service to avoid possible shock hazard, because of live chassis. The chassis of this receiver is directly connected to the ac power line.



### SAFETY-RELATED COMPONENT WARNING!!

Components identified by shading and  mark on the schematic diagrams, exploded views, and in the parts list are critical for safe operation. Replace these components with Sony parts whose part numbers appear as shown in this manual or in supplements published by Sony. Circuit adjustments that are critical for safe operation are identified in this manual. Follow these procedures whenever critical components are replaced or improper operation is suspected.

---

### ATTENTION!!

Après avoir déconnecté le cap de l'anode, court-circuiter l'anode du tube cathodique et celui de l'anode du cap au châssis métallique de l'appareil, ou la couche de carbone peinte sur le tube cathodique ou au blindage du tube cathodique.

Afin d'éviter tout risque d'électrocution provenant d'un châssis sous tension, un transformateur d'isolement doit être utilisé lors de tout dépannage. Le châssis de ce récepteur est directement raccordé à l'alimentation du secteur.



### ATTENTION AUX COMPOSANTS RELATIFS A LA SECURITE!!

Les composants identifiés par une trame et par une marque  sur les schémas de principe, les vues explosées et les listes de pièces sont d'une importance critique pour la sécurité du fonctionnement. Ne les remplacer que par des composants Sony dont le numéro de pièce est indiqué dans le présent manuel ou dans des suppléments publiés par Sony. Les réglages de circuit dont l'importance est critique pour la sécurité du fonctionnement sont identifiés dans le présent manuel. Suivre ces procédures lors de chaque remplacement de composants critiques, ou lorsqu'un mauvais fonctionnement suspecte.

## SAFETY CHECK-OUT

After correcting the original service problem, perform the following safety checks before releasing the set to the customer:

1. Check the area of your repair for unsoldered or poorly soldered connections. Check the entire board surface for solder splashes and bridges.
2. Check the interboard wiring to ensure that no wires are "pinched" or touching high-wattage resistors.
3. Check that all control knobs, shields, covers, ground straps, and mounting hardware have been replaced. Be absolutely certain that you have replaced all the insulators.
4. Look for unauthorized replacement parts, particularly transistors, that were installed during a previous repair. Point them out to the customer and recommend their replacement.
5. Look for parts which, though functioning, show obvious signs of deterioration. Point them out to the customer and recommend their replacement.
6. Check the line cords for cracks and abrasion. Recommend the replacement of any such line cord to the customer.
7. Check the B+ and HV to see if they are specified values. Make sure your instruments are accurate; be suspicious of your HV meter if sets always have low HV.
8. Check the antenna terminals, metal trim, "metallized" knobs, screws, and all other exposed metal parts for AC leakage. Check leakage as described below.

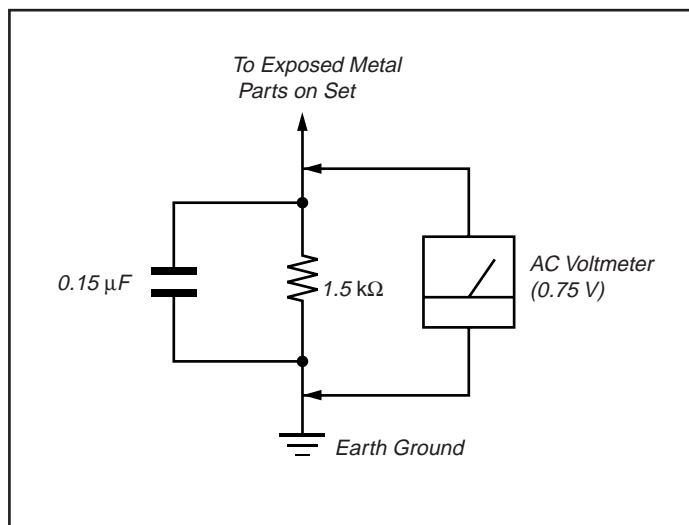

Figure A. Using an AC voltmeter to check AC leakage.

### Leakage Test

The AC leakage from any exposed metal part to earth ground and from all exposed metal parts to any exposed metal part having a return to chassis, must not exceed 0.5 mA (500 microamperes). Leakage current can be measured by any one of three methods.

1. A commercial leakage tester, such as the Simpson 229 or RCA WT-540A. Follow the manufacturers' instructions to use these instructions.
2. A battery-operated AC milliammeter. The Data Precision 245 digital multimeter is suitable for this job.
3. Measuring the voltage drop across a resistor by means of a VOM or battery-operated AC voltmeter. The "limit" indication is 0.75 V, so analog meters must have an accurate low voltage scale. The Simpson's 250 and Sanwa SH-63TRD are examples of passive VOMs that are suitable. Nearly all battery-operated digital multimeters that have a 2 VAC range are suitable (see Figure A).

### How to Find a Good Earth Ground

A cold-water pipe is a guaranteed earth ground; the cover-plate retaining screw on most AC outlet boxes is also at earth ground. If the retaining screw is to be used as your earth ground, verify that it is at ground by measuring the resistance between it and a cold-water pipe with an ohmmeter. The reading should be zero ohms.

If a cold-water pipe is not accessible, connect a 60- to 100-watt trouble-light (not a neon lamp) between the hot side of the receptacle and the retaining screw. Try both slots, if necessary, to locate the hot side on the line; the lamp should light at normal brilliance if the screw is at ground potential (see Figure B).

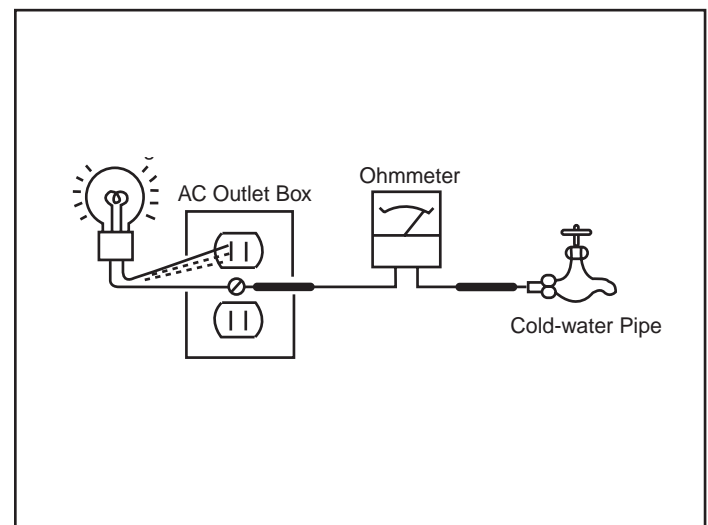

Figure B. Checking for earth ground.

## SELF-DIAGNOSTIC FUNCTION



The units in this manual contain a self-diagnostic function. If an error occurs, the STANDBY/TIMER LED will automatically begin to flash. The number of times the LED flashes translates to a probable source of the problem. A definition of the STANDBY/TIMER LED flash indicators is listed in the instruction manual for the user's knowledge and reference. If an error symptom cannot be reproduced, the Remote Commander can be used to review the failure occurrence data stored in memory to reveal past problems and how often these problems occur.

### Diagnostic Test Indicators

When an error occurs, the STANDBY/TIMER LED will flash a set number of times to indicate the possible cause of the problem. If there is more than one error, the LED will identify the first of the problem areas.

Results for all of the following diagnostic items are displayed on screen. If the screen displays a "0", an error has occurred.

Diagnostic Item	No. of times STANDBY / TIMER lamp flashes	Probable Cause Location	Detected Symptoms
Power does not turn on	Does not light	<ul style="list-style-type: none"> <li>Power cord is not plugged in.</li> <li>Fuse is burned out (F601). (GK Board)</li> </ul>	<ul style="list-style-type: none"> <li>Power does not come on.</li> <li>No power is supplied to the TV.</li> <li>AC Power supply is faulty.</li> </ul>
+B overcurrent (OCP)*	2 times	<ul style="list-style-type: none"> <li>H.OUT (Q502) is shorted. (A Board)</li> <li>IC702 is shorted. (C Board)</li> </ul>	<ul style="list-style-type: none"> <li>Power does not come on.</li> <li>Load on power line shorted.</li> </ul>
+B overvoltage (OVP)	3 times	<ul style="list-style-type: none"> <li>IC501 is faulty. (A Board)</li> <li>If a high is supplied to pin 2 of IC501. (A Board)</li> </ul>	<ul style="list-style-type: none"> <li>Has entered standby mode.</li> </ul>
I-Prot	4 times	<ul style="list-style-type: none"> <li>+12V is not supplied. (A Board)</li> <li>IC561 is faulty. (A Board)</li> </ul>	<ul style="list-style-type: none"> <li>Has entered standby state after horizontal raster.</li> <li>Vertical deflection pulse is stopped.</li> <li>Power line is shorted or power supply is stopped.</li> </ul>
IK (AKB)	5 times	<ul style="list-style-type: none"> <li>Video OUT (IC561) is faulty. (A Board)</li> <li>IC702 is faulty. (C Board)</li> <li>Screen (G2) is improperly adjusted. **</li> </ul>	<ul style="list-style-type: none"> <li>No raster is generated.</li> <li>CRT Cathode current detection reference pulse output is small.</li> </ul>
Zero Cross	9 times	<ul style="list-style-type: none"> <li>No zero cross pulses on pin 45 IC1001. (A Board)</li> </ul>	<ul style="list-style-type: none"> <li>Power does not come on.</li> </ul>
9V Check	10 times	<ul style="list-style-type: none"> <li>Relay failed (RY600)</li> </ul>	<ul style="list-style-type: none"> <li>Power does not come on.</li> </ul>

\* If a +B overcurrent is detected, stoppage of the vertical deflection is detected simultaneously. The symptom that is diagnosed first by the microcontroller is displayed on the screen.

\*\* Refer to Screen (G2) Adjustments in Section 2-4 of this manual

### Display of Standby/Timer LED Flash Count

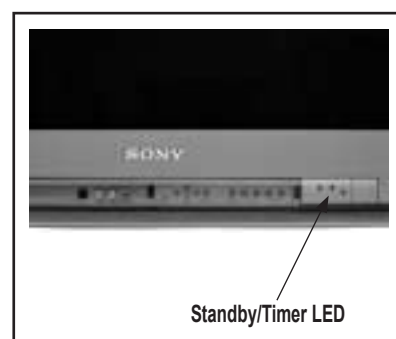
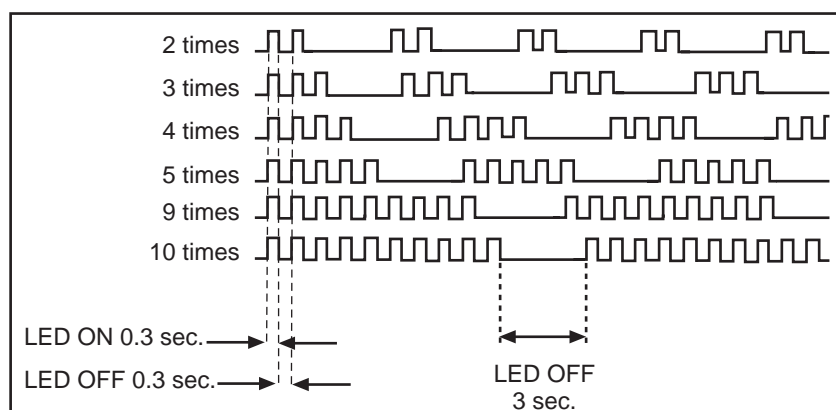

Diagnostic Item	Flash Count*
+B Overcurrent	2 times
+B Overvoltage	3 times
V-STOP	4 times
IK (AKB)	5 times
Zero Cross	9 times
9V	10 times

\*One flash count is not used for self-diagnostic.

### Stopping the Standby/Timer LED Flash

Turn off the power switch on the TV main unit or unplug the power cord from the outlet to stop the STANDBY/TIMER LAMP from flashing.

### Self-Diagnostic Screen Display

For errors with symptoms such as "power sometimes shuts off" or "screen sometimes goes out" that cannot be confirmed, it is possible to bring up past occurrences of failure on the screen for confirmation.

### To Bring Up Screen Test

In standby mode, press buttons on the Remote Commander sequentially, in rapid succession, as shown below:

**DISPLAY** → Channel **5** → Sound volume **0** → Power ON.

SELF DIAGNOSIS	
2: +B OCP	0
3: +B OVP	0
4: VSTOP	0
5: AKB	1
9: ZCD	0
10: 9VON	0
101: WDT	0
Serial: xxxxxxx	
Model: xxxxxxx	

Numeral "0" means that no fault was detected.  
Numerical "1" means a fault was detected one time only.

### Handling of Self-Diagnostic Screen Display

Since the diagnostic results displayed on the screen are not automatically cleared, always check the self-diagnostic screen during repairs. When you have completed the repairs, clear the result display to "0".

Unless the result display is cleared to "0", the self-diagnostic function will not be able to detect subsequent faults after completion of the repairs.

### Clearing the Result Display

To clear the result display to "0", press buttons on the Remote Commander sequentially when the diagnostic screen is displayed, as shown below:

Channel **8** → **ENTER**

### Quitting the Self-Diagnostic Screen

To quit the entire self-diagnostic screen, turn off the power switch on the Remote Commander or the main unit.

### Self-Diagnostic Circuit

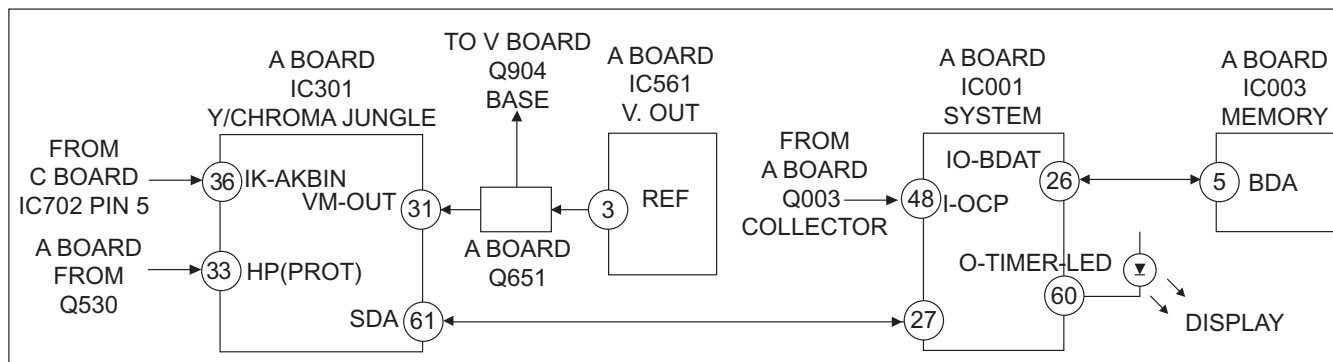

**+B overcurrent (OCP)**

Occurs when an overcurrent on the +B (135V) line is detected by pin 48 of IC001 (A Board). If the voltage of pin 48 of IC001 (A Board) is less than 1V when V.SYNC is more than seven verticals in a period, the unit will automatically turn off.

**+B overvoltage (OVP)**

Occurs when a high is felt on pin 2 of IC501 (A Board).

**I-PROT**

Occurs when an absence of the vertical deflection pulse is detected by pin 31 of IC301 (A Board). Power supply will shut down when waveform interval exceeds 2 seconds.

**IK (AKB)**

If the RGB levels\* do not balance within 2 seconds after the power is turned on, this error will be detected by IC301 (A Board). TV will stay on, but there will be no picture.

\*(Refers to the RGB levels of the AKB detection Ref pulse that detects 1K).

**Zero Cross**

Check Q691 collector (GK Board) 7.5V STBY goes to 0V when the set is turned on.

**9V Check**

Check Q691 collector (GK Board) 7.5V STBY goes to 0V when the set is turned on.

# SECTION 1: DISASSEMBLY

## 1-1. REAR COVER REMOVAL

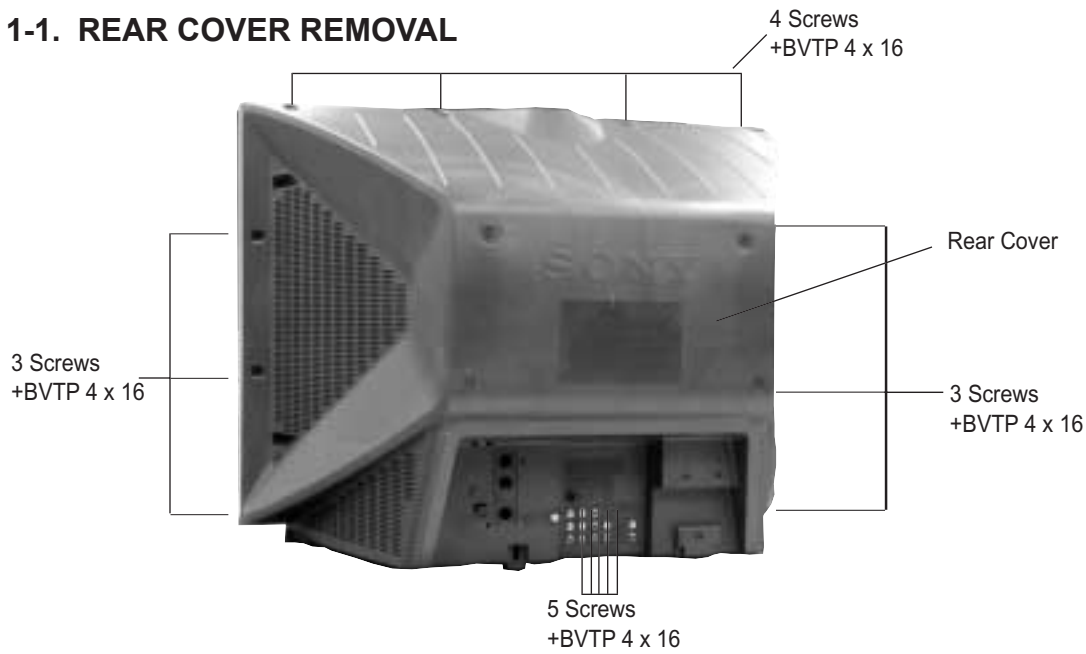

## 1-2. CHASSIS ASSEMBLY REMOVAL

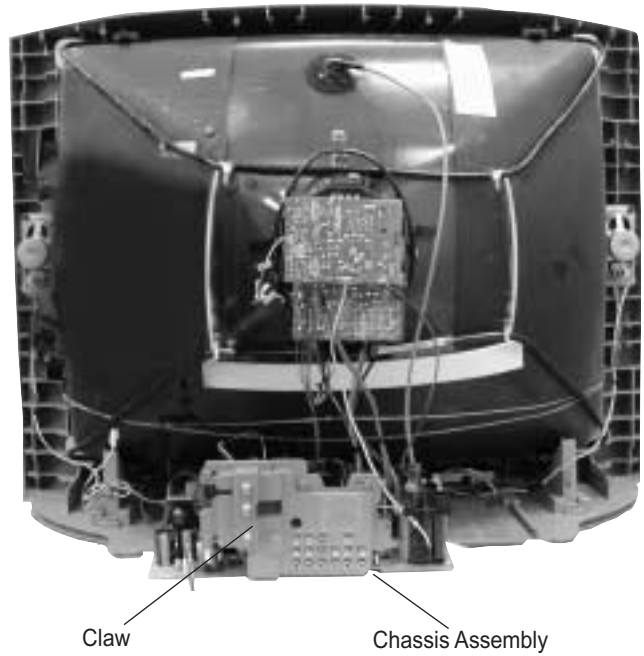

## 1-3. SERVICE POSITION

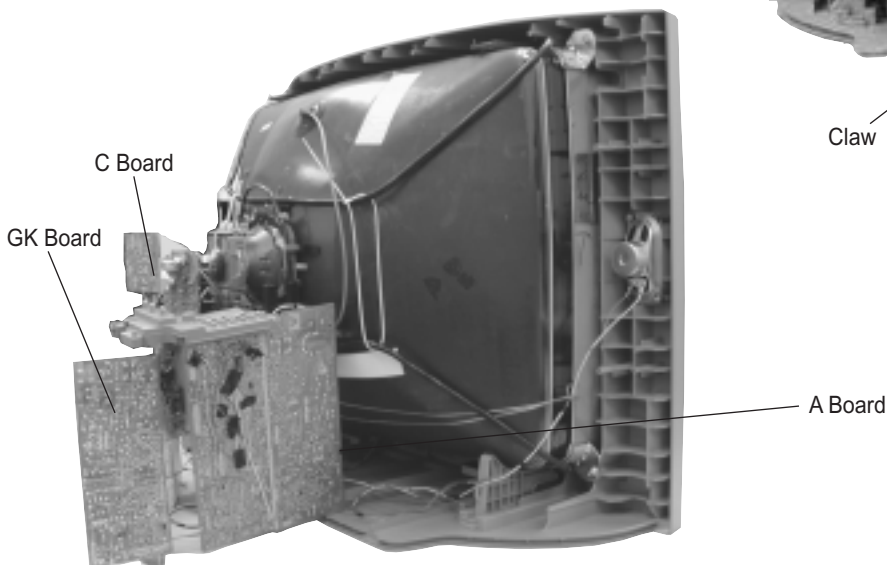

## 1-4. PICTURE TUBE REMOVAL

### WARNING: BEFORE REMOVING THE ANODE CAP

High voltage remains in the CRT even after the power is disconnected. To avoid electric shock, discharge CRT before attempting to remove the anode cap. Short between anode and CRT coated earth ground strap.

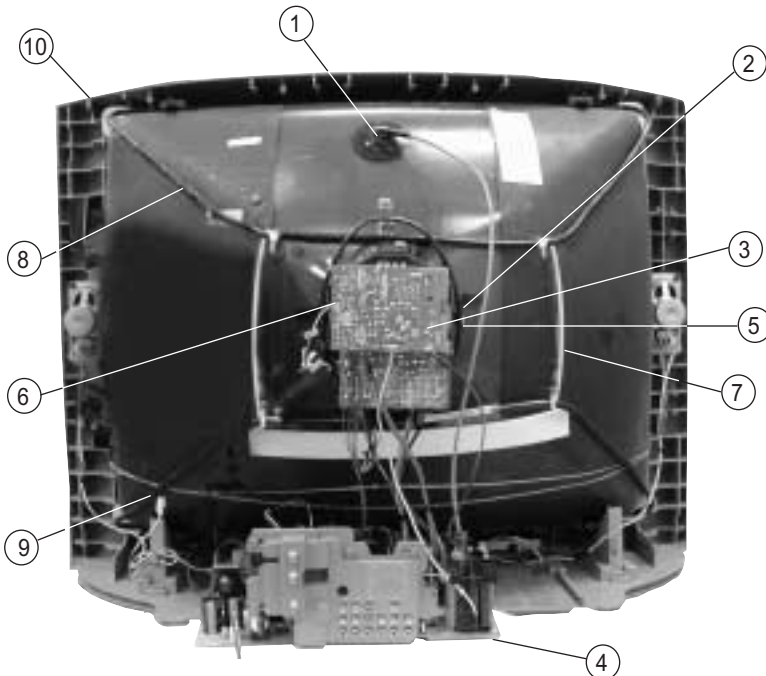
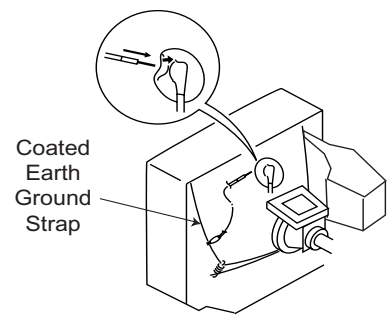

1. Discharge the anode of the CRT and remove the anode cap.
2. Unplug all interconnecting leads from the deflection yoke, neck assembly, degaussing coils and CRT grounding strap.
3. Remove the C Board from the CRT.
4. Remove the chassis assembly.
5. Loosen the neck assembly fixing screw and remove.
6. Loosen the deflection yoke fixing screw and remove.
7. Place the set with the CRT face down on a cushion and remove the degaussing coil holders.
8. Remove the degaussing coils.
9. Remove the CRT grounding strap and spring tension devices.
10. Unscrew the four CRT fixing screws [located on each CRT corner] and remove the CRT [Take care not to handle the CRT by the neck].

## ANODE CAP REMOVAL PROCEDURE

**WARNING:** High voltage remains in the CRT even after the power is disconnected. To avoid electric shock, discharge CRT before attempting to remove the anode cap. After removing the anode cap, short circuit to either the metal chassis, CRT shield, or carbon painted on the CRT.

**NOTE:** After removing the anode cap, short circuit the anode of the picture tube and the anode cap to either the metal chassis, CRT shield or carbon painted on the CRT.

### REMOVAL PROCEDURES

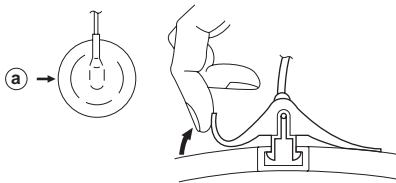

Turn up one side of the rubber cap in the direction indicated by arrow a .

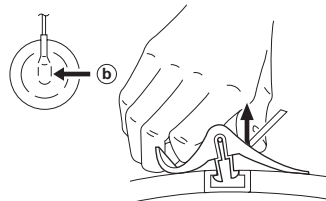

Use your thumb to pull the rubber cap firmly in the direction indicated by arrow b .

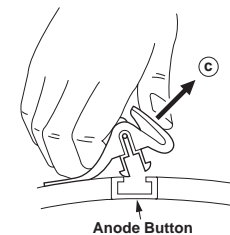

When one side of the rubber cap separates from the anode button, the anode cap can be removed by turning the rubber cap and pulling it in the direction of arrow c .

### HOW TO HANDLE AN ANODE CAP

1. Do not use sharp objects which may cause damage to the surface of the anode cap.
2. To avoid damaging the anode cap, do not squeeze the rubber covering too hard. A material fitting called a shatter-hook terminal is built into the rubber.
3. Do not force turn the foot of the rubber cover. This may cause the shatter-hook terminal to protrude and damage the rubber.

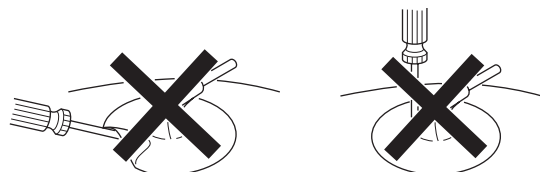

## SECTION 2: SET-UP ADJUSTMENTS

The following adjustments should be made when a complete realignment is required or a new picture tube is installed. These adjustments should be performed with rated power supply voltage unless otherwise noted.

The controls and switch should be set as follows unless otherwise noted:

PICTURE CONTROL: normal  
BRIGHTNESS CONTROL: normal

**Perform the adjustments in order as follows:**

1. Beam Landing
2. Convergence
3. Focus
4. Screen (G2)/White Balance

**Test Equipment Required:**

1. Color Bar Pattern Generator
2. Degausser
3. DC Power Supply
4. Digital Multimeter
5. Oscilloscope
6. CRT Analyzer

### 2-1. BEAM LANDING

**Preparation:**

- Input a white pattern signal.
- Face the picture tube in an East or West direction to reduce the influence of geomagnetism.

**NOTE: Do not use the hand degausser; it magnetizes the CRT .**

1. Input white pattern from pattern generator.
2. Loosen the deflection yoke mounting screw, and set the purity control to the center as shown below:

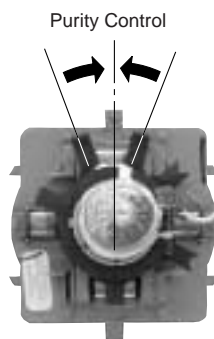

3. Input green pattern from pattern generator.
4. Move the deflection yoke backward, and adjust with the purity control so that green is in the center and red and blue are even on both sides.

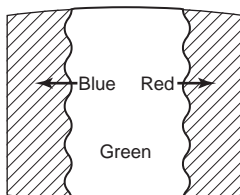

5. Move the deflection yoke forward, and adjust so that the entire screen becomes green.

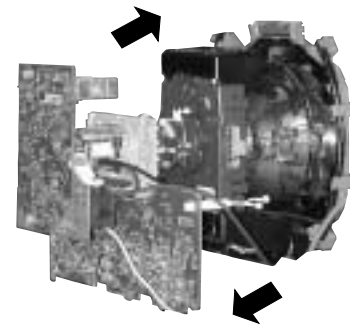

6. Switch over the raster signal to red and blue and confirm the condition.
7. When the position of the deflection yoke is determined, tighten it with the deflection yoke mounting screw.
8. When landing at the corner is not right, adjust by using the disk magnets.

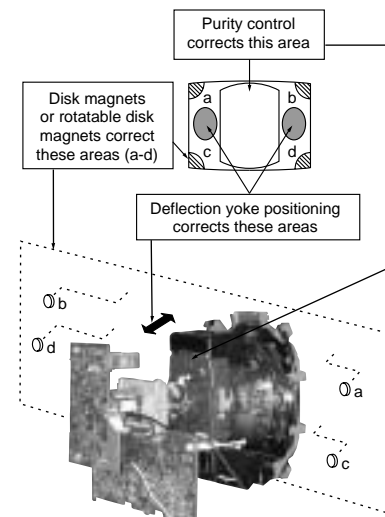



## 2-2. CONVERGENCE

### Preparation:

- Perform FOCUS, V. LIN and V. SIZE adjustments.
- Set BRIGHTNESS control to minimum.
- Input dot pattern.

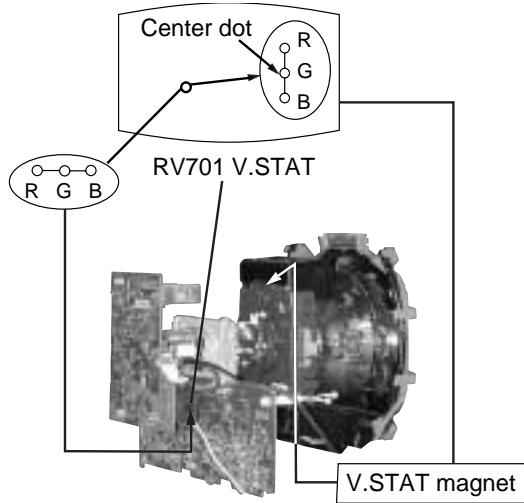

### VERTICAL AND HORIZONTAL STATIC CONVERGENCE

1. Adjust V. STAT magnet to converge red, green and blue dots in the center of the screen (Vertical movement).

Tilt the V. STAT magnet and adjust static convergence to open or close the V. STAT magnet.

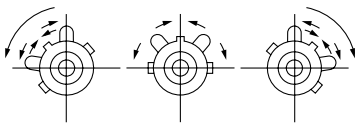

2. When the V. STAT magnet is moved in the direction of arrow a and b, red, green, and blue dots move as shown below:

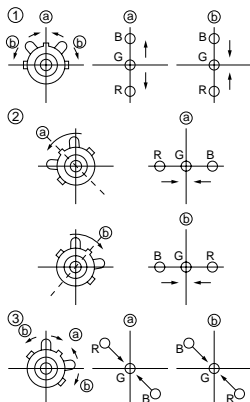

## OPERATION OF BMC (HEXAPOLE) MAGNET

The respective dot positions resulting from moving each magnet interact, so perform adjustment while tracking.

- 1 Use the V.STAT tabs to adjust the red, green, and blue dots so they line up at the center of the screen (move the dots in a horizontal direction).

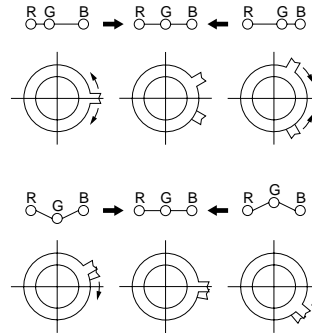

### Y SEPARATION AXIS CORRECTION MAGNET ADJUSTMENT

1. Input cross-hatch pattern, adjust PICTURE to minimum and BRIGHTNESS to normal.
2. Adjust the deflection yoke upright so it touches the CRT.
3. Adjust so that the Y separation axis correction magnet on the neck assembly is symmetrical from top to bottom (open state).

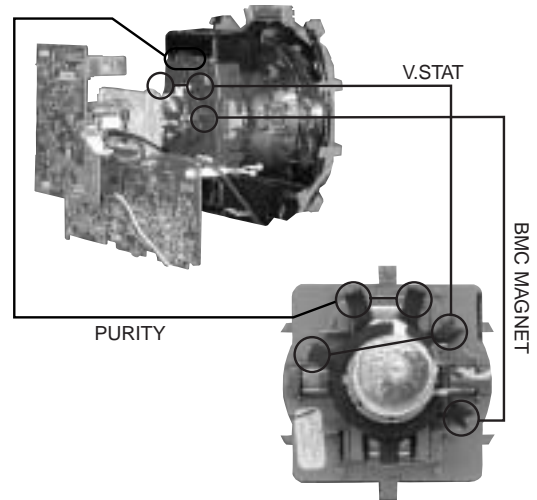

4. Return the deflection yoke to its original position.

## DYNAMIC CONVERGENCE ADJUSTMENT

Before starting, perform Vertical and Horizontal Static Convergence Adjustment.

1. Slightly loosen deflection yoke screw.
2. Remove deflection yoke spacers.
3. Move the deflection yoke for best convergence as shown below:

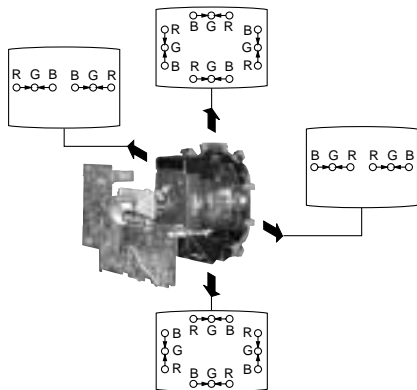

4. Tighten the deflection yoke screw.
5. Install the deflection yoke spacers.

## SCREEN-CORNER CONVERGENCE

1. Affix a permalloy assembly corresponding to the misconverged areas:

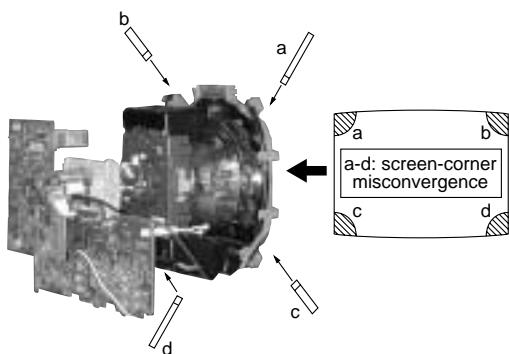

## TLH PLATE ADJUSTMENT

### Preparation:

- Input crosshatch pattern.
- Adjust Picture Quality to standard, Picture and Brightness to 50%, and Other to standard.
- Adjust the Horizontal Convergence of red and blue dots by tilting the TLH plate on the deflection yoke.

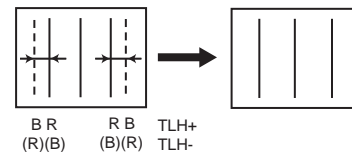
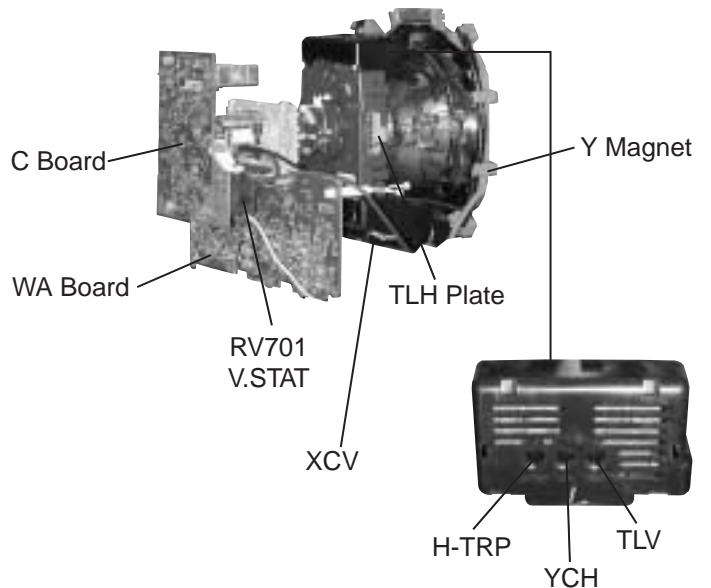

1. Adjust XCV core to balance X axis.
2. Adjust YCH VR to balance Y axis.
3. Adjust vertical red and blue convergence with V.TILT (TLV VR.) Perform adjustments while tracking items 1 and 2.
4. Adjust Y MAGNET to correct V.BOW Geometry Distortion.
5. Adjust H-TRP to correct H.Trapezoid Geometry Distortion.

After adjusting items 4 and 5, confirm overall geometry again.

## 2-3. FOCUS

1. Input monoscope signal.
2. Set user controls to normal.
3. Set video mode to STANDARD.
4. Set the PICTURE to maximum.
5. Adjust at 325 Mark for best center/corner focus balance.
6. Receive an entire white signal. Make sure Magenta Ring is at an acceptable level.

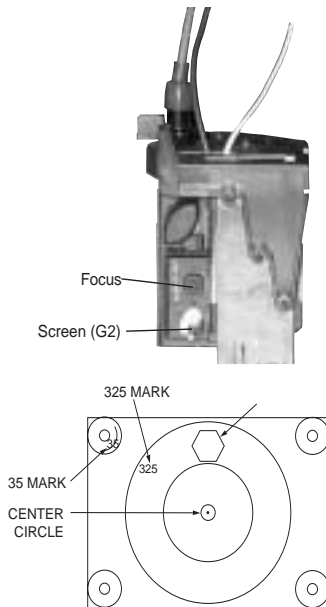

## 2-4. SCREEN (G2)

1. Input dot pattern from the pattern generator.
2. Set the user controls to NORMAL.
3. Attach the G2-Jig to the C Board.
4. Adjust RCUT, GCUT, BCUT, and SBRT in service mode with an oscilloscope so that voltages on the red, green, and blue cathodes are  $170 \pm 4.0\text{Vdc}$ .
5. Observe the screen and adjust SCREEN (G2) VR to obtain the faintly visible background of dot signal.
6. Push the TEST + JUMP (+ Channel) to cut off the signal. The screen should be bright or dark. Brightness of raster must be increased when adjusting.
7. Adjust screen VR until the screen is slightly cut off, or scarcely lights up. A signal cannot be seen when the brightness of the raster is high.
8. Push the JUMP again to release the cut off.

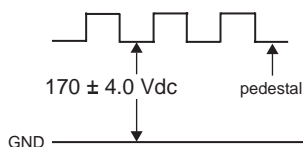

## 2-5. WHITE BALANCE ADJUSTMENTS

Adj.	NO.	Disp.	Item	All Models
VID_ADJ	0	RDRV	Red Drive	41
VID_ADJ	1	GDRV	Green Drive	32
VID_ADJ	2	BDRV	Blue Drive	29
VID_ADJ	3	RCUT	Red Cut-off	31
VID_ADJ	4	GCUT	Green Cut-off	14
VID_ADJ	5	BCUT	Blue Cut-off	17
VP2	4	SBRT	Sub Bright	16

1. Set program palette to STANDARD and push RESET.
2. Input an entire white signal.
3. Set to Service Adjustment Mode.
4. Set the PICTURE and BRIGHT to minimum.
5. Adjust with SBRT if necessary.
6. Set RCUT to "14".
7. Select GCUT and BCUT with **3** and **5**.
8. Adjust by pressing **1** and **4** for the best white balance.
9. Set the PICTURE and BRIGHT to maximum.
10. Select GDRV and BDRV with **1** and **2**.
11. Adjust with **3** and **6** for the best white balance.
12. Write into the memory by pressing **3** then **5**.
13. Repeat steps 1-12 for GDR4, BDR4, GCU4 and BCU4 using Video 4 input.



\* Use values from Sub Contrast Adjustments

**White balance should be adjusted after Sub Contrast because RDRV is also used in Sub Contrast Adjustment. (See page 22).**

## SECTION 3: SAFETY RELATED ADJUSTMENTS

### 3-1. R530, R531 CONFIRMATION METHOD (HOLD-DOWN CONFIRMATION) AND READJUSTMENTS

Always perform the following adjustments when replacing the following components marked with a  mark on the schematic diagram:

Part Replaced (  )	Adjustment (  )
<b>A BOARD:</b> R550, T503, T504, D519, IC501, R533, D521, R532, D520, C531, R529, R530, R531, C532	<b>HV HOLD DOWN</b> R530, R531

### PREPARATION BEFORE CONFIRMATION

- Using a Variac, apply AC input voltage: 120 +/- 2.0 VAC.
- Turn the POWER switch ON.
- Input a white signal and set the PICTURE and BRIGHT controls to maximum.
- Confirm that the voltage of more than 23.0 VDC appears between TP85 and ground on the A Board.

### HOLD-DOWN OPERATION CONFIRMATION

- Connect the current meter between Pin 11 of the FBT (T503) and the PWB land where Pin 11 would normally attach. (See Figure 1).
- Input a dot signal and set PICTURE and BRIGHTNESS to minimum: IABL = 2175 + 100/ -325  $\mu$ A.
- Confirm the voltage of A Board TP91 is 135  $\pm$  1.5 VDC.
- Connect the digital voltmeter and the DC power supply to TP85 and ground. (See Figure 1 above).
- Increase the DC power voltage gradually until the picture blanks out.
- Turn DC power source off immediately.
- Read the digital voltmeter indication (standard = 27.24 + 0.0/ - 0.1 VDC).
- Input a white signal and set PICTURE and BRIGHTNESS to maximum: IABL = 2175 + 100/ -325  $\mu$ A.
- Repeat steps 4 to 7.

### HOLD-DOWN READJUSTMENT

If the setting indicated in Step 2 of Hold-Down Operation Confirmation cannot be met, readjustment should be performed by altering the resistance value of R530, R531 component marked with .

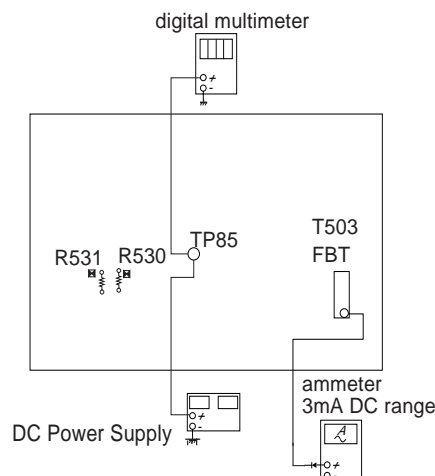



Figure 1

### 3-2. B+ VOLTAGE CONFIRMATION AND ADJUSTMENT

Always perform the following adjustments when replacing the following components, which are marked with  on the schematic diagram on the GK Board:

**GK BOARD:** IC600, PH602

- Using a Variac, apply AC input voltage: 130 + 2.0/-0.0 VAC
- Input a monoscope signal.
- Set the PICTURE control and the BRIGHT control to minimum.
- Confirm the voltage on A Board between TP23 and ground is less than 136.5 VDC.
- If step 4 is not satisfied, replace R530 and R531 on A Board and repeat the above steps.

## SECTION 4: CIRCUIT ADJUSTMENTS

### ELECTRICAL ADJUSTMENTS BY REMOTE COMMANDER

Use the Remote Commander (RM-Y180, RM-Y181) to perform the circuit adjustments in this section.

**Test Equipment Required:** 1. Pattern generator 2. Frequency counter 3. Digital multimeter 4. Audio oscillator

#### 4-1. SETTING SERVICE ADJUSTMENT MODE

- Standby mode (Power off).
- Press the following buttons on the remote commander within a second of each other:

**DISPLAY** → Channel **5** → Sound Volume **+** → Power

#### SERVICE ADJUSTMENT MODE IN

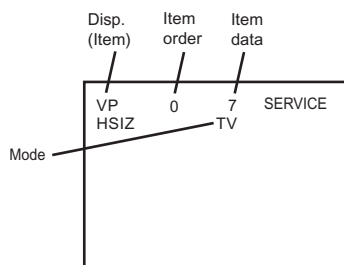

- The CRT displays the item being adjusted.
- Press **1** or **2** on the Remote Commander to select the item.
- Press **3** or **6** on the Remote Commander to change the data.
- Press **MUTING** then **ENTER** to write into memory.

#### SERVICE ADJUSTMENT MODE MEMORY

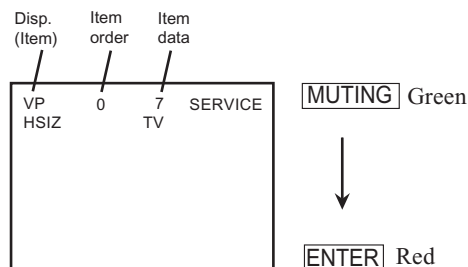

- Press then on the Remote Commander to initialize.

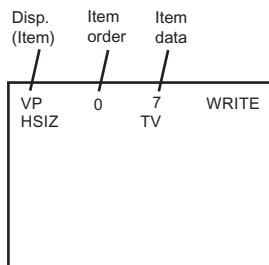

Carry out Step 1 when adjusting ID's 0-7 and when replacing and adjusting IC003.

- DO NOT turn off set until **SERVICE** appears.

#### 4-2. MEMORY WRITE CONFIRMATION METHOD

- After adjustment, pull out the plug from the AC outlet, then replace the plug in the AC outlet again.
- Turn the power switch ON and set to Service Mode.
- Call the adjusted items again to confirm they were adjusted.

#### 4-3. REMOTE ADJUSTMENT BUTTONS AND INDICATORS

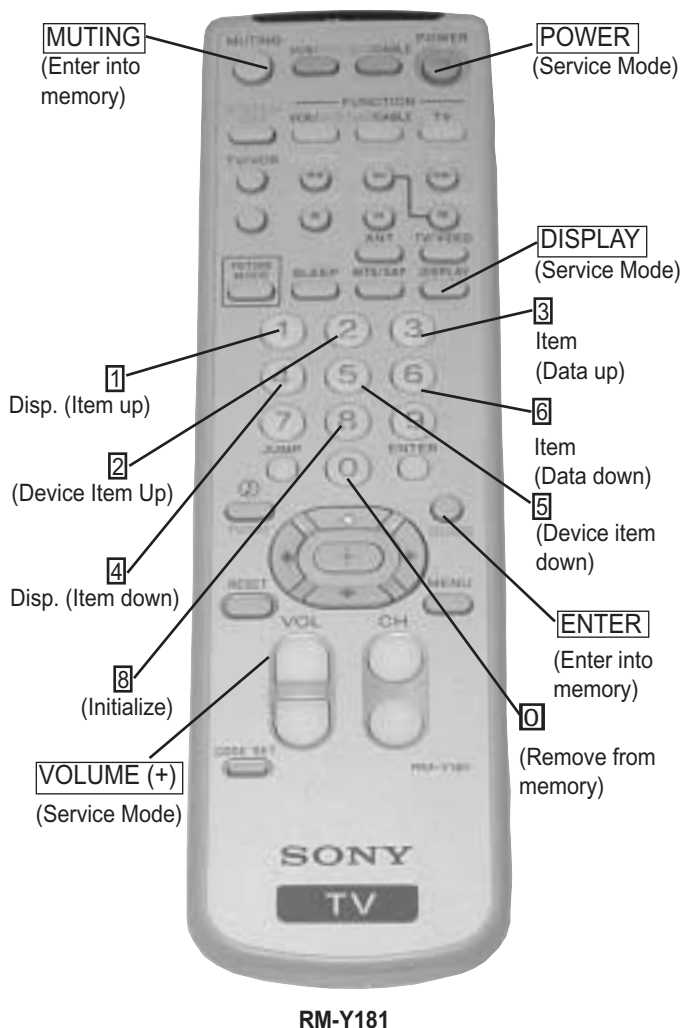

RM-Y181

## 4-4. SERVICE DATA LISTS

## Non-Volatile Memory (NVM) Reference for BA5D Service List

Service Group	No.	Name	Description	Common		
				Slave Addr	Sub Addr	Init Data
VERSION	0	VER	Microprocessor version information	=	=	0

Service Group	No.	Name	Fix / Var	Description	Common				NTSC / PAL-M			PAL-N		
					Slave Addr	Sub Addr	Fix Data	Var Data	Slave Addr	Sub Addr	Data	Slave Addr	Sub Addr	Data
VP1	0	HSIZ	Var	H SIZE (11 / 2-7)					A4	A8		A4	B4	
	1	HPOS	Var	HPOS (12 / 2-7)					A4	A9		A4	B5	
	2	VBOW	Var	AFC BOW (16 / 4-7)					A4	AE		A4	BA	
	3	VANG	Var	AFC ANGLE (16 / 0-3)					A4	AE		A4	BA	
	4	VTRP	Var	TRAPEZIUM (20 / 3-7)					A4	AF		A4	BB	
	5	HTRP	Var	H. TRAPEZOID (15 / 4-7)					A4	AD		A4	B9	
	6	TROT	Fix	TILT ROTATION (0-63)					A4	A4		A4	B0	
	7	PAMP	Var	PIN AMP (13 / 2-7)					A4	AA		A4	B6	
	8	UPIN	Var	UP-CPIN (14 / 2-7)					A4	AB		A4	B7	
	9	LPIN	Var	LO-CPIN (1C / 2-7)					A4	AC		A4	B8	
	10	VSIZ	Var	V SIZE (0E / 2-7)					A4	A5		A4	B1	
	11	VPOS	Var	V POSITION (0E / 2-7)					A4	A6		A4	B2	
	12	VLIN	Var	V LINEARITY (10 / 0-3)					A4	A7		A4	B3	
	13	SCOR	Var	S CORRECTION (10 / 4-7)					A4	A7		A4	B3	
	14	VZOM	Fix	16:9 CRT Z Mode on/off	A4	85								
	15	EHT	Fix	Vertical High-Voltage Compensation	A4	80								
	16	ASP	Fix	Aspect Ratio control (4:3 Mode)	A4	FB	47							
	17	ASP1	Fix	Aspect Ratio control (16:9 Mode)	A4	FC	47							
	18	SCRL	Fix	16:9 CRT Z Mode Trans. Scroll	A4	86								
	19	HBLK	Fix	Horizontal Blanking on/off	A4	85								
	20	LBLK	Fix	Left Blanking Adjustment	A4	80								
	21	RBLK	Fix	Righ Blanking Adjustment	A4	81								
	22	HDW	Fix	Horizontal Drive Pulse Width	A4	85								
	23	EWDC	Fix	"Parabola" EW, D.C. Adjustment	A4	88								
	24	LVLN	Fix	Lower Screen BTM Vertical Line Adj.	A4	81								
	25	UVLN	Fix	Uppe Screen BTM Vertical Line Adj.	A4	82								
	26	INTL	Fix	INTERLACE	A4	84								
	27	HOSC	Fix	Horizontal VCO Oscillation Freq.	A4	82								
	28	VSS	Fix	Vertical Sync Slice Level	A4	84								
	29	HSS	Fix	Horizontal Sync Slice Level	A4	88								
	30	HMSK	Fix	For Macro Vision	A4	88								
	31	VTMS	Fix	Select Signal VTIM Pin	A4	85								
	32	TCMD	Fix	Vertical Count Down Mode Switching (for TV)	A4	8C								
	33	VCMD	Fix	Vertical Count Down Mode Switching (for Video)	A4	8D								
	34	AFC	Fix	AFC Loop Gain Switching	A4	86								
	35	FIFR	Fix	Field Frequency	A4	87								
	36	VBLK	Fix	VBLKW	A4	88								
37	HTSW	Fix	H-Trap Switch : NEW	A4	88									

## SERVICE DATA LISTS

Service Group	No.	Name	Fix / Var	Description	Common				NTSC			PAL-M			PAL-N		
					Slave Addr	Sub Addr	Fix Data	Var Data	Slave Addr	Sub Addr	Data	Slave Addr	Sub Addr	Data	Slave Addr	Sub Addr	Data
VP2	0	REFP	Fix	REFP	A4	88	0										
	1	JPSW	Fix	Jump SW	=	=											
	2	SHUE	Var	Sub HUE adjustment	A4	8C											
	3	SCOL	Var	Sub COLOR adjustment					A4	8E		A4	90	7	A4	92	
	4	SBRT	Var	Sub BRIGHTNESS adjustment	A4	87											
	5	AXPL	Fix	Axis PAL	A4	89	0										
	6	AXNT	Fix	Axis NTSC	A4	89	1										
	7	CBPF	Fix	Chroma BPF on/off	A4	89	1										
	8	CTRP	Fix	Y TRAP FILTER on/off	=	=											
	9	COFF	Fix	Color On/off	=	=											
	10	KOFF	Fix	Set Color Killer	A4	89	0										
	11	SSHP	Fix	Sub SHARPNESS	A4	83											
	12	TSPF	Fix	SHARPNESS Circuit Fo (for TV)	A4	8C											
	13	VSPF	Fix	SHARPNESS Circuit Fo (for Video)	A4	8D											
	14	PREL	Fix	Pre-Shoot/ Over-Shoot	A4	89	1										
	15	ABLM	Fix	ABL Mode Switch	A4	89	1										
	16	VTH	Fix	ABL CD VHT Switching	=	=											
	17	YDEL	Fix	Y Delay Time Control	A4	84											
	18	NCOL	Fix	No Color ID	A4	85											
	19	FSC	Fix	FSC Out on/off	A4	85	1										
20	KID	Fix	Killer ID Control on/off	A4	85	0											

Service Group	No.	Name	Fix / Var	Description	Common				NTSC			PAL-M			PAL-N		
					Slave Addr	Sub Addr	Fix Data	Var Data	Slave Addr	Sub Addr	Data	Slave Addr	Sub Addr	Data	Slave Addr	Sub Addr	Data
VID_ADJ	0	RDRV	var	R DRIVE (0A / 7-2)	A4	9E	41										
	1	GDRV	Var	G DRIVE (0B / 7-2)	A4	9F											
	2	BDRV	Var	B DRIVE (0C / 7-2)	A4	A0											
	3	RCUT	Var	R CUT OFF ( 07 / 7-2)	A4	A1	31										
	4	GCUT	Var	G CUT OFF (08 / 7-2)	A4	A2											
	5	BCUT	Var	B CUT OFF (09 / 7-2)	A4	A3											
	6	SCON	Var	Sub Contrast adjusment	A4	8A											
	7	CHUE	Var	Sub HUE adjustment for TV	A4	94	16										
	8	CCOL	Var	Sub COLOR adjustment for TV					A4	8F	18	A4	91	18	A4	93	23
	9	UOFS	Var	YUV U offset	A4	8B											
	10	VOFS	Var	YUV V offset	A4	8B											
	11	RON	Fix	R ON (01 / 3)	=	=											
	12	GON	Fix	G ON (01 / 2)	=	=											
	13	BON	Fix	B ON (01 / 1)	=	=											
	14	HUEV	Var	Sub HUE adjustment for Video	A4	8D											
15	COLV	Var	Sub COLOR adjustment for Video					A4	8E		A4	90		A4	92		

## SERVICE DATA LISTS

Service Group	No.	Name	Fix / Var	Description	Common		
					Slave Addr	Sub Addr	Fix Data
COL_TMP	0	GDOF	Fix	G DRIVE Offset	A4	9A	4
	1	BDOF	Fix	B DRIVE Offset	A4	9B	15
	2	GCOF	Fix	G CUT Offset	A4	9C	7
	3	BCOF	Fix	B CUT Offset	A4	9D	14
	4	DCOL	Fix	Dinamic Color	=	=	

Service Group	No.	Name	Fix / Var	Description	Common		
					Slave Addr	Sub Addr	Fix Data
PIC_IMP	0	BLAD	Fix	Black area detect (01 / 6-7)	A4	09	0
	1	SRTS	Fix	SRT level (01 / 4-5)	A4	09	3
	2	YNR	Fix	YNR(01 / 2)	A4	09	1
	3	GIRE	Fix	Gamma correction(01 / 0-1)	A4	09	3
	4	DAC1	Fix	DAC1(02 / 7)	A4	0A	0
	5	DAC2	Fix	DAC2(02 / 6)	A4	0A	0
	6	VMGA	Fix	VM on 1226 (02/5-4)	A4	0A	0
	7	GCUR	Fix	Gamma curve(02 / 2)	A4	0A	1
	8	BLKC	Fix	Black Compensation (02 / 1)	A4	0A	1
	9	TEST	Fix	TEST(03 / 6-7)	A4	0B	3
	10	RS	Fix	RS (03 / 3-5)	A4	0B	0
	11	RTC	Fix	RTC(03 / 0-2)	A4	0B	2
	12	APAC	Fix	APAC	A4	0B	0
	13	SRTH	Fix	SRT bit for Dynablack = High	A4	5C	1
	14	SRTL	Fix	SRT bit for Dynablack = Low	A4	5D	1
	15	SRTLO	Fix	SRT bit for Dynablack = Off	A4	5E	0
	16	SHPH	Fix	Sharpness level for Dynablack = High	A4	5C	54
	17	SHPL	Fix	Sharpness level for Dynablack = Low	A4	5D	43
18	SHPO	Fix	Sharpness level for Dynablack = Off	A4	5E	0	

Service Group	No.	Name	Fix / Var	Description	Palette = VIVID			Palette = STANDARD			Palette = MOVIE			Palette = SPORTS		
					Slave Addr	Sub Addr	Fix Data	Slave Addr	Sub Addr	Fix Data	Slave Addr	Sub Addr	Fix Data	Slave Addr	Sub Addr	Fix Data
PALETTE	0	VPIC	Fix	User picture setting 0:min, 63: max	A4	5F	63	A4	65	50	A4	6B	38	A4	71	63
	1	VBRT	Fix	User brightness setting 0:min, 63: max	A4	60	31	A4	66	31	A4	6C	31	A4	72	31
	2	VCOL	Fix	User color setting 0:min, 63: max	A4	61	35	A4	67	31	A4	6D	31	A4	73	40
	3	VSHP	Fix	User sharpness setting 0:min, 63: max	A4	62	31	A4	68	31	A4	6E	34	A4	74	31
	4	VVM	Fix	0: OFF, 1: Low, 2: High, 3: N/A	A4	5F	2	A4	65	1	A4	6B	0	A4	71	2
	5	VTRI	Fix	0: Cool, 1: Nutral, 2: Warm, 3: N/A	A4	60	0	A4	66	1	A4	6C	2	A4	72	0
	6	VGMA	Fix	0: OFF, 1: Low, 2: Mid, 3: Max	A4	63	2	A4	69	2	A4	6F	2	A4	75	2
	7	VNRM	Fix	0: 3D, 1: 2D	A4	61	0	A4	67	0	A4	6D	0	A4	73	0
	8	VYDC	Fix	DC Transmission Ratio 0,1: 100%, 2: 92%, 3: 85	A4	62	3	A4	68	3	A4	6E	2	A4	74	3
	9	VVEN	Fix	Vertoca; Enhancement	A4	63	5	A4	69	3	A4	6F	3	A4	75	5
	10	VHK0	Fix	Horizontal Peaking 0:On, 1:Off	A4	61	0	A4	67	0	A4	6D	0	A4	73	0
	11	VDBK	Fix	User Dynablack 0: OFF, 1: Low, 2: High, 3: N/A	A4	63	2	A4	69	1	A4	6F	1	A4	75	1
12	VYPL	Fix	Y-Peaking Limit	A4	64	1	A4	6A	0	A4	70	0	A4	76	1	



## SERVICE DATA LISTS

Service Group	No.	Name	Fix / Var	Description	Common		
					Slave Addr	Sub Addr	Fix Data
3L_COMB	0	FUNN	Fix	Function (0 / 7-6) for NTSC	A4	3C	3
	1	FUNP	Fix	Function (0 / 7-6) for PAL-N, PAL-M	A5	3C	3
	2	DRNG	Fix	DRANG (0 / 2)	A4	3C	0
	3	YCSM	Fix	Y/C Sep Mode (0 / 1-0)	A4	3C	0
	4	CNRK	Fix	CNRK (1 / 7-6)	A4	3D	1
	5	CNRL	Fix	CNR Lim (1 / 5-4)	A4	3D	1
	6	CLPF	Fix	C-LPF(1 / 3)	A4	3D	1
	7	SLPF	Fix	SelC-LPF(1 / 2)	A4	3D	0
	8	MODE	Fix	Mode1 (1 / 1)	A4	3D	0
	9	YPG	Fix	Y - Peaking Gain (2 / 7-6)	A4	3E	3
	10	PDSC	Fix	Pds. Clip (2 / 3)	A4	3E	0
	11	YLPF	Fix	Y-LPF(2 / 2)	A4	3E	1
	12	VENL	Fix	V-Emph N.L (3 / 4-2)	A4	3F	4
13	VEC	Fix	V - Emph Core (3 / 1-0)	A4	3F	3	

Service Group	No.	Name	Fix / Var	Description	Common		
					Slave Addr	Sub Addr	Fix Data
3D_COMB	0	COUT	Fix	COUTS(00 / 2-3)	A4	21	3
	1	YAPS	Fix	YAPS(00 / 0-1)	A4	21	1
	2	NSDS	Fix	NSDS(01 / 4-5)	A4	22	0
	3	MSS	Fix	MSS(01 / 2-3)	A4	22	0
	4	KILS	Fix	KILS (01 / 1-0)	A4	22	1
	5	DYC	Fix	DYCOS ( 02 / 7-6)	A4	23	2
	6	EXAD	Fix	EXADINS(02 / 5)	A4	23	0
	7	EXCS	Fix	EXCSS(02 / 1-0)	A4	23	1
	8	CPP	Fix	CPP(03 / 6)	A4	24	0
	9	HDP	Fix	HDP(03 / 3-5)	A4	24	6
	10	CDL	Fix	CDL(03 / 0-2)	A4	24	6
	11	DYCO	Fix	DYCOR(04 / 4-7)	A4	25	2
	12	DYGA	Fix	DYGAIN(04 / 0-3)	A4	25	10
	13	DCCO	Fix	DCCOR(05 / 4-7)	A4	26	2
	14	DCGA	Fix	DCGAIN(05 / 0-3)	A4	26	9
	15	YNRL	Fix	YNRLIM(06 / 4-5)	A4	27	1
	16	CNRL	Fix	CNRLIM(06 / 0-1)	A4	27	1
	17	ID1O	Fix	ID1ON(07 / 7)	A4	28	0
	18	ID1W	Fix	ID1W0A1(07 / 6)	A4	28	0
	19	ID1N	Fix	ID1W0A2(07 / 5)	A4	28	0
	20	WSC	Fix	WSC(08 / 6-7)	A4	29	1
	21	VTRH	Fix	VTRH(08 / 4-5)	A4	29	1
	22	VTRR	Fix	VTRR(08 / 2-3)	A4	29	1
	23	LDSR	Fix	LDSR(08 / 0-1)	A4	29	2
	24	WSS	Fix	WSS ( 09 / 7 )	A4	2A	0
	25	ID1E	Fix	ID1ECON ( 09 / 6 )	A4	2A	1
	26	TT	Fix	TT ( 09 / 4 -5)	A4	2A	0
	27	FELC	Fix	FELCHK ( 09 / 3 )	A4	2A	1
	28	TH	Fix	TH ( 09 / 1 -2)	A4	2A	0
	29	VAPG	Fix	VAPGAIN(0A / 5-7)	A4	2B	3
30	VAPI	Fix	VAPINV(0A / 0-4)	A4	2B	25	

## SERVICE DATA LISTS

Service Group	No.	Name	Fix / Var	Description	Common		
					Slave Addr	Sub Addr	Fix Data
3D_COMB	31	YPFT	Fix	YPFT(0B / 4-5)	A4	2C	3
	32	YPFG	Fix	YPFG(0B / 0-3)	A4	2C	8
	33	V1PS	Fix	V1PS(0C / 6-7)	A4	2D	3
	34	VEGS	Fix	VEGS(0C / 4-5)	A4	2D	2
	35	CC3N	Fix	CC3N(0C / 3)	A4	2D	0
	36	C0HS	Fix	C0HS(0C / 2)	A4	2D	0
	37	SEL2	Fix	SELD2FH(0C / 0)	A4	2D	1
	38	SEL1	Fix	SELD1FL(0D / 5)	A4	2E	1
	39	YHCO	Fix	YHCOR(10 / 6-7)	A4	31	0
	40	YHCG	Fix	YHCGAIN(10 / 5)	A4	31	1
	41	OVST	Fix	+OVST(10 / 3)	A4	31	0
	42	CSHD	Fix	CSHDT(10 / 2)	A4	31	0
	43	KCTT	Fix	KCTT(10 / 0-1)	A4	31	0
	44	SHT	Fix	SHT(11 / 7-6)	A4	32	0
	45	VCT	Fix	VCT(11 / 5)	A4	32	0
	46	CGAT	Fix	CLKGAT ( 11 / 4)	A4	32	0
	47	CG2D	Fix	CLK2D ( 11 / 3)	A4	32	1
	48	CGGT	Fix	CLKGGT ( 11 / 2)	A4	32	0
	49	CGEB	Fix	CLKGEB ( 11 / 1)	A4	32	0
	50	CGT	Fix	CLKGT ( 11 / 0)	A4	32	0
	51	HPLL	Fix	HPLLFS(12 / 7)	A4	33	1
	52	BPLL	Fix	BPLLFS (12 / 6)	A4	33	0
	53	FSCF	Fix	FSCFG(12 / 5)	A4	33	0
	54	PLLF	Fix	PLLFG(12 / 4)	A4	33	1
	55	KILR	Fix	KILR(12 / 0-3)	A4	33	3
	56	HSSL	Fix	HSSL(13 / 4-7)	A4	34	12
	57	VSSL	Fix	VSSL(13 / 0-3)	A4	34	8
	58	BGPS	Fix	BGPS(14 / 4-7)	A4	35	4
	59	BGPW	Fix	BGPW(14 / 0-3)	A4	35	10
	60	ADCL	Fix	ADCLKS(15 / 6-7)	A4	36	3
	61	NSDW	Fix	NSDSW(15 / 4)	A4	36	1
	62	HIZE	Fix	HIZEN ( 16 / 4)	A4	37	0
	63	HCNT	Fix	HCNTFSYN ( 17 / 6)	A4	38	0

## SERVICE DATA LISTS

Service Group	No.	Name	Fix / Var	Description	Common		
					Slave Addr	Sub Addr	Fix Data
PIP	0	PFRN	Fix	VCXO oscilation	A4	40	0
	1	PRVS	Fix	HD/VD input synchronous mode selection	A4	40	1
	2	PCON	Fix	PIP sub contrast control	A4	41	97
	3	PUCO	Fix	PIP U level control	A4	42	5
	4	PVCO	Fix	PIP V level control	A4	43	17
	5	PHUE	Fix	PIP sub hue control	A4	57	12
	6	PKIL	Fix	Color killer	A4	42	0
	7	PSEP	Fix	C-sync sep input selection	A4	44	1
	8	PDCN	Fix	Sub pic sync sep. Thereshold setting	A4	44	3
	9	PBGS	Fix	bgp position setting	A4	45	15
	10	PDL0	Fix	Y/C delay adjust (for video)	A4	46	11
	11	PDL1	Fix	Y/C delay adjust (for yuv)	A4	46	13
	12	PBRT	Fix	Y bryghtness control	A4	48	25
	13	PVP1	Fix	V pedestal level for YUV	A4	49	0
	14	PUP1	Fix	U pedestal level for YUV	A4	49	0
	15	PVP2	Fix	V pedestal level for main w/ burst	A4	4A	0
	16	PUP2	Fix	U pedestal level for main w/ burst	A4	4A	0
	17	PVP3	Fix	V pedestal level for main w/o burst	A4	4B	0
	18	PUP3	Fix	U pedestal level for main w/o burst	A4	4B	0
	19	PACS	Fix	0D, 0Eh setting mode	A4	4C	1
	20	PSYS	Fix	Color system	=	=	
	21	PSDL	Fix	Sync delay control	A4	4C	0
	22	PCCL	Fix	YUV color level	A4	4D	11
	23	PCGA	Fix	Croma gain	A4	4D	0
24	PAAF	Fix	Auto AFC	A4	4D	1	

## SERVICE DATA LISTS

Service Group	No.	Name	Fix / Var	Description	Common		
					Slave Addr	Sub Addr	Fix Data
PIP	25	PSU2	Fix	For test	A4	4D	0
	26	PCVF	Fix	Internal 1H comb filter	A4	4D	0
	27	PBIT	Fix	Y clamp time constant	A4	4E	0
	28	PAFC	Fix	AFC time constant	A4	4E	0
	29	PACC	Fix	Color decoder amplitude	A4	4E	21
	30	PSDT	Fix	System automatic judgment	=	=	
	31	PBUR	Fix	VCXO mode selection	A4	4F	0
	32	PEVE	Fix	Main picture PAL-N	A4	4F	0
	33	PINW	Fix	Invert sub picture field definition	A4	4F	0
	34	PINR	Fix	Invert main picture field definition	A4	4F	0
	35	PVMD	Fix	Vertical display mode when pal-n	=	=	
	36	PREF	Fix	Main picture field fix	A4	4F	0
	37	PARE	Fix	Automatic 50/60 Hz judgement	A4	4F	0
	38	PBWD	Fix	BW det. Treshold setting	A4	50	1
	39	PFRA	Fix	Freq. Adjustment for free run mode	A4	51	0
	40	PPAL	Fix	Parameter setting for PAL-M judgment	A4	52	52
	41	PHPO	Fix	Sub picture h position	A4	58	3
	42	PVPO	Fix	Sub picture v position	A4	59	22
	43	PHTI	Fix	Display timing adjust	A4	44	3
	44	PHAJ	Fix	Main/Sub switch delay control	A4	47	2
	45	PBGY	Fix	Back ground Y level setting	A4	53	0
	46	PCRO	Fix	Sub picture read mode	A4	54	0
	47	PPAR	Fix	Thereshold contol for ident judgement of sub	A4	50	1
	48	PHPF	Fix	Y output HPF	A4	51	0
	49	PFSC	Fix	FSC output	A4	43	0
	50	PVCH	Fix	15h,16h,17h, setting mode	A4	4C	0
	51	PVON	Fix	V-chip decode mode	A4	53	1
	52	PVLN	Fix	V-chip data slicer line selection	A4	54	17
	53	PVSB	Fix	V-chip data slicer start bit detection parameter	A4	55	64
	54	PVLV	Fix	V-chip data slicer slice parameter	A4	56	130
	55	SUSW	Fix	Sub-Unlock bit position switch	A4	59	0

## SERVICE DATA LISTS

Service Group	No.	Name	Fix / Var	Description	KV-27FS100/27FS200/29FS100				KV-32FS100/32FS200/34FS100			
					Slave Addr	Sub Addr	Fix Data	Var Data	Slave Addr	Sub Addr	Fix Data	Var Data
AP	0	SBAL	Fix	Sub Balance	A8	41		4	A8	41		4
	1	SBAS	Fix	Sub Bass	A8	43		4	A8	43		4
	2	STRE	Fix	Sub Treble	A8	42		0	A8	42		0
	3	SRL	Fix	Surround level	A8	44		0	A8	44		0
	4	BBOH	Fix	Surround Off - BBE high	A8	45		10	A8	45		10
	5	BBOL	Fix	Surround Off - BBE low	A8	45		5	A8	45		5
	6	BBSH	Fix	Simulated - BBE high	A8	46		0	A8	46		0
	7	BBSL	Fix	Simulated - BBE low	A8	46		0	A8	46		0
	8	BBMH	Fix	Surround - BBE high	A8	47		0	A8	47		0
	9	BBML	Fix	Surround - BBE low	A8	47		0	A8	47		0
	10	BBGH	Fix	WOW - BBE high	A8	48		6	A8	48		6
	11	BBGL	Fix	WOW - BBE low	A8	48		9	A8	48		9
	12	BBTH	Fix	Trusurround - BBE high	A8	49		7	A8	49		7
	13	BBTL	Fix	Trusurround - BBE low	A8	49		8	A8	49		8
	14	VFIX	Fix	Audio output fix data	A8	4A		236	A8	4A		240
15	AGCL	Fix	AGC Level	A8	44		2	A8	44		2	

Service Group	No.	Name	Fix / Var	Description	Common		
					Slave Addr	Sub Addr	Fix Data
CCD	0	DUM0	Fix	Only for testing	=	=	
	1	VOSD	Fix	Only for testing	=	=	

Service Group	No.	Name	Fix / Var	Description	Common		
					Slave Addr	Sub Addr	Fix Data
OP	0	DISP	Fix	OSD Display position	A4	06	28
	1	RAMW	Fix		=	=	
	2	ICMP	Fix	Comparison data to determine Non-interlace signal for OSD	A4	39	4
	3	IPOR	Fix	0:Even, 1: Odd, Other: do not change	A4	3A	1
	4	FAWD	Fix	1: Forced to auto wide mode, 0:normal	A0	5D	0
	5	HCLW	Fix	H-Count Lower limit	A4	02	67
	6	HCHG	Fix	H-Count Higher limit	A4	03	254
	7	9VTM	Fix	Delay for 9V check subsystem	A4	04	55
8	ZDET	Fix	Zero detect relay delay	A4	05	123	

Service Group	No.	Name	Fix / Var	Description	Slave Addr	Sub Addr	Var Data
ID	0	ID0	Fix	Model variation ID0	A4	78	SEE ID MAP
	1	ID1	Fix	Model variation ID1	A4	79	SEE ID MAP
	2	ID2	Fix	Model variation ID2	A4	7A	SEE ID MAP
	3	ID3	Fix	Model variation ID3	A4	7B	SEE ID MAP
	4	ID4	Fix	Model variation ID4	A4	7C	SEE ID MAP
	5	ID5	Fix	Model variation ID5	A4	7D	SEE ID MAP
	6	ID6	Fix	Model variation ID6	A4	7E	SEE ID MAP
7	ID7	Fix	Model variation ID7	A4	7F	SEE ID MAP	

To determine ID's value, ID map must be referred

## 4-5. ID MAP TABLE

Model	Destination	ID-0	ID-1	ID-2	ID-3	ID-4	ID-5	ID-6	ID-7
KV-27FS100	US	89	31	73	98	14	0	0	16
KV-27FS100	CND	89	31	73	82	14	0	0	16
KV-27FS200	USA	89	31	73	98	14	0	6	16
KV29FS100	E	81	31	201	194	46	0	0	80
KV-32FS100	USA	89	31	73	98	14	0	0	16
KV-32FS100	CND	89	31	73	82	14	0	0	16
KV-32FS200	USA	89	31	73	98	14	0	6	16
KV-34FS100	E	81	31	201	194	46	0	0	80

## 4-6. A BOARD ADJUSTMENTS

### H. FREQUENCY (FREE RUN) CHECK

1. Input a TV mode (RF) with no signal.
2. Connect a frequency counter to base of Q501 (TP-25 H. DRIVE) on the A Board.
3. Check H. Frequency for  $15734 \pm 400/200$  Hz.

### V. FREQUENCY (FREE RUN) CHECK

1. Select video 1 with no signal input.
2. Set the conditions for a standard setting.
3. Connect the frequency counter to TP-27 (V OUT) or CN501 pin ⑥ (V DY+) and ground on the A Board .
4. Check that V. Frequency shows  $60 \pm 5$  Hz.

### SUBCONTRAST ADJUSTMENT (RDRV)

1. Input a color-bar signal and set the level to 75%.
2. Set in Standard mode.
3. Activate the Service Adjustment Mode. Set color min pic max.
4. Set GON and BON items. Using ③ and ⑥ set each to the following values. Leave RON set to "1".

Signal Type	Mode	Category	Display Item	Item Data
ntsc	service	video	rdrv	26
	vchp			00000000 00000000

R ON: ON (1)  
G ON: OFF (0)  
B ON: OFF (0)

5. Connect an oscilloscope probe to C Board, CN705 pin 3 (Red Out) (TP35).
6. Select SCON with ① and ④ .

7. Adjust the value of SCON with ③ and ⑥ for  $1.90 \pm 0.05V_{pp}$ .

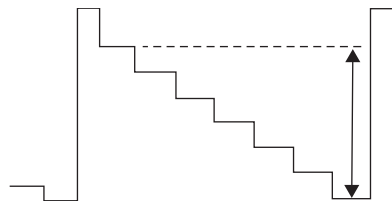

8. Reset GON and BON values to "1".  
R ON: ON (1)  
G ON: ON (1)  
B ON: ON (1)
9. Press [MUTING] then [ENTER] to save into the memory.
10. After adjusting SCON, if still out of spec, use RDRV register as a fine adjustment.

### DISPLAY POSITION ADJUSTMENT (DISP)

1. Input a color-bar signal.
2. Set to Service Adjustment Mode.
3. Select DISP with ① and ④ .
4. Adjust values of DISP with ③ and ⑥ to adjust characters to the center.
5. Write to memory by pressing [MUTING] then [ENTER] .
6. Check to see if the text is displayed on the screen.

Signal Type	Mode	Category	Display Item	Item Data
ntsc	service	micro	disp	48
	vchp			00000000 00000000

### SUB BRIGHT ADJUSTMENT (SBRT)

1. Input a monoscope signal.
2. Activate the Service Adjustment Mode.
3. Set the PICTURE and BRIGHTNESS to minimum.
4. Select the SBRT item with ① and ④ .
5. Adjust the values of SBRT with ③ and ⑥ to obtain a faintly visible crosshatch.
6. Press [MUTING] then [ENTER] to save into the memory.

### SUB HUE, SUB COLOR ADJUSTMENT (SHUE, SCOL)

1. Input color-bar signal at 75%.
2. Activate the Service Adjustment Mode.
3. Set (PIC) to Max and (COL) to 50%.
4. Connect an oscilloscope probe to C Board, CN705Pin ④ Blue Out.
5. Select the SHUE and SCOL item with ① and ④ .

- While showing the SHUE item, adjust the waveform with **1** and **4** until the second and third bars show the same level ( $V2 = V3 < 0.15V_{p-p}$ ).
- While showing the SCOL item, adjust the waveform with **3** and **6** until the first and fourth bars show the same level ( $V1 = V4 < 0.15V_{p-p}$ ).

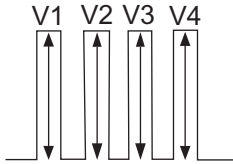

- Press **MUTING** then **ENTER** to save into the memory.

## V. SIZE ADJUSTMENT (VSIZ)

- Input a crosshatch signal.
- Activate the Service Adjustment Mode.
- Select the VSIZ item with **1** and **4**.
- Adjust value of VPOS with **1** and **4** for the best vertical center.
- Press **MUTING** then **ENTER** to save into the memory.

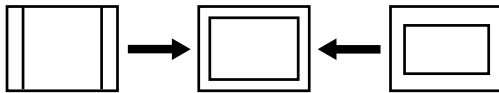

## V. CENTER ADJUSTMENT (VPOS)

Perform this adjustment after performing H. Frequency (Free Run) Check.

- Input a crosshatch signal.
- Activate the Service Adjustment Mode.
- Select the VPOS item with **1** and **4**.
- Adjust value of VPOS with **3** and **6** for the best vertical center.
- Press **MUTING** then **ENTER** to save into the memory.



## H. CENTER ADJUSTMENT (HPOS)

Perform this adjustment after performing H. Frequency (Free Run) Check.

- Input a crosshatch signal.
- Activate the Service Adjustment Mode.
- Select the HPOS item with **1** and **4**.
- Adjust the value of HPOS with **3** and **6** for the best horizontal center.
- Press **MUTING** then **ENTER** to save into the memory.

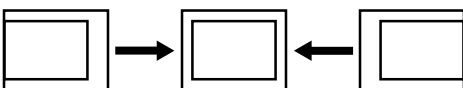

## H. SIZE ADJUSTMENT (HSIZ)

- Input a monoscope signal.
- Activate the Service Adjustment Mode.
- Select HSIZ with **1** and **4**.
- Adjust with **3** and **6** for the best horizontal size.
- Press **MUTING** then **ENTER** to save into the memory.

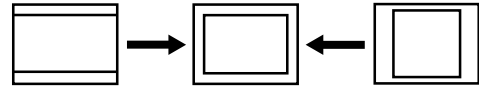

## V. LINEARITY (VLIN), V. CORRECTION (SCOR), PIN AMP (PAMP), AND HORIZONTAL TRAPEZOID (HTRP) ADJUSTMENTS

- Input a crosshatch signal.
- Activate the Service Adjustment Mode.
- Select VLIN, SCOR, PAMP, and HTRP with with **1** and **4**.
- Adjust with **3** and **6** for the best horizontal size.
- Press **MUTING** then **ENTER** to save into the memory.

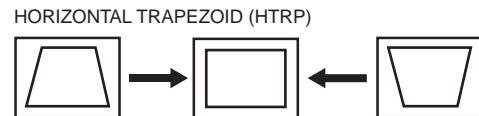
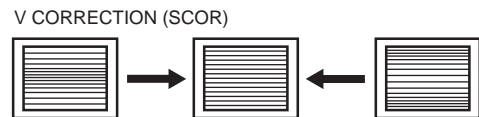
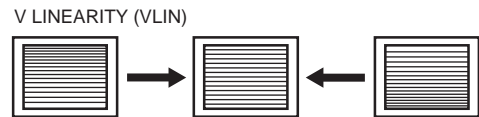

## V. ANGLE (VANG), V. BOW (VBOW), UPPER PIN (UPIN) AND LOW PIN (LPIN) ADJUSTMENTS

1. Input a crosshatch signal.
2. Activate the Service Adjustment Mode.
3. Select VANG, VBOW, UPIN, and LPIN with **[1]** and **[4]**.
4. Adjust with **[3]** and **[6]** for the best picture.
5. Press **[MUTING]** then **[ENTER]** to save into the memory.

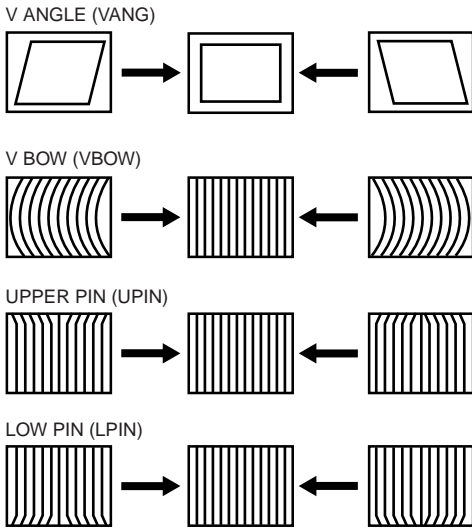

## SERVICE ADJUSTMENT MODE MEMORY

1. After completing all adjustments, press **[0]** then **[ENTER]**.

Read From Memory

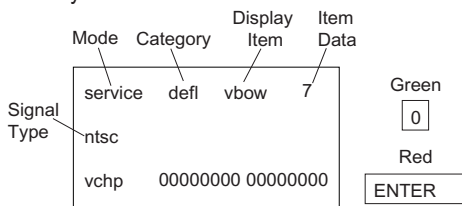



## SECTION 5: DIAGRAMS

### 5-1. CIRCUIT BOARDS LOCATION

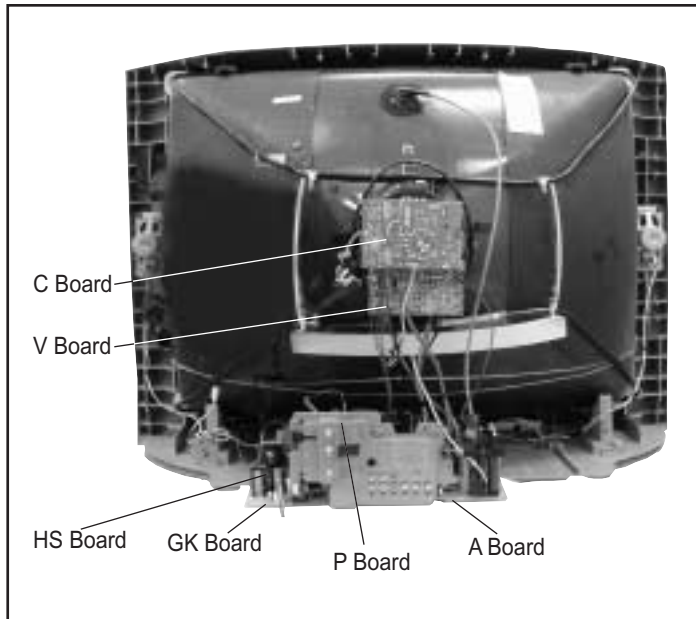

The components identified by shading and  $\triangle$  symbol are critical for safety. Replace only with part number specified.

The symbol  $\square$  indicates a fast operating fuse and is displayed on the component side of the board. Replace only with fuse of the same rating as marked.

Les composants identifiés par un trame et une marque  $\triangle$  sont critiques pour la sécurité. Ne les remplacer que par une pièce portant le numéro spécifié.

Le symbole  $\square$  indique une fusible à action rapide. Doit être remplacé par une fusible de même valeur, comme marqué.

### 5-2. PRINTED WIRING BOARDS AND SCHEMATIC DIAGRAMS INFORMATION

All capacitors are in  $\mu\text{F}$  unless otherwise noted.  $\text{pF}$  :  $\mu\text{pF}$  50V or less are not indicated except for electrolytics and tantalums.

All electrolytics are in 50V unless otherwise specified.

All resistors are in ohms.  $\text{k}\Omega=1000\Omega$ ,  $\text{M}\Omega=1000\text{k}\Omega$

Indication of resistance, which does not have one for rating electrical power, is as follows: Pitch : 5mm  
Rating electrical power :  $\frac{1}{4}\text{W}$

$\frac{1}{4}\text{W}$  in resistance,  $\frac{1}{10}\text{W}$  and  $\frac{1}{8}\text{W}$  in chip resistance.

$\square$ : nonflammable resistor

$\square$ : fusible resistor

$\triangle$ : internal component

$\square$ : panel designation and adjustment for repair

$\perp$ : earth ground

$\perp$ : earth-chassis

All variable and adjustable resistors have characteristic curve B, unless otherwise noted.

Readings are taken with a color-bar signal input.

Readings are taken with a  $10\text{M}\Omega$  digital multimeter.

Voltages are DC with respect to ground unless otherwise noted.

Voltage variations may be noted due to normal production tolerances.

All voltages are in V.

S : Measurement impossibility.

$\text{---}$  : B+line

$\text{---}$  : B-line (Actual measured value may be different).

$\Rightarrow$  : signal path (RF)

Circled numbers are waveform references.

The components identified by  $\square$  in this basic schematic diagram have been carefully factory-selected for each set in order to satisfy regulations regarding X-ray radiation. Should replacement be necessary, replace only with the value originally used.

When replacing components identified by  $\square$ , make the necessary adjustments as indicated. If the results do not meet the specified value, change the component identified by  $\square$  and repeat the adjustment until the specified value is achieved.

(Refer to R530 and R531 adjustment on page 16.)

When replacing the parts listed in the table below, it is important to perform the related adjustments.

Part Replaced ( $\square$ )	Adjustment ( $\square$ )
<b>A BOARD:</b> R550, T503, T504, D519, IC501, R533, D521, R532, D520, C531, R529, R530, R531, C532	<b>HV HOLD DOWN</b> R530, R531

### REFERENCE INFORMATION

#### RESISTOR

: RN METAL FILM

: RC SOLID

: RPRD NONFLAMMABLE CARBON

: FUSE NONFLAMMABLE FUSIBLE

: RW NONFLAMMABLE WIREWOUND

: RS NONFLAMMABLE METAL OXIDE

: RB NONFLAMMABLE CEMENT

:  $\otimes$  ADJUSTMENT RESISTOR

#### COIL

: LF-8L MICRO INDUCTOR

#### CAPACITOR

: TA TANTALUM

: PS STYROL

: PP POLYPROPYLENE

: PT MYLAR

: MPS METALIZED POLYESTER

: MPP METALIZED POLYPROPYLENE

: ALB BIPOLAR

: ALT HIGH TEMPERATURE

: ALR HIGH RIPPLE

5-3. BLOCK DIAGRAM AND SCHEMATICS

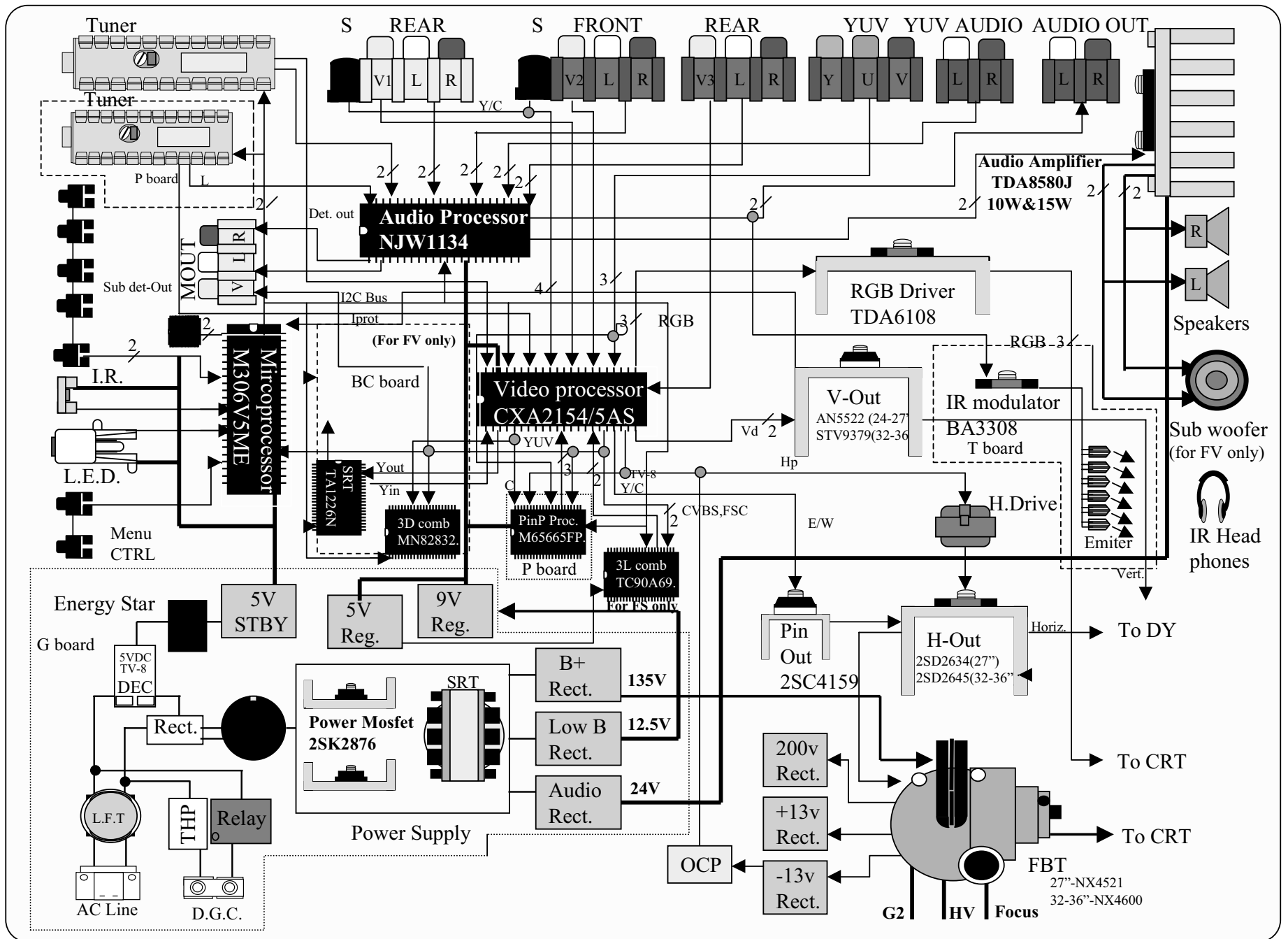

A BOARD SCHEMATIC DIAGRAM

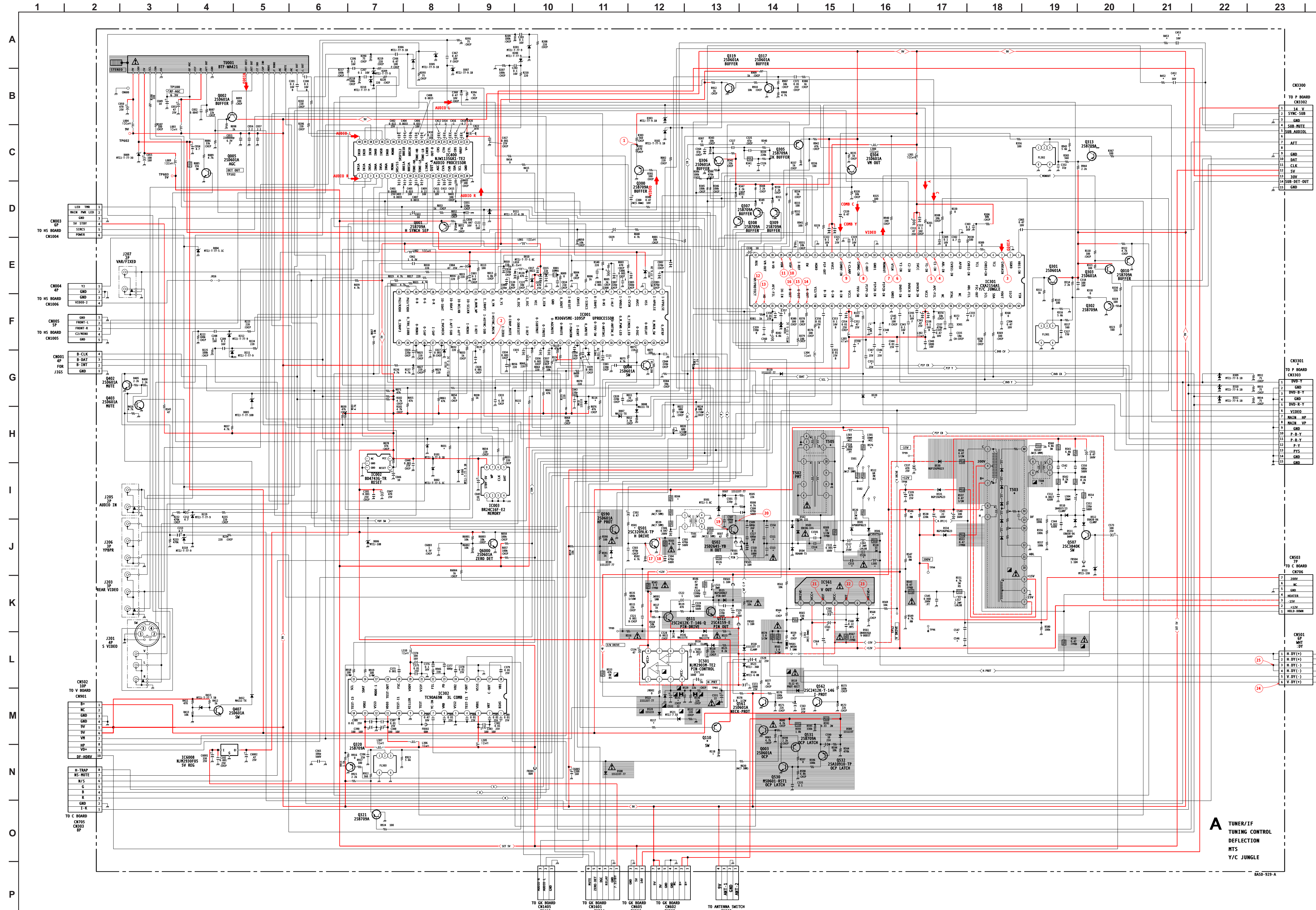

**A** TUNER/IF  
TUNING CONTROL  
DEFLECTION  
MTS  
Y/C JUNGLE



A

[TUNING CONTROL, DEFLECTION, TUNER/IF, Y/C JUNGLE, MTS]

1 2 3 4 5 6 7 8 9 10 11 12

A

B

C

D

E

F

G

H

I

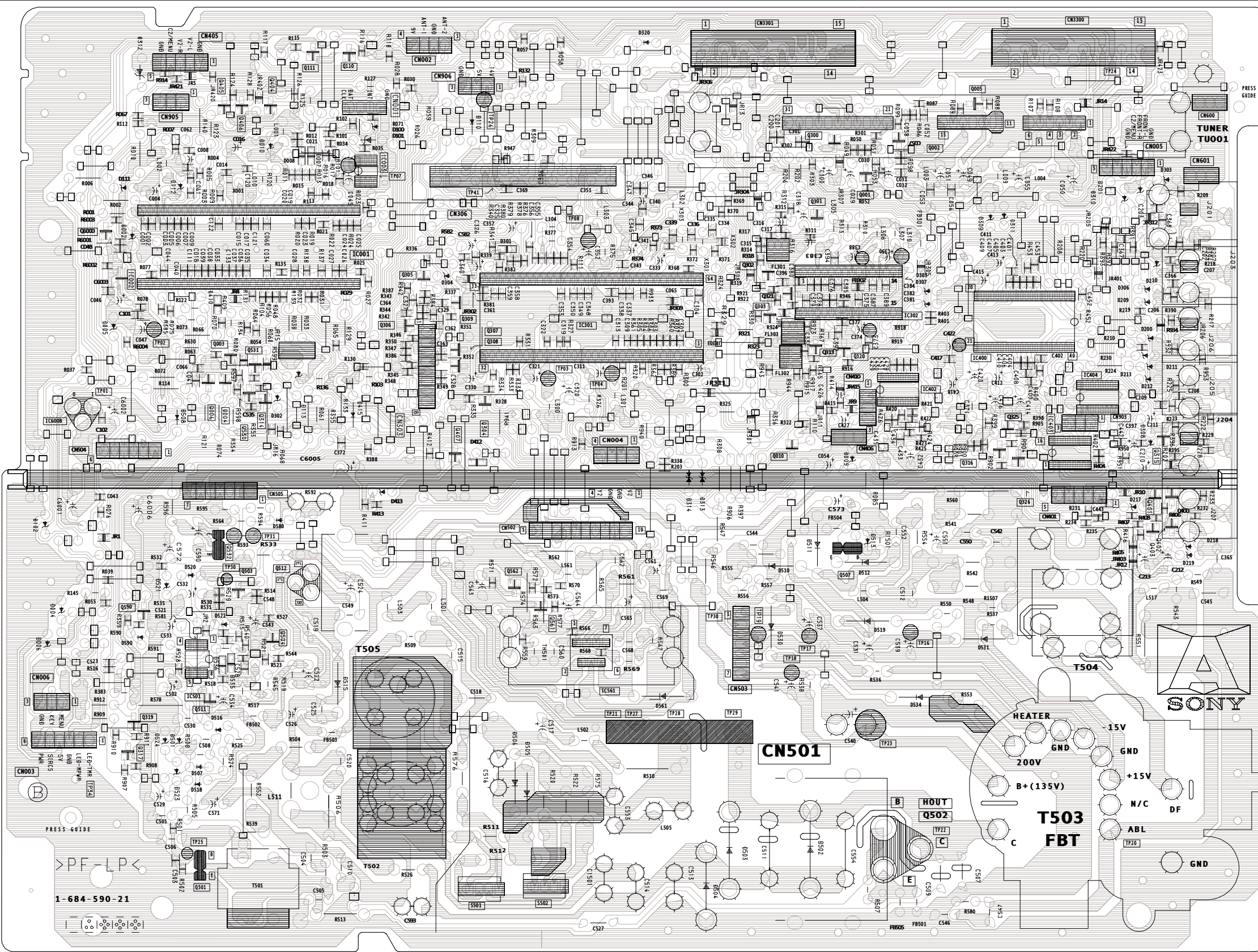

**A BOARD LOCATOR LIST**

DIODE		D503	H-7	TRANSISTOR	
D002	C-2	D504	I-7	Q001	B-8
D004	F-1	D505	H-5	Q002	B-9
D005	D-2	D506	H-5	Q003	D-3
D006	F-1	D507	H-2	Q004	D-3
D007	B-4	D508	D-2	Q005	A-10
D008	B-3	D510	F-8	Q010	E-8
D009	E-8	D511	F-8	Q110	A-4
D010	B-3	D512	F-9	Q300	B-8
D102	C-2	D513	F-9	Q301	B-8
D110	B-5	D515	G-4	Q302	C-7
D111	B-2	D516	G-3	Q303	D-7
D112	B-2	D518	H-2	Q304	D-5
D113	D-3	D519	F-9	Q305	C-4
D200	D-11	D520	F-2	Q306	D-4
D201	B-11	D521	F-2	Q307	C-5
D209	C-11	D522	F-3	Q308	D-5
D210	C-11	D523	H-2	Q309	C-5
D211	D-11	D524	G-2	Q313	D-8
D212	D-11	D530	F-8	Q317	G-2
D218	F-12	D531	F-10	Q319	G-2
D219	F-12	D534	G-9	Q320	D-8
D303	B-11	D535	G-3	Q321	C-7
D304	C-5	D536	G-3	Q402	E-12
D305	C-9	D561	G-7	Q403	E-11
D306	C-11	D580	E-3	Q407	E-5
D307	C-9	D590	F-2	Q501	H-2
D309	B-10	<b>IC</b>		Q502	H-9
D310	B-11	IC001	C-3	Q507	F-8
D311	B-10	IC002	C-2	Q511	G-3
D320	A-7	IC003	B-4	Q512	F-3
D410	C-2	IC301	C-6	Q530	D-3
D412	E-5	IC302	C-9	Q531	D-3
D413	E-4	IC400	D-10	Q532	F-3
D415	D-4	IC501	G-2	Q561	F-6
D501	G-2	IC561	G-6	Q562	F-5
D502	H-8	IC6008	D-1	Q590	F-2
				Q6000	C-1

## A BOARD WAVEFORMS

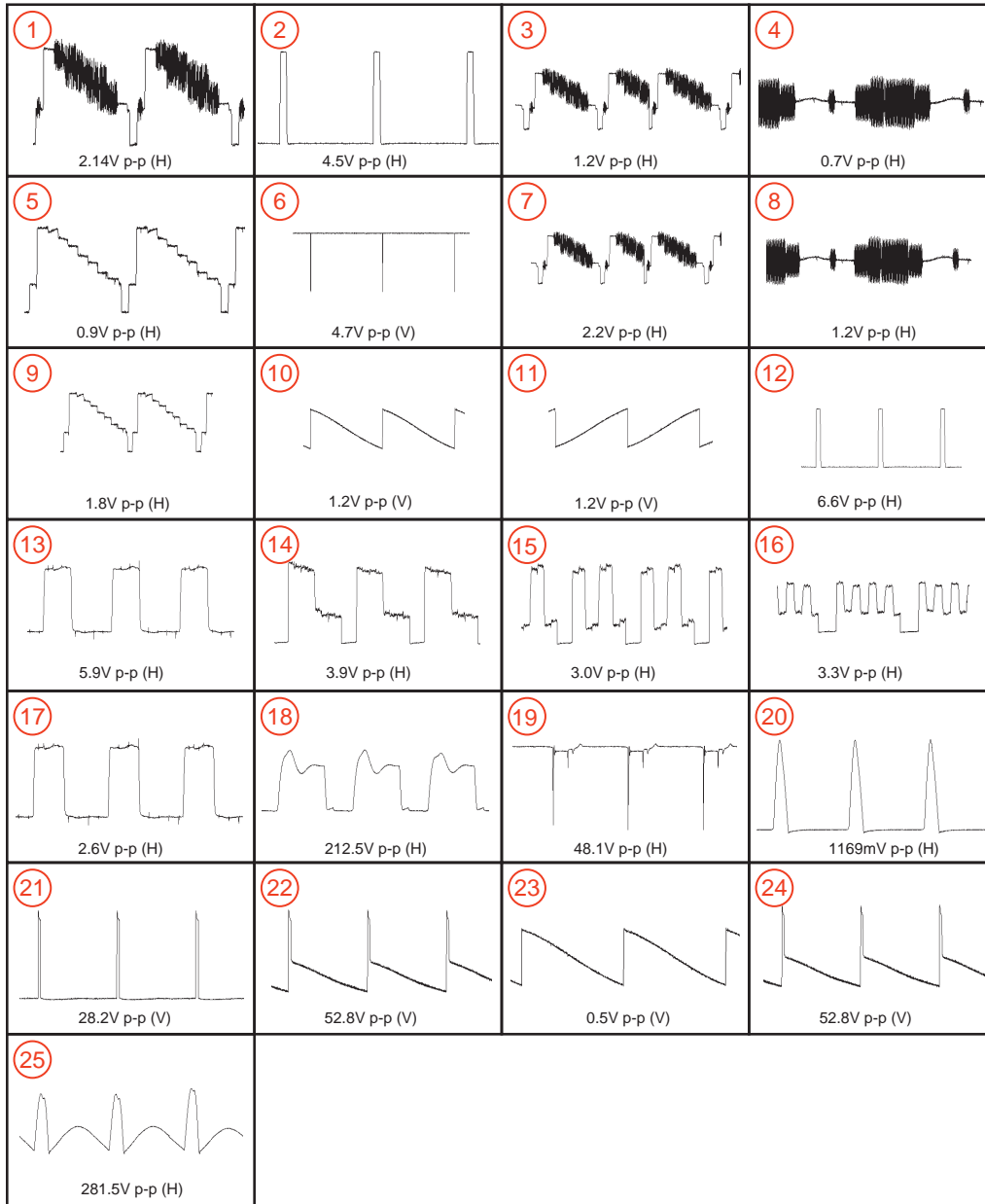

## A BOARD MARK(\*) LIST

REF. NO.	LOCATION	KV-27FS100	KV-27FS200	KV-29FS100N KV-29FS100S	KV-32FS200	KV-32FS100 KV-34FS100N KV-34FS100S
C035	F-9	#	0.001UF	#	0.001UF	#
C111	F-11	#	220PF	#	220PF	#
C326	C-14	0.033UF	0.033UF	0.033UF	0.0047UF	0.033UF
C346	F-16	#	0.01UF 25V	#	0.01UF 25V	#
C347	F-16	#	0.01UF 25V	#	0.01UF 25V	#
C348	F-16	0.01UF 25V	#	0.01UF 25V	#	0.01UF 25V
C349	F-16	0.01UF 25V	#	0.01UF 25V	#	0.01UF 25V
C350	F-15	0.01UF 25V	#	0.01UF 25V	#	0.01UF 25V
C351	F-15	#	0.01UF 25V	#	0.01UF 25V	#
C452	A-21	#	0.01UF 16V	#	0.1UF 16V	#
C453	A-21	#	0.01UF 16V	#	0.1UF 16V	#
C511	I-14	17000PF 1.2KV	17000PF 1.2K	17000PF 1.2KV	22000PF 1.2KV	22000PF 1.2KV
C513	J-14	0.047UF 630V	0.047UF 630V	0.047UF 630V	0.051UF 400V	0.051UF 400V
C514	I-15	0.68UF 250V	0.68UF 250V	0.68UF 250V	0.82UF 250V	0.82UF 250V
C516	J-15	1UF 250V	1UF 250V	1UF 250V	0.82UF 250V	0.82UF 250V
C542	H-19	#	#	#	220PF 500V	220PF 500V
C546	K-16	#	#	#	0.001UF 100V	0.001UF 100V
C547	K-16	#	#	#	0.001UF 100V	0.001UF 100V
C553	J-15	0.1UF 250V	0.1UF 250V	0.1UF 250V	0.47UF 250V	0.47UF 250V
C554	I-14	2700PF 1.2KV	2700PF 1.2KV	2700PF 1.2KV	4700PF 1.2KV	4700PF 1.2KV
C1501	I-15	#	#	#	0.1UF 250V	0.1UF 250V
CN002	P-13	#	4P	#	4P	#
CN3300	C-23	#	15P	#	15P	#
CN3301	G-23	#	15P	#	15P	#
D320	G-16	#	1SS133T-77	#	1SS133T-77	#
IC561	J-15	TDA8172	TDA8172	TDA8172	STV9379	STV9379
L505	J-16	150UH	150UH	150UH	68UH	68UH
Q110	M-13	#	2SB709A-QRS-TX	#	2SB709A-QRS-TX	#
R031	H-8	#	100	#	100	#
R114	G-11	#	220	#	220	#
R117	M-12	#	22K	#	22K	#
R118	M-13	#	22K	#	22K	#
R131	F-9	#	220	#	220	#
R132	G-9	#	4.7K	#	4.7K	#
R139	F-9	#	220	#	220	#
R329	D-14	#	100	#	100	#
R340	C-14	2.2M	2.2M	2.2M	3.3M	3.3M
R341	C-13	56K	56K	56K	330K	330K
R452	A-21	#	220	#	220	#
R453	A-21	#	220	#	220	#
R501	I-11	330	330	330	470	470
R504	I-12	68 2W	68 2W	68 2W	560 2W	560 2W
R516	K-11	8.2K	8.2K	8.2K	5.6K	5.6K
R523	K-13	22K	22K	22K	12K	12K
R526	J-13	4.7 2W	4.7 2W	4.7 2W	10 3W	10 3W
R531	L-13	180K 1/16W	180K	180K 1/16W	56K	56K
R546	I-17	33K	33K	33K	22K	22K
R554	I-20	15K 1W	15K 1W	15K 1W	2.2K 2W	2.2K 2W
R566	K-14	6.8K	6.8K	6.8K	5.6K	5.6K
R568	K-16	6.8K	6.8K	6.8K	5.6K	5.6K
R576	H-16	22 3W	22 3W	22 3W	10 3W	10 3W
T503	I-18	8-598-834-20	8-598-834-20	8-598-834-20	8-598-824-10	8-598-824-10
T504	H-19	1-433-533-11	1-433-533-11	1-433-533-11	1-424-584-11	1-424-584-11
T505	H-15	1-431-693-11	1-431-693-11	1-431-693-11	1-435-098-11	1-435-098-11

#: NOT MOUNTED



## A BOARD IC VOLTAGE LIST

<b>IC001</b>		37	0.0	2	GND	30	5.9	2	3.1	10	4.5	6	GND
<b>PIN</b>	<b>VOLT</b>	38	4.2	3	GND	31	5.5	3	4.9	11	4.5	7	0.0
1	4.9	39	1.7	4	GND	32	7.6	4	2.4	12	4.5	8	GND
2	0.6	40	2.6	5	5.0	33	3.6	5	GND	13	4.5	9	9.0
3	GND	41	5.0	6	5.0	34	2.8	6	1.7	14	4.5	10	9.0
4	5.0	42	5.0	7	0.0	35	2.5	7	2.6	15	0.6	11	9.0
5	0.2	43	0.2	8	5.0	36	3.9	8	GND	16	1.7	12	4.5
6	1.7	44	0.6	<b>IC301</b>		37	1.5	9	GND	17	1.7	13	4.5
7	1.4	45	1.2	<b>PIN</b>	<b>VOLT</b>	38	1.6	10	GND	18	4.7	14	4.5
8	0.5	46	4.8	1	5.0	39	1.5	11	4.9	19	4.7	15	4.5
9	N/C	47	N/C	2	GND	40	0.0	12	GND	20	GND	16	9.0
10	5.0	48	0.0	3	5.0	41	4.6	13	4.9	21	9.0	<b>IC501</b>	
11	GND	49	0.1	4	N/C	42	4.6	14	GND	22	4.4	<b>PIN</b>	<b>VOLT</b>
12	5.0	50	4.4	5	4.8	43	4.6	15	4.8	23	3.8	1	-13.3
13	2.3	51	5.0	6	5.0	44	9.0	16	4.7	24	3.8	2	8.2
14	GND	52	0.1	7	4.8	45	0.1	17	N/C	25	4.0	3	7.2
15	2.1	53	0.0	8	3.4	46	4.3	18	N/C	26	0.6	4	-15.0
16	5.0	54	4.8	9	5.2	47	5.2	19	2.4	27	4.6	5	2.3
17	2.6	55	0.1	10	1.9	48	5.2	20	4.9	28	4.6	6	2.5
18	2.6	56	0.0	11	0.0	49	GND	21	GND	29	4.6	7	-13.5
19	0.3	57	4.8	12	4.8	50	4.8	22	2.8	30	4.6	8	12.0
20	0.0	58	N/C	13	9.0	51	5.2	23	2.8	31	4.6	<b>IC561</b>	
21	2.1	59	N/C	14	0.0	52	5.2	24	3.3	32	4.6	<b>PIN</b>	<b>VOLT</b>
22	N/C	60	0.0	15	N/C	53	9.1	25	4.1	33	4.6	1	1.5
23	5.0	61	0.1	16	4.9	54	5.3	26	GND	34	N/C	2	12.0
24	5.0	62	4.6	17	4.4	55	N/C	27	3.6	35	4.5	3	-12.0
25	5.0	63	N/C	18	GND	56	1.7	28	1.6	36	4.5	4	-15.0
26	5.0	64	N/C	19	N/C	57	N/C	<b>IC400</b>		37	4.5	5	0.3
27	5.0	<b>IC002</b>		20	5.5	58	6.9	<b>PIN</b>	<b>VOLT</b>	38	4.5	6	14.2
28	0.0	<b>PIN</b>	<b>VOLT</b>	21	3.6	59	N/C	1	4.5	39	4.5	7	1.4
29	0.0	1	N/C	22	5.8	60	4.7	2	4.5	40	4.5	<b>IC6008</b>	
30	0.0	2	GND	23	9.0	61	4.7	3	4.5	<b>IC404</b>		<b>PIN</b>	<b>VOLT</b>
31	N/C	3	GND	24	4.4	62	4.7	4	4.5	<b>PIN</b>	<b>VOLT</b>	I	7.5
32	N/C	4	5.0	25	GND	63	1.1	5	4.5	1	4.5	O	5.0
33	N/C	5	5.0	26	4.1	64	5.1	6	4.5	2	GND	G	GND
34	N/C	<b>IC003</b>		27	2.4	<b>IC302</b>		7	N/C	3	0.4	All voltages are in V.	
35	0.0	<b>PIN</b>	<b>VOLT</b>	28	3.5	<b>PIN</b>	<b>VOLT</b>	8	4.5	4	0.4		
36	0.0	1	GND	29	3.5	1	1.3	9	4.5	5	4.5		



## A BOARD TRANSISTOR VOLTAGE LIST

	B	C	E		B	C	E
Q001	0.0	0.4	5.0	Q319	0.6	0.6	GND
Q002	4.4	9.0	3.8	Q320	4.8	GND	5.4
Q003	0.7	0.0	GND	Q321	3.6	GND	4.3
Q004	0.0	4.3	GND	Q402	0.0	0.0	GND
Q005	0.1	4.9	GND	Q403	0.0	0.0	GND
Q010	4.3	GND	4.9	Q407	0.7	0.0	GND
Q110	4.8	0.0	5.0	Q501	0.0	123.6	GND
Q300	4.6	GND	5.2	Q502	0.0	131.8	GND
Q301	3.1	9.0	2.4	Q507	0.3	110.7	GND
Q302	2.7	GND	3.2	Q511	-13.5	-8.4	-15.0
Q303	5.0	9.0	4.4	Q512	-14.9	-2.0	-15.0
Q304	5.0	9.0	4.4	Q530	0.0	4.4	GND
Q305	5.0	0.0	3.4	Q531	4.4	0.0	4.4
Q306	2.0	9.0	2.3	Q532	133.6	0.0	133.8
Q307	1.5	GND	2.2	Q561	0.0	4.4	GND
Q308	1.5	GND	2.2	Q562	0.0	0.0	GND
Q309	1.5	GND	2.2	Q590	0.0	3.6	GND
Q313	4.1	GND	4.7	Q6000	0.6	1.2	GND
Q317	0.0	3.9	GND				

All voltages are in V.

## IC001 BLOCK DIAGRAM

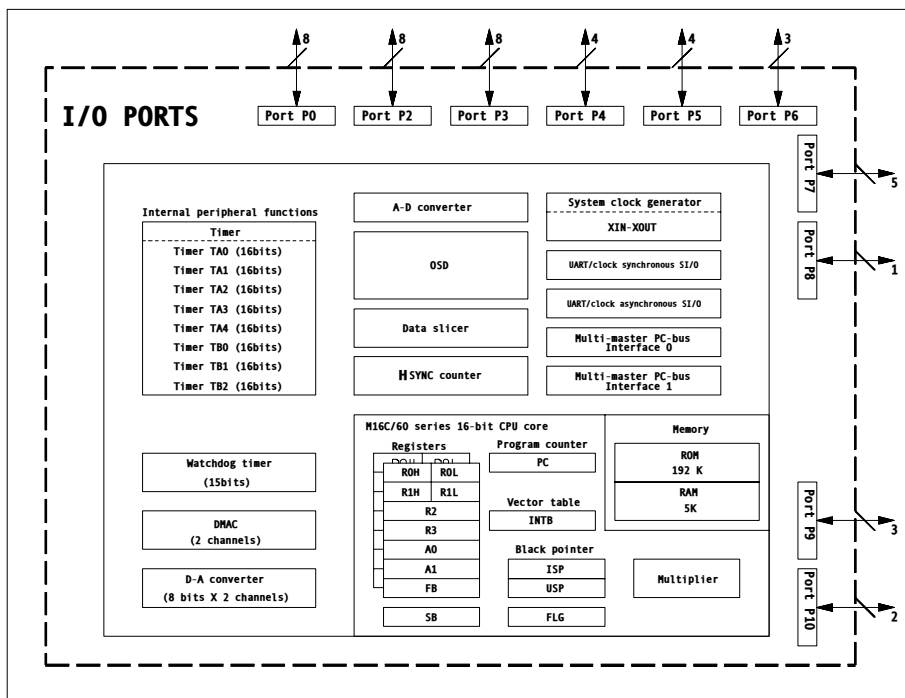

P BOARD SCHEMATIC DIAGRAM

P BOARD IC VOLTAGE LIST

IC3301		11	GND	23	GND	35	0.8
PIN	VOLT	12	GND	24	0.9	36	0.8
1	0.2	13	3.3	25	3.3	37	2.3
2	GND	14	3.2	26	3.5	38	0.8
3	4.5	15	N/C	27	2.0	39	0.8
4	4.5	16	3.3	28	1.7	40	GND
5	3.3	17	1.0	29	GND	41	0.8
6	GND	18	1.0	30	GND	42	0.6
7	N/C	19	0.5	31	GND	<b>IC3390</b>	
8	GND	20	0.5	32	0.6	<b>PIN</b>	<b>VOLT</b>
9	N/C	21	1.6	33	0.0	I	14.0
10	GND	22	1.0	34	3.3	O	9.0
						G	GND

All voltages are in V.

P BOARD TRANSISTOR TABLE

	B	C	E
Q151	8.4	4.5	9.0
Q152	3.9	9.0	3.2
Q3300	2.3	5.0	1.7
Q3301	1.4	5.0	0.8
Q3302	1.4	5.0	0.8
Q3304	3.9	9.0	3.3
Q3305	0.7	0.1	GND
Q3307	0.8	GND	1.5
Q3308	0.7	GND	1.4
Q3309	0.6	GND	1.3
Q3310	0.5	0.6	GND
Q3312	0.2	2.7	GND

All voltages are in V.

P BOARD WAVEFORM

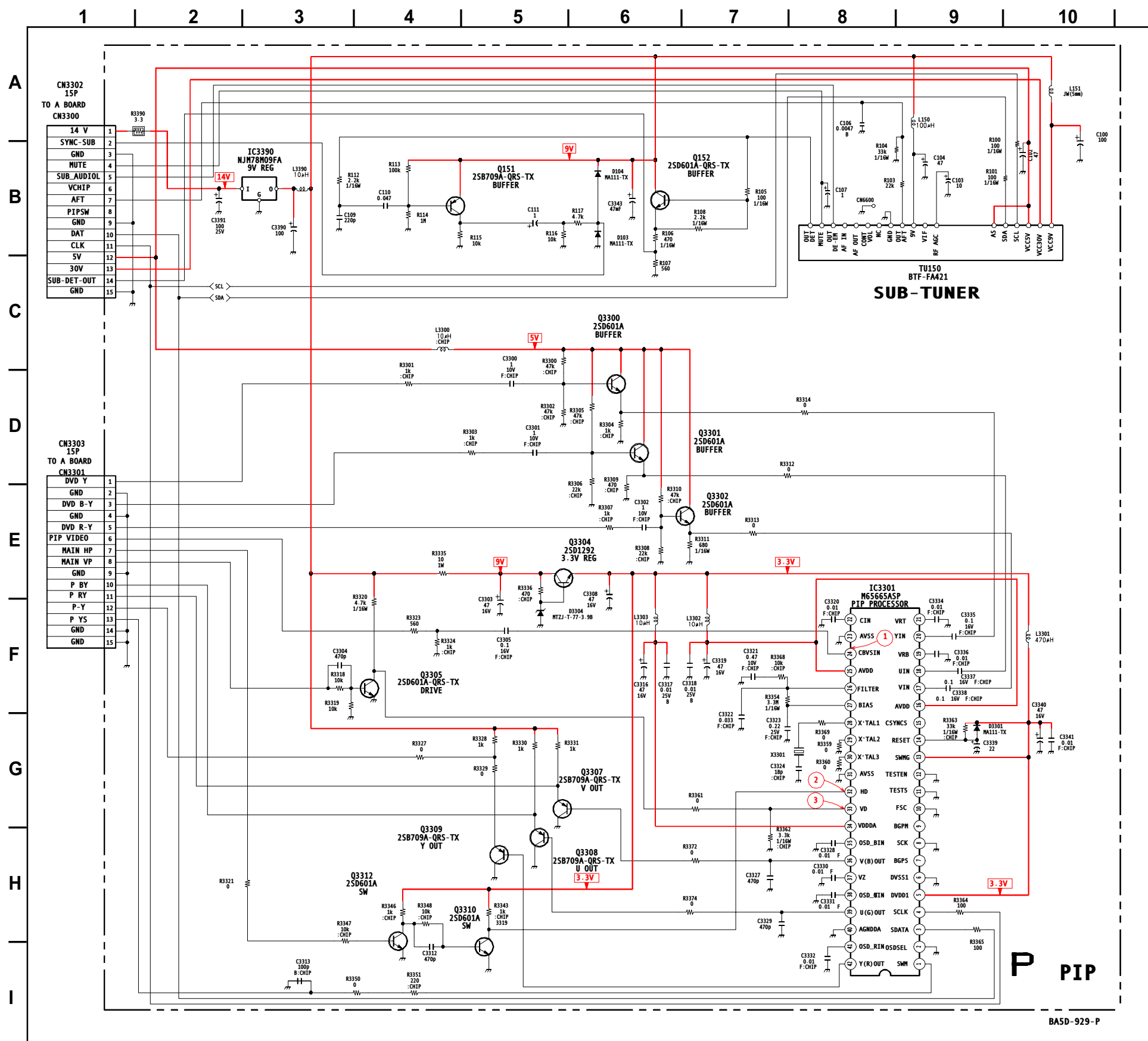
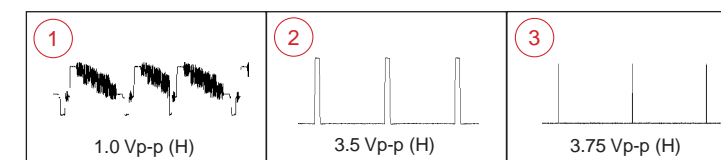

P

[PIP]

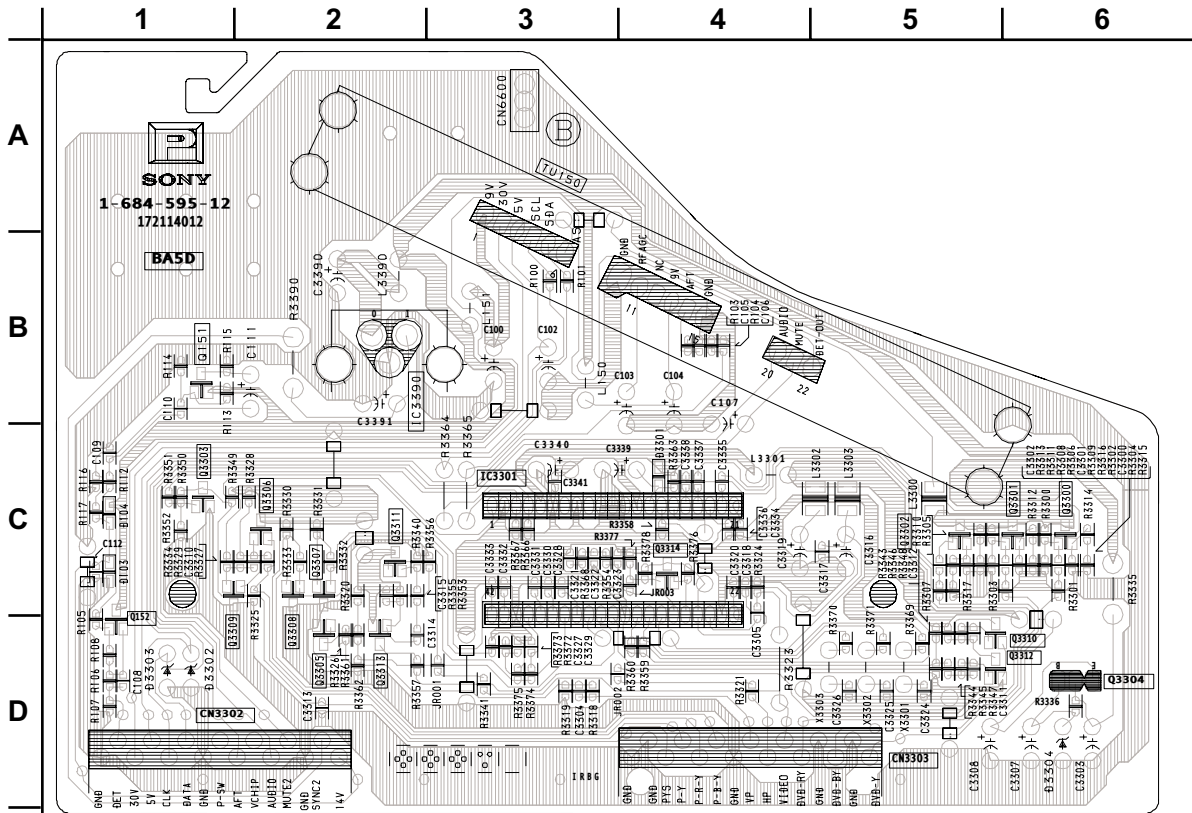

# HS BOARD SCHEMATIC DIAGRAM

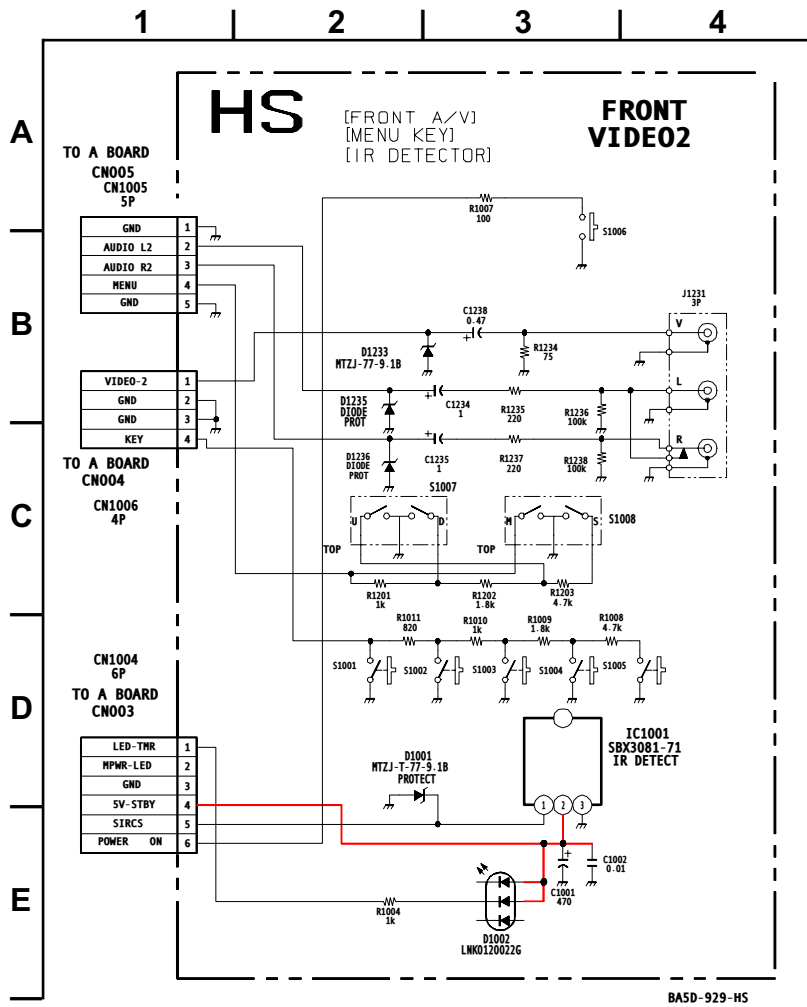

## HS BOARD IC VOLTAGE TABLE

IC1001	
PIN	VOLT
1	5.0
2	5.0
3	GND

All voltages are in V.

## HS [SIRCS, LEDS, MAIN POWER BUTTON]

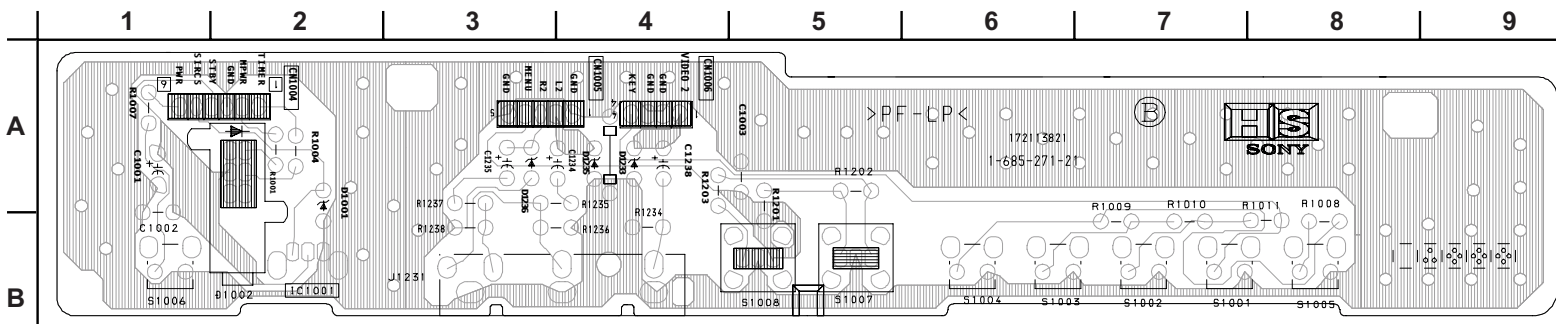

# C BOARD SCHEMATIC DIAGRAM

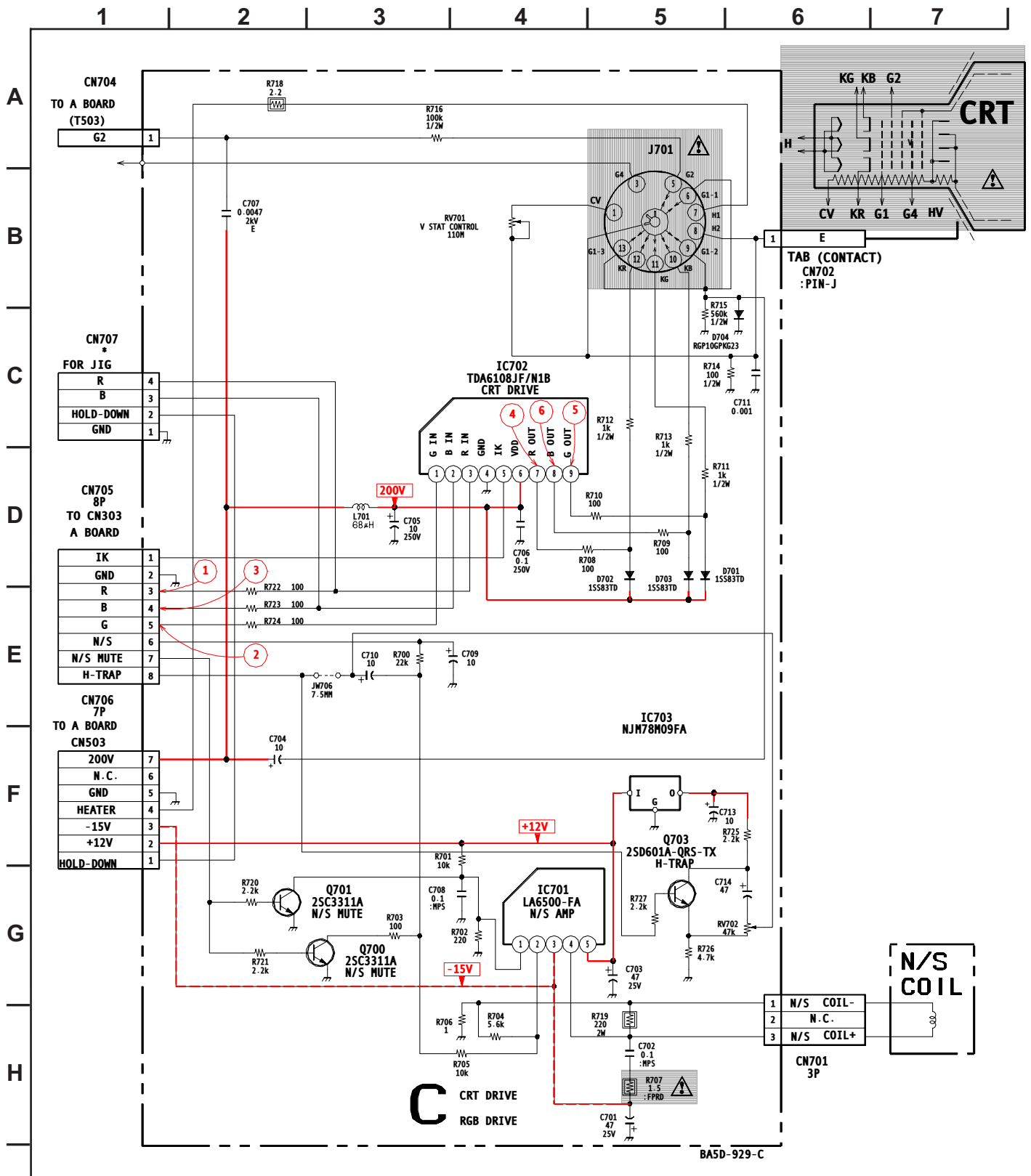

BA5D-929-C

**C**

[RGB DRIVE, CRT DRIVE]

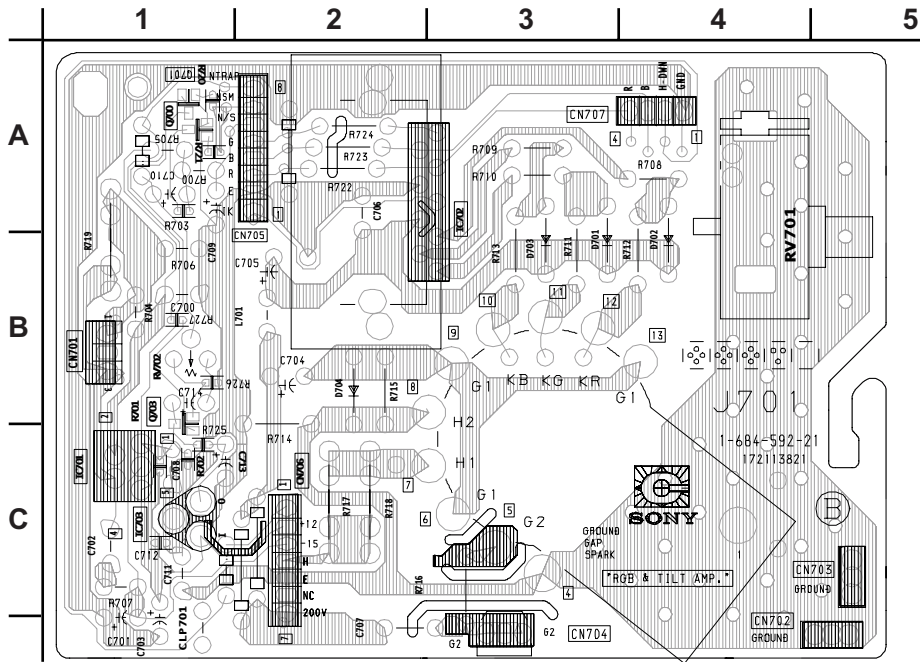

**C BOARD IC VOLTAGE TABLE**

IC701	
PIN	VOLT
1	0.3
2	0.3
3	-13.0
4	0.5
5	12.0
IC702	
PIN	VOLT
1	2.2
2	2.2
3	2.2
4	GND
5	5.0
6	200.0
7	139.7
8	142.0
9	138.6

All voltages are in V.

**C BOARD WAVEFORM**

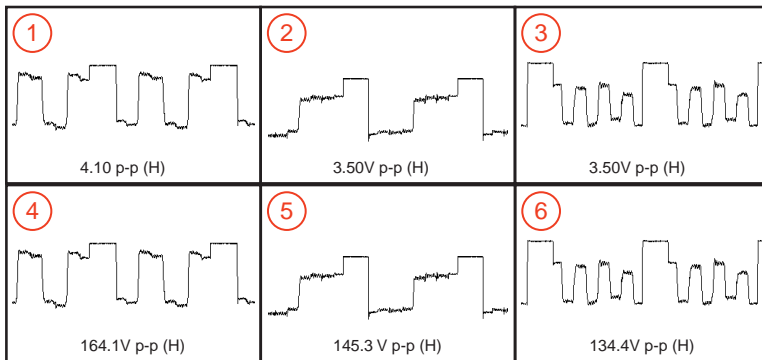

**C BOARD TRANSISTOR TABLE**

	B	C	E
Q700	0.3	0.8	GND
Q701	0.3	0.3	GND

All voltages are in V.

V BOARD SCHEMATIC DIAGRAM

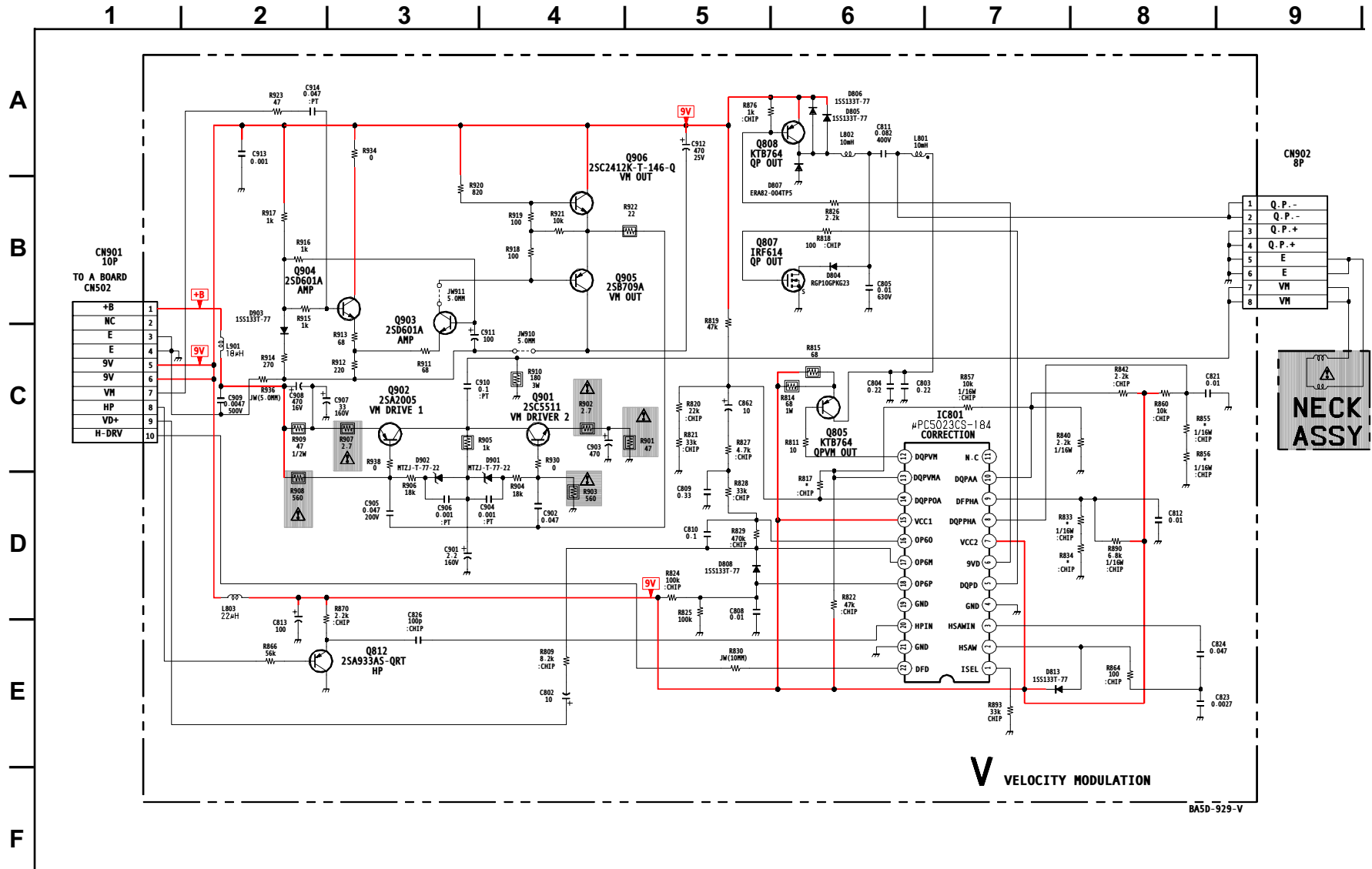



[VELOCITY MODULATION]

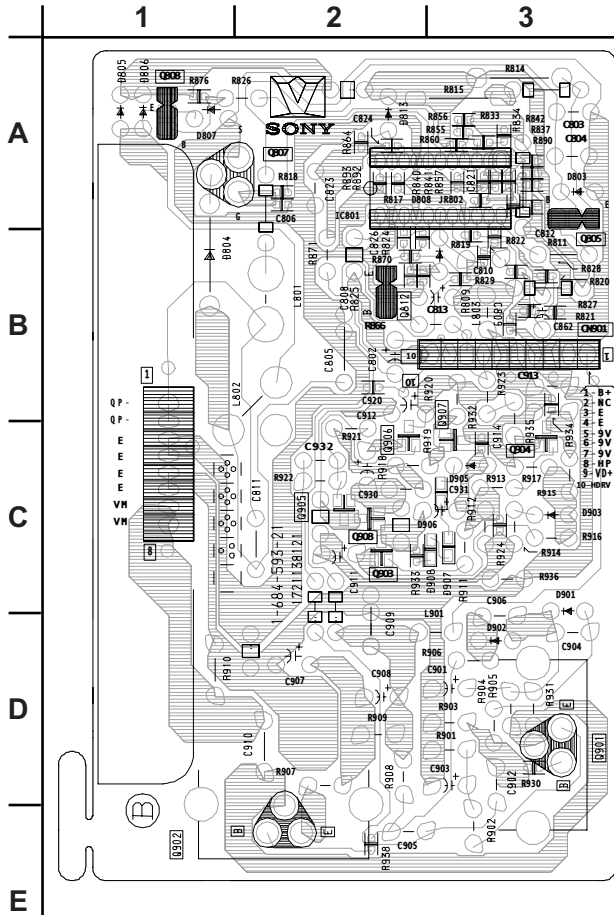

### V BOARD IC VOLTAGE LIST

IC801		11	N/C
PIN	VOLT		
1	7.4	12	3.5
2	2.3	13	3.8
3	4.8	14	4.5
4	4.8	15	9.0
5	GND	16	4.6
6	6.3	17	4.6
7	4.5	18	4.5
8	9.0	19	N/C
9	5.8	20	4.8
10	4.6	21	GND
	4.8	22	0.3

All voltages are in V.

### V BOARD TRANSISTOR TABLE

	B	C	E
Q805	3.5	1.8	4.2
Q808	8.6	4.3	9.0
Q812	1.3	GND	2.0
Q901	1.4	67.0	0.8
Q902	132.9	67.0	133.4
Q903	1.2	6.2	1.8
Q904	1.2	8.8	1.8
Q905	7.1	0.0	6.7
Q906	7.4	9.0	7.1
Q907	7.4	9.0	8.1
Q908	6.9	0.0	6.2

	D	G	S
Q807	9.5	6.3	GND

All voltages are in V.



# GK BOARD SCHEMATIC DIAGRAM

KV-27FS100/27FS200/29FS100/  
32FS100/32FS200/34FS100

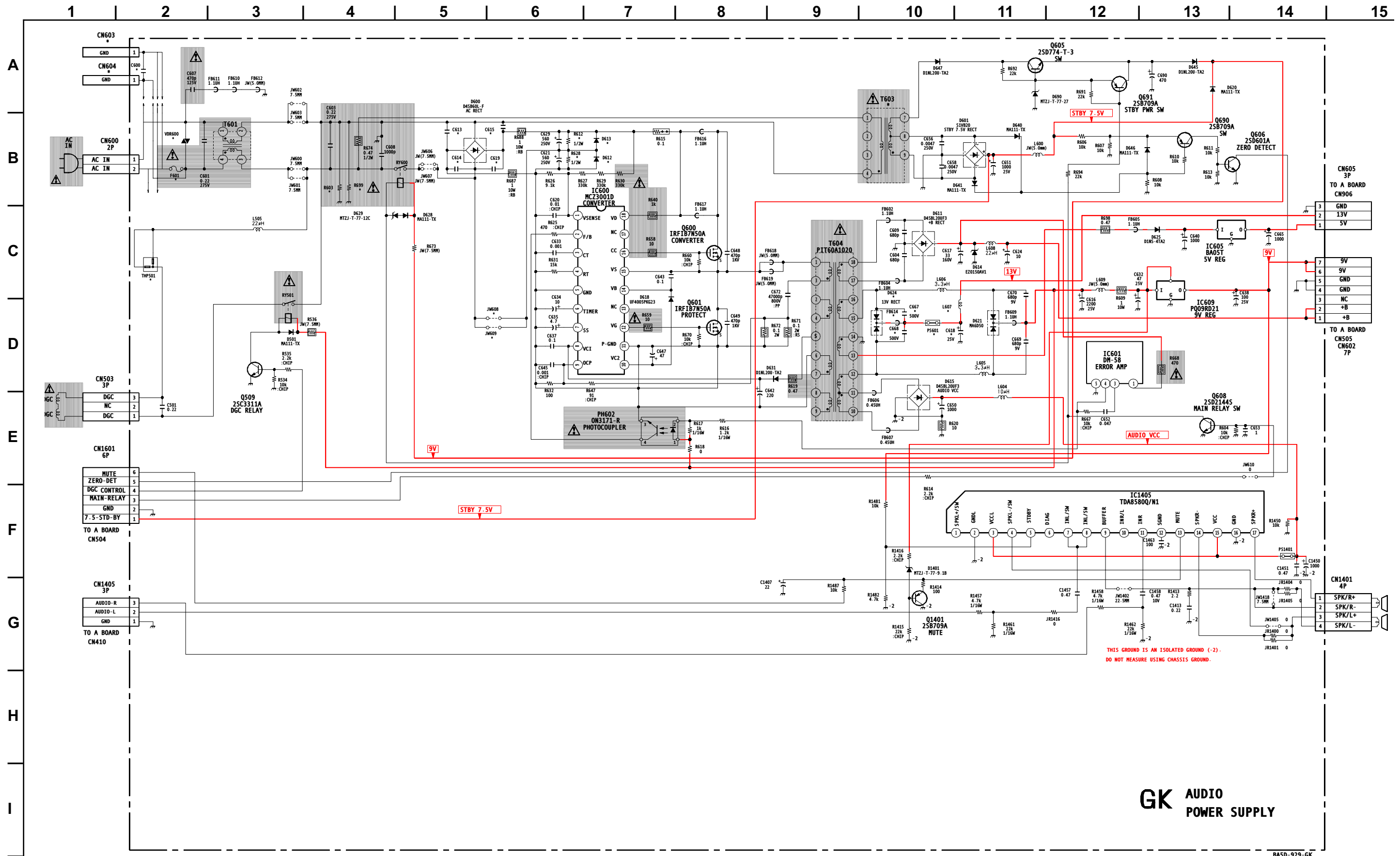

THIS GROUND IS AN ISOLATED GROUND (-).  
DO NOT MEASURE USING CHASSIS GROUND.

**GK AUDIO**  
POWER SUPPLY

BASD-929-GK

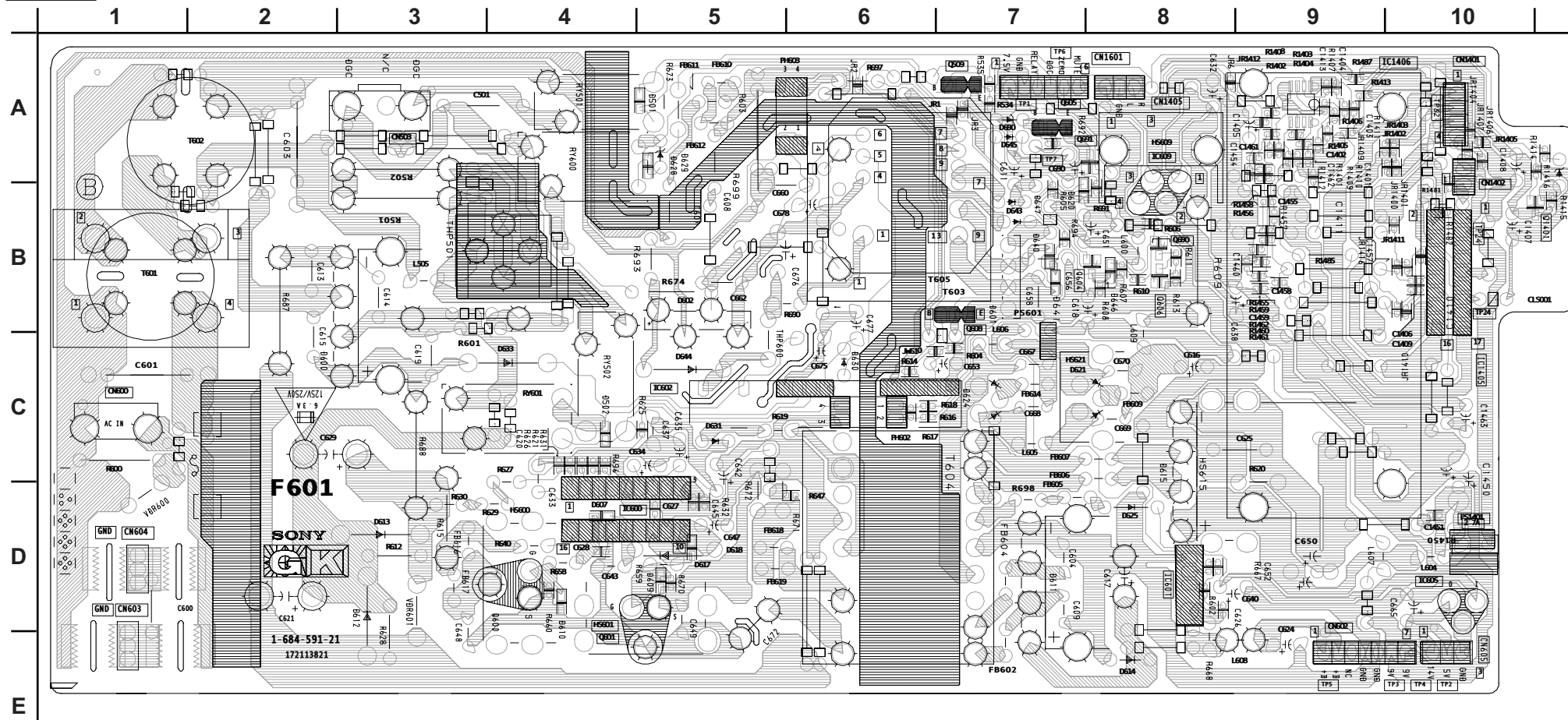

**GK BOARD LOCATOR LIST**

DIODE		IC	
D1401	A-11	IC1405	C-10
D501	A-5	IC1406	A-10
D600	C-2	IC600	D-5
D601	C-7	IC601	D-8
D611	D-7	IC602	C-5
D612	D-3	IC605	D-10
D613	D-3	IC609	A-8
D614	E-8	<b>TRANSISTOR</b>	
D615	C-8	Q1401	B-11
D618	D-5	Q509	A-7
D620	B-7	Q600	D-4
D621	C-8	Q601	E-4
D624	C-7	Q605	A-7
D625	D-8	Q606	B-8
D628	A-5	Q608	C-7
D629	A-5	Q690	B-8
D631	C-5	Q691	A-8
D640	B-7		
D641	C-7		
D645	A-7		
D646	C-8		
D647	B-7		
D690	A-7		

**GK BOARD MARK(\*) LIST**

REF. NO.	LOCATION	KV-27FS100 KV-29FS100N KV-32FS100 KV-34FS100N	KV-27FS200 KV-32FS200	KV-29FS100S	KV-34FS100S
C600	A-2	#	#	0.0047UF 250V	0.0047UF 250V
C613	B-5	#	#	0.001UF 2KV	0.001UF 2KV
C614	B-5	#	#	0.001UF 2KV	0.001UF 2KV
C615	B-6	#	#	0.001UF 2KV	0.001UF 2KV
C618	D-10	#	2200UF 25V	#	#
C619	B-6	#	#	0.001UF 2KV	0.001UF 2KV
C667	C-10	#	680PF 500V	#	#
C668	D-10	#	680PF 500V	#	#
CN603	A-1	#	#	1P	1P
CN604	A-1	1P	1P	#	#
D612	B-7	ERC04-06SE	ERC04-06SE	#	#
D613	B-7	ERC04-06SE	ERC04-06SE	#	#
D624	C-10	#	D10SC4M	#	#
F601	B-2	6.3A/125V	6.3A/125V	6.3A/250V	6.3A/250V
FB614	D-10	#	#	1.1UH	#
JW608	D-5	7.5MM	7.5MM	#	#
JW609	D-5	7.5MM	7.5MM	#	#
L607	C-10	#	10UH	#	#
PS601	D-10	#	1-576-337-21	#	#
R603	B-4	4.7M 1/2W	4.7M 1/2W	#	#
R612	B-6	#	#	470K 1/2W	470K 1/2W
R628	B-6	#	#	470K 1/2W	470K 1/2W
R699	B-4	#	#	8.2M 1W	8.2M 1W
T603	A-10	1-437-783-11	1-437-783-11	1-437-784-11	1-437-784-11
THP501	C-2	1-804-313-11	1-804-313-11	1-803-540-11	1-803-540-11
VDR600	B-2	1-803-585-11	1-803-585-11	1-803-967-11	1-803-967-11

#: NOT MOUNTED

**GK BOARD IC VOLTAGE LIST**

IC600		IC1405	
PIN	VOLT	PIN	VOLT
11	-157.1	3	2.4
12	-152.3	4	8.4
13	N/C	5	GND
14	7.0	<b>IC605</b>	
15	-2.6	1	10.1
16	1.9	2	GND
17	N/C	3	14.0
18	156.8	4	10.1
19		5	2.9
20		6	N/C
		<b>IC601</b>	
		<b>IC609</b>	
		<b>IC1406</b>	
1	-138.8	7	4.0
2	-157.1	8	4.0
3	134.6	9	11.0
4	N/C	10	4.6
5	9.0	11	4.6

All voltages are in V.







**GK BOARD TRANSISTOR TABLE**

	B	C	E
Q509	0.3	10.5	GND
Q605	7.6	18.8	7.6
Q606	0.0	0.5	GND
Q608	0.6	0.0	GND
Q690	6.1	0.5	5.9
Q691	6.9	7.6	7.6
Q1401	0.0	GND	0.6

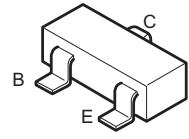
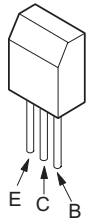
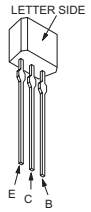
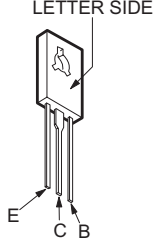
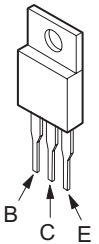
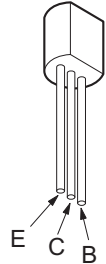
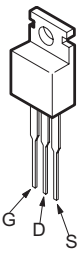
All voltages are in V.

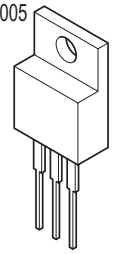
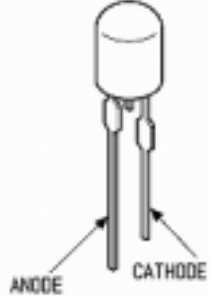
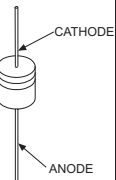
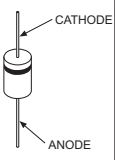
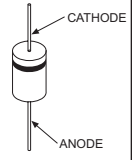
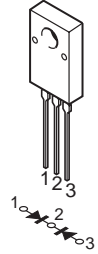
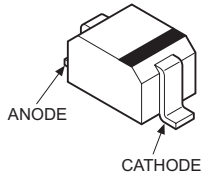
	D	G	S
Q600	156.9	2.5	-2.5
Q601	-2.6	-152.8	-157.4

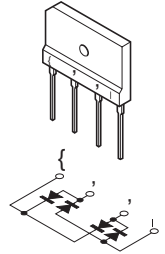
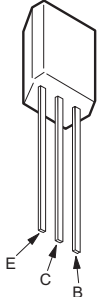
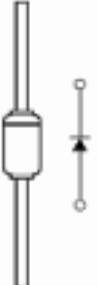
5-4. SEMICONDUCTORS

<p>2SB709A-QRS-TX 2SD601A-QRS-TX 2SC2412K-T-146-QR</p> 	<p>2SC3209LK-TP 2SD774-T-34</p> 	<p>2SD1858-Q-TV2 2SC3311A-QRSTA 2SD2144S-TP-UVV</p> 	<p>2SC3840K</p> 	<p>2SC4159-E</p> 
<p>2SA10910-TPE2</p> 	<p>IRF614</p> 	<p>SVC203SPA-AL</p> 	<p>IRFIB7N50A-LF31 2SC5511 2SA2005</p> 	<p>DAL5815</p> 
<p>D1NS4-TA2 D1NS4-TR ERA38-06TP1 ERA82-004TP5 1SS133T-77 MTZJ-T-77-3.3B MTZJ-T-77-3.6B MTZJ-T-77-3.9B MTZJ-T-77-6.2B MTZJ-T-77-6.8B MTZJ-T-77-12C MTZJ-T-77-15B MTZJ-T-77-22</p> 	<p>ERC06-15S MTZJ-T-77-5.1C MTZJ-T-77-5.6C MTZJ-T-77-7.5A MTZJ-T-77-10B MTZJ-T-77-30D RGP10-GPKG3 RGP02-17PKG23 RGP15GPKG23</p> 	<p>EL1Z-V1 ERB44-06TP1 ERC04-06SE 1SS83TD 1N4003GA 1N4937/23 GP08DPKG23 PR1004GT RGP10GPKG23 RU4AM-T3</p> 	<p>D10SC4M</p> 	<p>MA111-TX UDZSTE-1710B</p> 
<p>S1VB20</p> 	<p>D4SB60L-F</p> 	<p>2SC2668-YTP</p> 	<p>MTZJ-T-77-27</p> 	
<p>2SA933AS-QRT</p> 				

## SECTION 6: EXPLODED VIEWS

Components not identified by a part number or description are not stocked because they are seldom required for routine service.

The component parts of an assembly are indicated by the reference numbers in the far right column of the parts list and within the dotted lines of the diagram.

\* Items marked with an asterisk are not stocked since they are seldom required for routine service. Expect some delay when ordering these components.







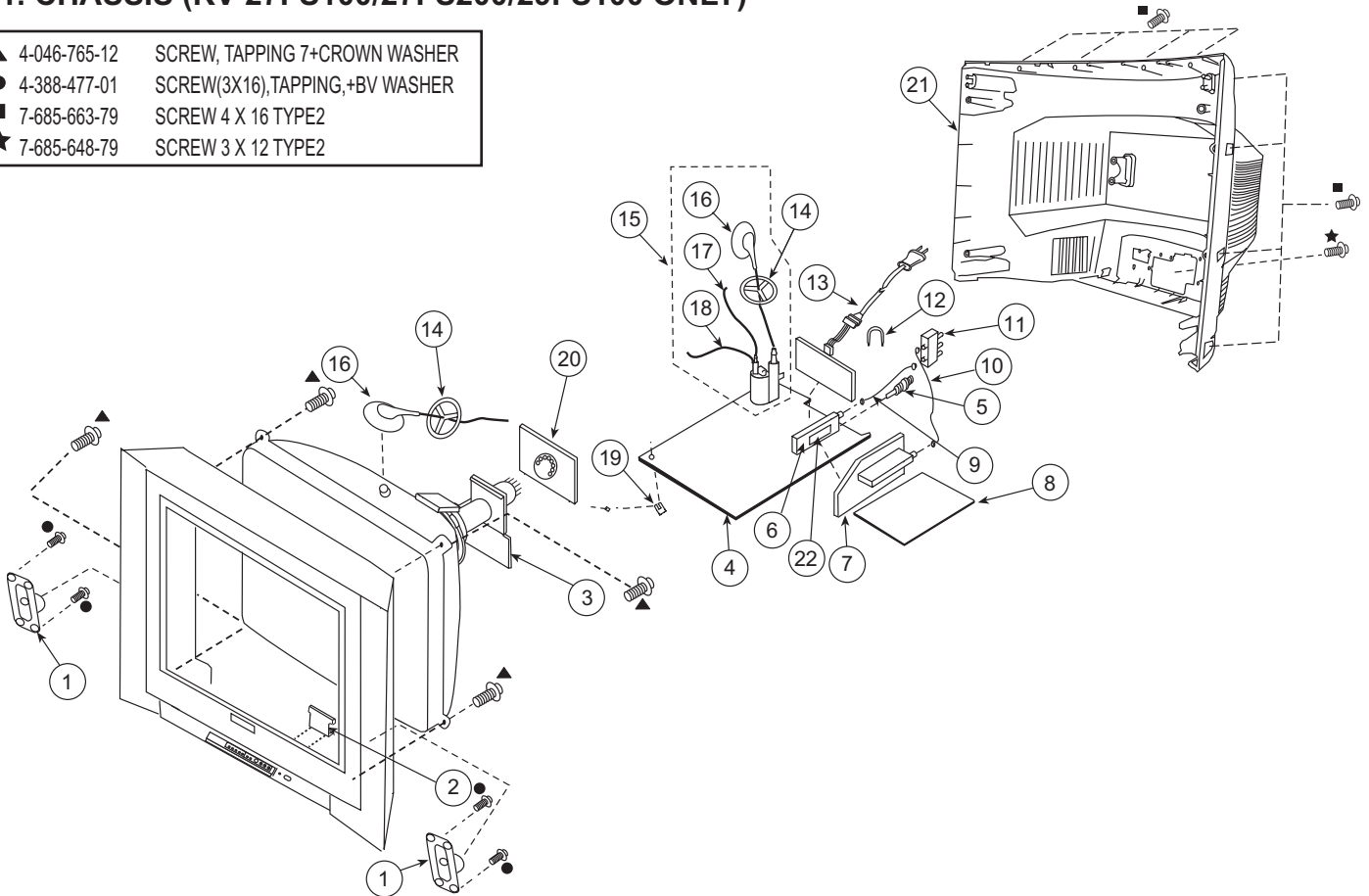

**NOTE:** The components identified by shading and  mark are critical for safety. Replace only with part number specified.

**NOTE:** Les composants identifiés par un trame et une marque  sont critiques pour la sécurité. Ne les remplacer que par une pièce portant le numéro spécifié.

### 6-1. CHASSIS (KV-27FS100/27FS200/29FS100 ONLY)

- ▲ 4-046-765-12 SCREW, TAPPING 7+CROWN WASHER
- 4-388-477-01 SCREW(3X16), TAPPING, +BV WASHER
- 7-685-663-79 SCREW 4 X 16 TYPE2
- ★ 7-685-648-79 SCREW 3 X 12 TYPE2



REF. NO.	PART NO.	DESCRIPTION	REF. NO.	PART NO.	DESCRIPTION	[Assembly Includes]
1	1-825-206-11	LOUD SPEAKER	* 9	1-555-110-00	CABLE, P-P (KV-27FS200 ONLY)	
* 2	A-1401-099-A	HS (VAR) BOARD, MOUNTED	* 10	1-558-539-21	CABLE, P-P (KV-27FS200 ONLY)	
* 3	A-1401-098-A	V (VAR) BOARD, MOUNTED	 11	1-771-787-13	SWITCH, RF ANTENNA (KV-27FS200 ONLY)	
* 4	A-1300-564-A	A BOARD, COMPLETE (KV-27FS100/29FS100 ONLY)	* 12	4-076-951-01	HINGE, PWB	
* 4	A-1300-565-A	A BOARD, COMPLETE (KV-27FS200 ONLY)	 13	1-791-935-12	CORD, AC POWER (WITH CONNECTOR) (KV-27FS100/27FS200/29FS100(N) ONLY)	
		The high voltage leads associated with the FBT on these boards are not included an must be ordered separately (SEE 16-18)	 13	1-769-796-31	CORD, POWER (WITH CONNECTOR) (KV-29FS100 (S) ONLY)	
5	1-766-374-11	PLUG, F-PIN (KV-27FS100 ONLY)	14	4-084-918-01	HOLDER, HV CABLE	
 6	8-598-593-40	TUNER, FSS BTF-WA421 (CRITICAL ON ALL EXCEPT KV-27FS200)	 15	1-453-310-11	FBT ASSY NX-4521//X4J4	(16-18)
6	8-598-593-40	TUNER, FSS BTF-WA421 (NOT CRITICAL ON KV-27FS200 ONLY)	 16	1-251-374-14	CAP ASSY, HIGH-VOLTAGE	
* 7	A-1400-456-A	P (VAR) BOARD, MOUNTED (KV-27FS200 ONLY)	 17	1-900-800-82	WIRE ASSY, FOCUS	
* 8	A-1401-097-A	GK (VAR) BOARD, MOUNTED (KV-27FS100/29FS100(N) ONLY)	 18	1-900-803-22	WIRE ASSY, G2 LEAD	
* 8	A-1401-102-A	GK (VAR) BOARD, MOUNTED (KV-27FS200 ONLY)	19	3-696-606-02	HINGE, VI	
8	A-1401-269-A	GK (VAR) BOARD, MOUNTED (KV-29FS100(S))	* 20	A-1400-455-A	C (COM) BOARD, MOUNTED	
			21	4-089-050-01	COVER, REAR	
			22	4-089-060-01	LABEL, ANTENNA (S) (KV-27FS200 ONLY)	
			22	4-089-061-01	LABEL, ANTENNA (L) (KV-27FS100/29FS100 ONLY)	



NOTE: The components identified by shading and  $\triangle$  mark are critical for safety. Replace only with part number specified.

NOTE: Les composants identifiés par un trame et une marque  $\triangle$  sont critiques pour la sécurité. Ne les remplacer que par une pièce portant le numéro spécifié.

## 6-2. PICTURE TUBE (KV-27FS100/27FS200/29FS100 ONLY)

- $\blacktriangle$  4-046-765-12 SCREW, TAPPING 7+CROWN WASHER
- $\bullet$  4-388-477-01 SCREW(3X16),TAPPING,+BV WASHER

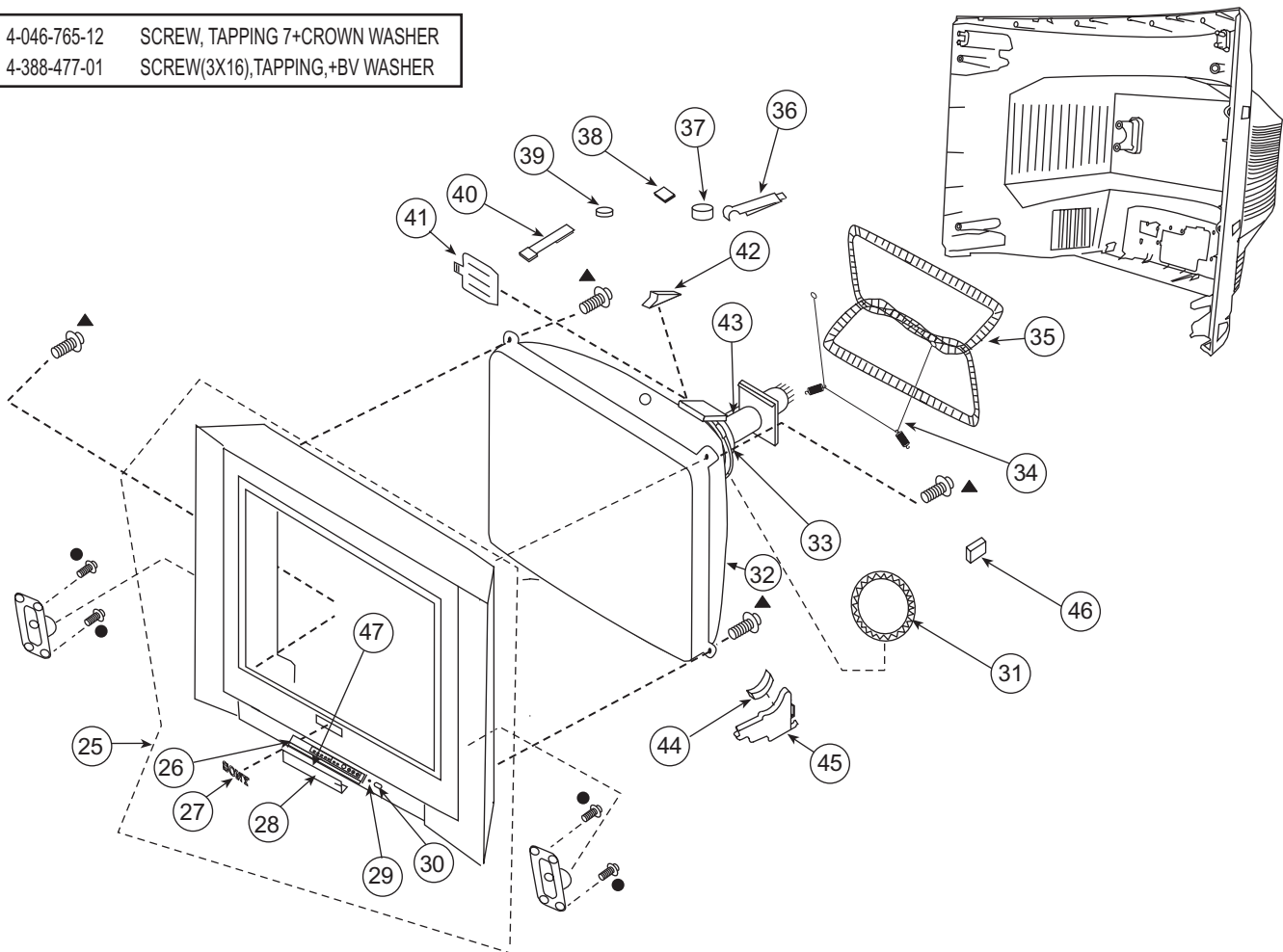

REF. NO.	PART NO.	DESCRIPTION	[Assembly Includes]	REF. NO.	PART NO.	DESCRIPTION
25	X-4040-356-1	BEZNET ASSY	(26-30, 47)	37	1-452-094-00	CIRCULAR DISC MAGNET B (ALL EXCEPT KV-32FS200)
26	4-083-303-01	SPRING, METAL		38	1-452-885-11	MAGNET, LANDING
27	4-046-160-21	EMBLEM, SONY (NO.9)		39	1-452-032-00	MAGNET, DISC
28	4-089-056-11	DOOR		40	4-083-414-01	PIECE A(110), CONV CORRECT
29	4-089-058-01	GUIDE, LED		41	4-081-170-01	PLATE, TLH CORRECTION
30	4-089-057-01	BUTTON, POWER		42	4-053-005-01	SPACER, DY
$\triangle$ 31	1-452-896-11	COIL, NA ROTATION (RT200)		$\triangle$ 43	8-453-011-11	NECK ASSEMBLY NA299-M
$\triangle$ 32	8-735-082-05	CRT 29RSN(SDP) (M68LNH050X) (KV-27FS100/27FS200/29FS100(N) ONLY)		44	4-090-578-01	CUSHION, CRT SUPPORTER
$\triangle$ 32	8-735-083-05	CRT 29RSN(SDP)(SOUTH) (M68LNH050X) (KV-29FS100 (S) ONLY)		45	4-089-062-01	CRT SUPPORTER
$\triangle$ 33	8-451-494-41	DY Y29RSA-V		46	4-078-952-01	CUSHION , 20MM X 20MM
34	4-036-329-01	SPRING (B), TENSION		47	4-089-016-01	LABEL, DOOR
$\triangle$ 35	1-419-156-21	COIL, DEGAUSSING (KV-27FS100/27FS200/29FS100(N) ONLY)				
$\triangle$ 35	1-419-523-21	COIL, DEGAUSSING (KV-29FS100(S) ONLY)				
* 36	4-062-970-12	CLIP (29RSN), DGC				

**NOTE:** The components identified by shading and  $\triangle$  mark are critical for safety. Replace only with part number specified.

**NOTE:** Les composants identifiés par un trame et une marque  $\triangle$  sont critiques pour la sécurité. Ne les remplacer que par une pièce portant le numéro spécifié.

### 6-3. CHASSIS (KV-32FS100/32FS200/34FS100 ONLY)

- $\blacktriangle$  4-046-765-12 SCREW, TAPPING 7+CROWN WASHER
- $\bullet$  4-388-477-01 SCREW(3X16),TAPPING,+BV WASHER
- $\blacksquare$  7-685-663-79 SCREW 4 X 16 TYPE2
- $\star$  7-685-648-79 SCREW 3 X 12 TYPE2

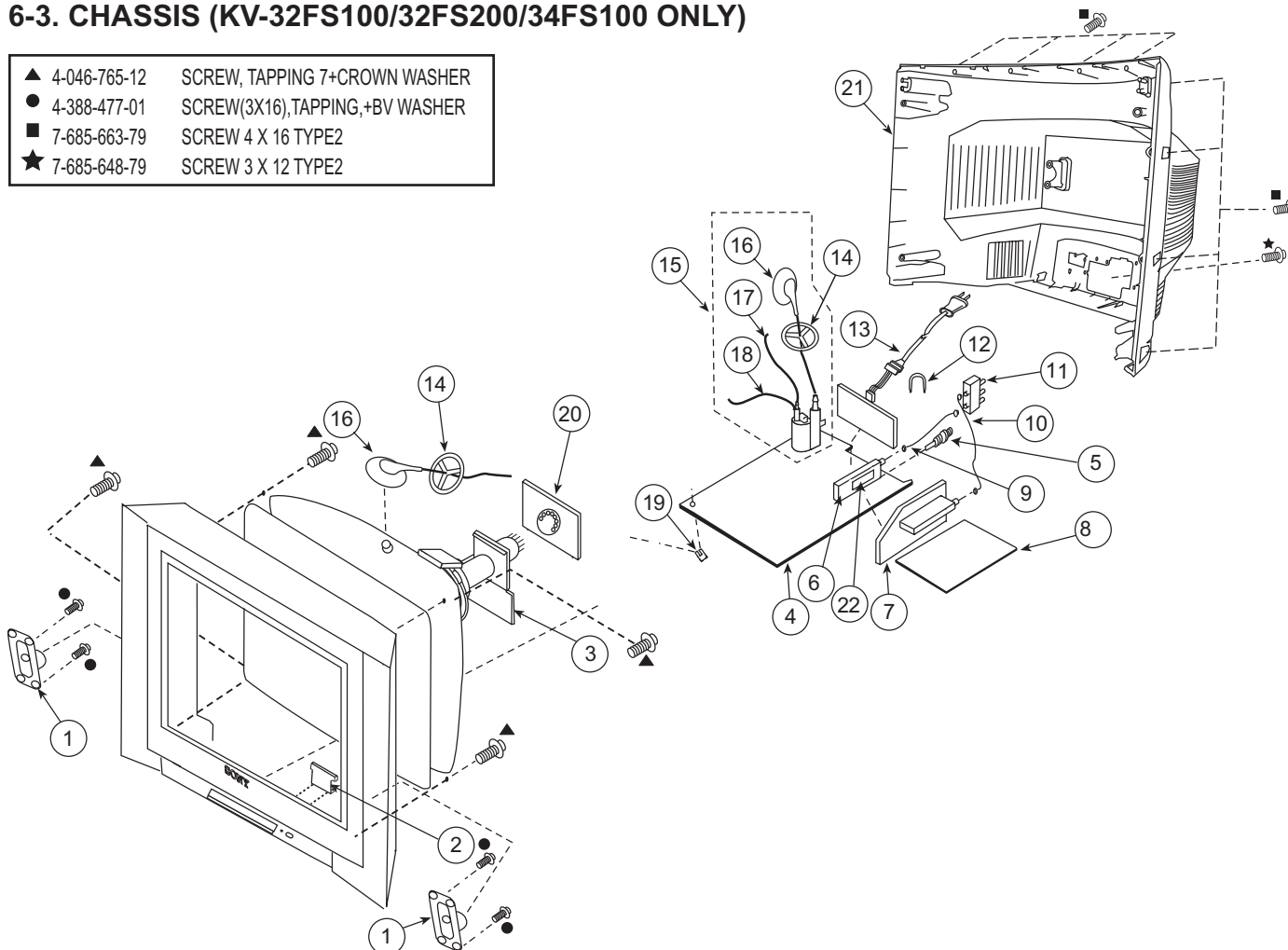

REF. NO.	PART NO.	DESCRIPTION	REF. NO.	PART NO.	DESCRIPTION	([Assembly Includes])
1	1-825-206-11	LOUD SPEAKER	* 9	1-555-110-00	CABLE, P-P (KV-32FS200 ONLY)	
* 2	A-1401-099-A	HS (VAR) BOARD, MOUNTED	* 10	1-558-539-21	CABLE, P-P (KV-32FS200 ONLY)	
* 3	A-1401-223-A	V (VAR) BOARD, MOUNTED	$\triangle$ 11	1-771-787-13	SWITCH, RF ANTENNA (KV-32FS200 ONLY)	
* 4	A-1300-633-A	A BOARD, COMPLETE (KV-32FS100/34FS100 ONLY)	* 12	4-076-951-01	HINGE, PWB	
* 4	A-1300-634-A	A BOARD, COMPLETE (KV-32FS200 ONLY)	$\triangle$ 13	1-791-935-12	CORD, AC POWER(WITH CONNECTOR) (KV-32FS100/32FS200/34FS100(N) ONLY)	
		The high-voltage leads associated with the FBT's on these boards are not included and must be ordered separately (SEE 16-18).	$\triangle$ 13	1-769-796-31	CORD, POWER (WITH CONNECTOR) (KV-34FS100(S) ONLY)	
5	1-766-374-11	PLUG, F-PIN (KV-32FS100/34FS100 ONLY)	14	4-084-918-01	HOLDER, HV CABLE	
$\triangle$ 6	8-598-593-40	TUNER, FSS BTF-WA421 (CRITICAL ON ALL EXCEPT KV-32FS200)	$\triangle$ 15	1-453-338-11	FBT ASSY NX-4600//X4J4	(16-18)
6	8-598-593-40	TUNER, FSS BTF-WA421 (NOT CRITICAL ON KV-32FS200 ONLY)	$\triangle$ 16	1-251-374-14	CAP ASSY, HIGH-VOLTAGE	
* 7	A-1400-456-A	P (VAR) BOARD, MOUNTED (KV-32FS200 ONLY)	$\triangle$ 17	1-900-800-82	WIRE ASSY, FOCUS	
* 8	A-1401-097-A	GK (VAR) BOARD, MOUNTED (KV-32FS100/34FS100(N) ONLY)	$\triangle$ 18	1-900-803-50	WIRE ASSY, G2 LEAD	
* 8	A-1401-102-A	GK (VAR) BOARD, MOUNTED (KV-32FS200 ONLY)	19	3-696-606-02	HINGE, VI	
8	A-1401-352-A	GK (VAR) BOARD, MOUNTED (KV-34FS100(S) ONLY)	* 20	A-1400-455-A	C (COM) BOARD, MOUNTED	
			21	4-089-051-01	COVER, REAR	
			22	4-089-060-01	LABEL, TUNER ANTENNA (S) (KV-32FS200 ONLY)	
			22	4-089-061-01	LABEL, TUNER ANTENNA (L) (KV-32FS100/34FS100 ONLY)	

NOTE: The components identified by shading and ⚠ mark are critical for safety. Replace only with part number specified.

NOTE: Les composants identifiés par un trame et une marque ⚠ sont critiques pour la sécurité. Ne les remplacer que par une pièce portant le numéro spécifié.

### 6-4. PICTURE TUBE (KV-32FS100/32FS200/34FS100 ONLY)

- ▲ 4-046-765-12 SCREW, TAPPING 7+CROWN WASHER
- 4-388-477-01 SCREW(3X16), TAPPING, +BV WASHER

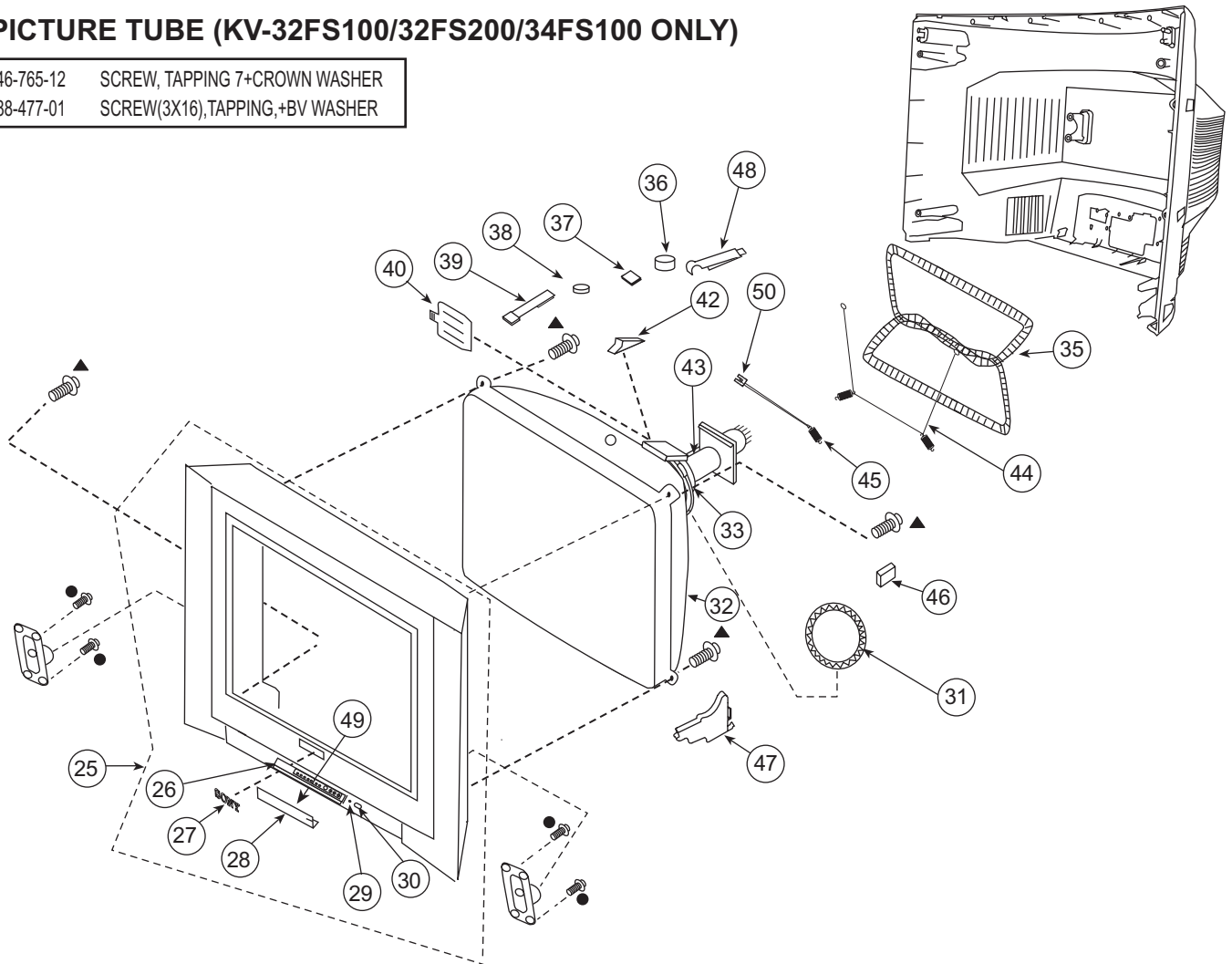

REF. NO.	PART NO.	DESCRIPTION	[Assembly Includes]	REF. NO.	PART NO.	DESCRIPTION
25	X-4040-357-1	BEZNET ASSY	(26-30, 49)	40	4-081-170-01	PLATE, TLH CORRECTION
26	4-083-303-01	SPRING, METAL		42	4-053-005-01	SPACER, DY
27	4-046-160-21	EMBLEM, SONY (NO.9)		▲ 43	8-453-007-41	NECK ASSEMBLY NA324-M4 (KV-32FS100/32FS200/34FS100(N)(S) ONLY)
28	4-089-056-11	DOOR		44	4-036-329-01	SPRING (B), TENSION
29	4-089-058-01	GUIDE, LED		45	4-082-641-01	SPRING, 45MM (KV-34FS100(S) ONLY)
30	4-089-057-01	BUTTON, POWER		46	4-078-952-01	CUSHION, 20MM X 20MM
▲ 31	1-452-896-11	COIL, NA ROTATION (RT200)		47	4-089-063-01	SUPPORTER, CRT
▲ 32	8-735-066-05	CRT 34RSN(SDP) (A80LPD50X)		48	4-065-895-11	HOLDER, DGC
33	8-451-499-41	DY Y34RSA-V		49	4-089-016-01	LABEL, DOOR
▲ 35	1-428-988-11	COIL, DEGAUSSING (KV-32FS100/32FS200/34FS100(N) ONLY)		50	4-082-640-01	HOOK, GROUND WIRE (KV-34FS100 (S) ONLY)
▲ 35	1-428-990-11	COIL, DEGAUSSING (KV-34FS100(S) ONLY)				
36	1-452-094-00	CIRCULAR DISC MAGNET B (ALL EXCEPT KV-32FS200)				
37	1-452-885-11	MAGNET, LANDING				
38	1-452-032-00	MAGNET, DISC				
39	4-083-414-01	PIECE A(110), CONV CORRECT				























REF. NO.	PART NO.	DESCRIPTION	VALUES			REF. NO.	PART NO.	DESCRIPTION	VALUES		
C057	1-135-834-91	CERAMIC CHIP	2.2μF		6.3V	C338	1-107-826-11	CERAMIC CHIP	0.1μF	10%	16V
C060	1-164-230-11	CERAMIC CHIP	220pF	5%	50V	C339	1-113-619-11	CERAMIC CHIP	0.47μF		10V
C062	1-125-837-91	CERAMIC CHIP	1μF	10%	6.3V	C340	1-126-767-11	ELECT	1000μF	20%	16V
C065	1-125-891-11	CERAMIC CHIP	0.47μF	10%	10V	C341	1-126-947-11	ELECT	47μF	20%	25V
C101	1-115-416-11	CERAMIC CHIP	0.001μF	5%	25V	C343	1-107-826-11	CERAMIC CHIP	0.1μF	10%	16V
C102	1-115-416-11	CERAMIC CHIP	0.001μF	5%	25V	C344	1-162-970-11	CERAMIC CHIP	0.01μF	10%	25V
C111	1-164-230-11	CERAMIC CHIP (KV-27FS200/32FS200 ONLY)	220pF	5%	50V	C345	1-113-619-11	CERAMIC CHIP	0.47μF		10V
C120	1-162-915-11	CERAMIC CHIP	10pF	0.50pF	50V	C346	1-162-970-11	CERAMIC CHIP (KV-27FS200/32FS200 ONLY)	0.01μF	10%	25V
C121	1-162-915-11	CERAMIC CHIP	10pF	0.50pF	50V	C347	1-162-970-11	CERAMIC CHIP (KV-27FS200/32FS200 ONLY)	0.01μF	10%	25V
C122	1-107-826-11	CERAMIC CHIP	0.1μF	10%	16V	C348	1-162-970-11	CERAMIC CHIP (ALL EXCEPT KV-27FS200/32FS200)	0.01μF	10%	25V
C200	1-107-826-11	CERAMIC CHIP	0.1μF	10%	16V	C349	1-162-970-11	CERAMIC CHIP (ALL EXCEPT KV-27FS200/32FS200)	0.01μF	10%	25V
C201	1-107-826-11	CERAMIC CHIP	0.1μF	10%	16V	C350	1-162-970-11	CERAMIC CHIP (ALL EXCEPT KV-27FS200/32FS200)	0.01μF	10%	25V
C202	1-107-826-11	CERAMIC CHIP	0.1μF	10%	16V	C351	1-162-970-11	CERAMIC CHIP (KV-27FS200/32FS200 ONLY)	0.01μF	10%	25V
C203	1-107-826-11	CERAMIC CHIP	0.1μF	10%	16V	C352	1-126-947-11	ELECT	47μF	20%	25V
C206	1-107-826-11	CERAMIC CHIP	0.1μF	10%	16V	C353	1-107-826-11	CERAMIC CHIP	0.1μF	10%	16V
C207	1-107-826-11	CERAMIC CHIP	0.1μF	10%	16V	C354	1-162-970-11	CERAMIC CHIP	0.01μF	10%	25V
C208	1-107-826-11	CERAMIC CHIP	0.1μF	10%	16V	C355	1-162-970-11	CERAMIC CHIP	0.01μF	10%	25V
C209	1-107-826-11	CERAMIC CHIP	0.1μF	10%	16V	C356	1-162-970-11	CERAMIC CHIP	0.01μF	10%	25V
C212	1-126-963-11	ELECT	4.7μF	20%	50V	C357	1-126-960-11	ELECT	1μF	20%	50V
C213	1-126-963-11	ELECT	4.7μF	20%	50V	C358	1-162-970-11	CERAMIC CHIP	0.01μF	10%	25V
C302	1-126-963-11	ELECT	4.7μF	20%	50V	C359	1-162-961-11	CERAMIC CHIP	330pF	10%	50V
C303	1-107-826-11	CERAMIC CHIP	0.1μF	10%	16V	C360	1-126-960-11	ELECT	1μF	20%	50V
C304	1-113-619-11	CERAMIC CHIP	0.47μF		10V	C364	1-162-923-11	CERAMIC CHIP	47pF	5%	50V
C309	1-107-826-11	CERAMIC CHIP	0.1μF	10%	16V	C365	1-162-117-00	CERAMIC	100pF	10%	500V
C311	1-126-947-11	ELECT	47μF	20%	25V	C366	1-113-619-11	CERAMIC CHIP	0.47μF		10V
C313	1-107-826-11	CERAMIC CHIP	0.1μF	10%	16V	C367	1-113-619-11	CERAMIC CHIP	0.47μF		10V
C317	1-162-917-11	CERAMIC CHIP	15pF	5%	50V	C368	1-113-619-11	CERAMIC CHIP	0.47μF		10V
C318	1-126-933-11	ELECT	100μF	20%	16V	C372	1-162-970-11	CERAMIC CHIP	0.01μF	10%	25V
C319	1-107-826-11	CERAMIC CHIP	0.1μF	10%	16V	C373	1-162-964-11	CERAMIC CHIP	0.001μF	10%	50V
C320	1-126-959-11	ELECT	0.47μF	20%	50V	C374	1-126-933-11	ELECT	100μF	20%	16V
C321	1-126-947-11	ELECT	47μF	20%	25V	C375	1-162-970-11	CERAMIC CHIP	0.01μF	10%	25V
C322	1-107-826-11	CERAMIC CHIP	0.1μF	10%	16V	C376	1-107-826-11	CERAMIC CHIP	0.1μF	10%	16V
C325	1-162-923-11	CERAMIC CHIP	47pF	5%	50V	C377	1-162-963-11	CERAMIC CHIP	680pF	10%	50V
C326	1-164-373-11	CERAMIC CHIP (ALL EXCEPT KV-32FS200)	0.033μF		25V	C378	1-162-970-11	CERAMIC CHIP	0.01μF	10%	25V
C326	1-162-968-11	CERAMIC CHIP (KV-32FS200 ONLY)	0.0047μF	10%	50V	C379	1-162-970-11	CERAMIC CHIP	0.01μF	10%	25V
C327	1-216-864-11	SHORT CHIP	0			C380	1-162-970-11	CERAMIC CHIP	0.01μF	10%	25V
C330	1-126-964-11	ELECT	10μF	20%	50V	C381	1-162-970-11	CERAMIC CHIP	0.01μF	10%	25V
C332	1-162-917-11	CERAMIC CHIP	15pF	5%	50V	C382	1-162-970-11	CERAMIC CHIP	0.01μF	10%	25V
C333	1-126-963-11	ELECT	4.7μF	20%	50V						
C335	1-162-918-11	CERAMIC CHIP	18pF	5%	50V						
C337	1-164-315-11	CERAMIC CHIP	470pF	5%	50V						

NOTE: The components identified by shading and  mark are critical for safety. Replace only with part number specified.

NOTE: Les composants identifiés par un trame et une  sont critiques pour la sécurité. Ne les remplacer que par une pièce portant le numéro spécifique.









REF. NO.	PART NO.	DESCRIPTION	VALUES	REF. NO.	PART NO.	DESCRIPTION	VALUES
C383	1-126-933-11	ELECT	100µF 20% 16V	 C511	1-117-652-11	FILM	22000pF 3% 1.2KV
C384	1-162-970-11	CERAMIC CHIP	0.01µF 10% 25V			(KV-32FS100/32FS200/34FS100(N)(S) ONLY)	
C385	1-162-970-11	CERAMIC CHIP	0.01µF 10% 25V	 C511	1-136-086-00	FILM	17000pF 1.2KV
C387	1-162-970-11	CERAMIC CHIP	0.01µF 10% 25V			(KV-27FS100/27FS200/29FS100(N)(S) ONLY)	
C388	1-126-933-11	ELECT	100µF 20% 16V	C512	1-129-928-00	FILM	0.0027µF 10% 630V
C389	1-162-970-11	CERAMIC CHIP	0.01µF 10% 25V	 C513	1-129-722-00	FILM	0.047µF 630V
						(KV-27FS100/27FS200/29FS100(N)(S) ONLY)	
C390	1-126-933-11	ELECT	100µF 20% 16V	 C513	1-130-118-91	FILM	0.051µF 5% 400V
C393	1-107-826-11	CERAMIC CHIP	0.1µF 10% 16V			(KV-32FS100/32FS200/34FS100(N)(S) ONLY)	
C394	1-125-891-11	CERAMIC CHIP	0.47µF 10% 10V	 C514	1-109-844-11	FILM	0.68µF 5% 400V
C396	1-162-917-11	CERAMIC CHIP	15pF 5% 50V			(KV-27FS100/27FS200/29FS100(N)(S) ONLY)	
C401	1-162-969-11	CERAMIC CHIP	0.0068µF 10% 25V	 C514	1-115-521-11	FILM	0.82µF 5% 250V
						(KV-32FS100/32FS200/34FS100(N)(S) ONLY)	
C402	1-164-227-11	CERAMIC CHIP	0.022µF 10% 25V	C515	1-104-987-11	MYLAR	0.001µF 10% 100V
C403	1-162-967-11	CERAMIC CHIP	0.0033µF 10% 50V	 C516	1-115-521-11	FILM	0.82µF 5% 250V
C404	1-162-967-11	CERAMIC CHIP	0.0033µF 10% 50V			(KV-32FS100/32FS200/34FS100(N)(S) ONLY)	
C405	1-164-677-11	CERAMIC CHIP	0.033µF 10% 16V	 C516	1-115-522-11	FILM	1µF 5% 250V
C406	1-164-677-11	CERAMIC CHIP	0.033µF 10% 16V			(KV-27FS100/27FS200/29FS100(N)(S) ONLY)	
C407	1-162-965-11	CERAMIC CHIP	0.0015µF 10% 50V	C517	1-107-649-11	ELECT	2.2µF 20% 250V
C408	1-162-965-11	CERAMIC CHIP	0.0015µF 10% 50V	C518	1-106-387-00	MYLAR	0.068µF 10% 200V
C409	1-127-715-91	CERAMIC CHIP	0.22µF 10% 16V	C519	1-107-612-11	CERAMIC	100pF 5% 500V
C410	1-127-715-91	CERAMIC CHIP	0.22µF 10% 16V	C520	1-164-646-11	CERAMIC	2200pF 10% 500V
C411	1-128-934-91	CERAMIC CHIP	0.33µF 20% 10V	C521	1-162-964-11	CERAMIC CHIP	0.001µF 10% 50V
C412	1-126-961-11	ELECT	2.2µF 20% 50V	C522	1-126-960-11	ELECT	1µF 20% 50V
C413	1-126-960-11	ELECT	1µF 20% 50V	C525	1-102-244-00	CERAMIC	220pF 10% 500V
C414	1-126-960-11	ELECT	1µF 20% 50V	C526	1-107-662-11	ELECT	22µF 20% 250V
C415	1-126-960-11	ELECT	1µF 20% 50V	 C527	1-162-116-00	CERAMIC	680pF 10% 2KV
C416	1-126-960-11	ELECT	1µF 20% 50V	C528	1-162-966-11	CERAMIC CHIP	0.0022µF 10% 50V
C417	1-115-416-11	CERAMIC CHIP	0.001µF 5% 25V	C529	1-128-551-11	ELECT	22µF 20% 25V
C418	1-126-963-11	ELECT	4.7µF 20% 50V	C530	1-130-475-00	MYLAR	0.0022µF 5% 50V
C420	1-126-960-11	ELECT	1µF 20% 50V	 C531	1-126-965-91	ELECT	22µF 20% 50V
C422	1-126-935-11	ELECT	470µF 20% 16V	 C532	1-126-965-91	ELECT	22µF 20% 50V
C452	1-107-826-11	CERAMIC CHIP	0.1µF 10% 16V	C534	1-126-967-11	ELECT	47µF 20% 50V
		(KV-27FS200/32FS200 ONLY)					
C453	1-107-826-11	CERAMIC CHIP	0.1µF 10% 16V	 C535	1-164-360-11	CERAMIC CHIP	0.1µF 16V
		(KV-27FS200/32FS200 ONLY)		C537	1-126-941-11	ELECT	470µF 20% 25V
C501	1-102-110-00	CERAMIC	220pF 10% 50V	C539	1-126-941-11	ELECT	470µF 20% 25V
C502	1-126-959-11	ELECT	0.47µF 20% 50V	C540	1-107-995-11	ELECT	100µF 160V
C503	1-164-315-11	CERAMIC CHIP	470pF 5% 50V	C541	1-128-560-11	ELECT	22µF 20% 100V
C504	1-102-228-00	CERAMIC	470pF 10% 500V	C542	1-102-244-00	CERAMIC	220pF 10% 500V
C505	1-102-228-00	CERAMIC	470pF 10% 500V			(KV-32FS100/32FS200/34FS100(N)(S) ONLY)	
C506	1-106-383-00	MYLAR	0.047µF 10% 200V	C544	1-129-718-00	FILM	0.022µF 5% 630V
 C507	1-162-116-00	CERAMIC	680pF 10% 2KV	C545	1-106-387-00	MYLAR	0.068µF 10% 200V
C508	1-102-228-00	CERAMIC	470pF 10% 500V	C546	1-104-987-11	MYLAR	0.001µF 10% 100V
 C509	1-162-116-00	CERAMIC	680pF 10% 2KV			(KV-32FS100/32FS200/34FS100(N)(S) ONLY)	
 C510	1-137-150-11	MYLAR	0.01µF 10% 100V				





NOTE: The components identified by shading and  mark are critical for safety. Replace only with part number specified.









NOTE: Les composants identifiés par un trame et une  sont critiques pour la sécurité. Ne les remplacer que par une pièce portant le numéro spécifique.

REF. NO.	PART NO.	DESCRIPTION	VALUES			REF. NO.	PART NO.	DESCRIPTION	VALUES
C547	1-104-987-11	MYLAR (KV-32FS100/32FS200/34FS100(N)(S) ONLY)	0.001μF	10%	100V	<b>DIODE</b>			
C550	1-102-002-00	CERAMIC	680pF	10%	500V	D002	8-719-109-93	DIODE MTZJ-T-77-6.2C	
C551	1-109-954-11	ELECT	0.47μF	20%	160V	D004	8-719-921-44	DIODE MTZJ-T-77-5.1C	
C552	1-102-244-00	CERAMIC	220pF	10%	500V	D005	8-719-110-17	DIODE MTZJ-T-77-10B	
 C553	1-107-846-11	FILM (KV-27FS100/27FS200/29FS100(N)(S) ONLY)	0.1μF	5%	400V	D006	8-719-110-17	DIODE MTZJ-T-77-10B	
 C553	1-117-667-11	FILM (KV-32FS100/32FS200/34FS100(N)(S) ONLY)	0.47μF	5%	250V	D007	8-719-404-50	DIODE MA111-TX	
 C554	1-117-629-11	FILM (KV-27FS100/27FS200/29FS100(N)(S) ONLY)	2700pF	3%	1.2KV	D008	8-719-404-50	DIODE MA111-TX	
 C554	1-117-635-11	FILM (KV-32FS100/32FS200/34FS100(N)(S) ONLY)	4700pF	3%	1.2KV	D009	8-719-982-22	DIODE MTZJ-T-77-30D	
C561	1-126-967-11	ELECT	47μF	20%	50V	D010	8-719-109-93	DIODE MTZJ-T-77-6.2C	
C563	1-104-666-11	ELECT	220μF	20%	25V	D100	8-719-929-15	DIODE MTZJ-T-77-9.1B	
C564	1-126-960-11	ELECT	1μF	20%	50V	D101	8-719-929-15	DIODE MTZJ-T-77-9.1B	
C565	1-126-969-11	ELECT	220μF	20%	50V	D102	8-719-109-85	DIODE MTZJ-T-77-5.1B	
C568	1-136-169-00	FILM	0.22μF	5%	50V	D110	8-719-991-33	DIODE 1SS133T-77	
C571	1-126-942-61	ELECT	1000μF	20%	25V	D111	8-719-109-93	DIODE MTZJ-T-77-6.2B	
C572	1-126-942-61	ELECT	1000μF	20%	25V	D112	8-719-109-93	DIODE MTZJ-T-77-6.2B	
C573	1-104-665-11	ELECT	100μF	20%	25V	D113	8-719-921-44	DIODE MTZJ-T-77-5.1C	
 C590	1-126-964-11	ELECT	10μF	20%	50V	D200	8-719-929-15	DIODE MTZJ-T-77-9.1B	
C1501	1-107-846-11	FILM (KV-32FS100/32FS200/34FS100(N)(S) ONLY)	0.1μF	5%	250V	D201	8-719-929-15	DIODE MTZJ-T-77-9.1B	
C6001	1-126-940-11	ELECT	330μF	20%	25V	D209	8-719-929-15	DIODE MTZJ-T-77-9.1B	
C6002	1-126-947-11	ELECT	47μF	20%	25V	D210	8-719-929-15	DIODE MTZJ-T-77-9.1B	
C6003	1-125-837-91	CERAMIC CHIP	1μF	10%	6.3V	D211	8-719-929-15	DIODE MTZJ-T-77-9.1B	
C6005	1-126-768-11	ELECT	2200μF	20%	16V	D212	8-719-929-15	DIODE MTZJ-T-77-9.1B	
<b>CONNECTOR</b>									
* CN001	1-560-124-00	PLUG,CONNECTOR (2.5MM)	4P						
* CN002	1-564-507-11	PLUG,CONNECTOR (KV-27FS200/32FS200 ONLY)	4P						
* CN003	1-564-509-11	PLUG,CONNECTOR	6P						
* CN004	1-564-507-11	PLUG,CONNECTOR	4P						
* CN303	1-564-511-11	PLUG,CONNECTOR	8P						
* CN501	1-580-798-11	CONNECTOR PIN (DY)	6P						
* CN503	1-564-510-11	PLUG,CONNECTOR	7P						
* CN504	1-564-509-11	PLUG,CONNECTOR	6P						
* CN505	1-564-510-11	PLUG,CONNECTOR	7P						
CN600	1-695-915-11	TAB (CONTACT)							
* CN906	1-564-506-11	PLUG,CONNECTOR	3P						
* CN3300	1-691-616-21	CONNECTOR, BOARD TO BOARD 15P (KV-27FS200/32FS200 ONLY)							
* CN3301	1-691-616-21	CONNECTOR, BOARD TO BOARD 15P (KV-27FS200/32FS200 ONLY)							
						D303	8-719-929-15	DIODE MTZJ-T-77-9.1B	
						D304	8-719-921-44	DIODE MTZJ-T-77-5.1C	
						D305	8-719-929-15	DIODE MTZJ-T-77-9.1B	
						D306	8-719-929-15	DIODE MTZJ-T-77-9.1B	
						D307	8-719-929-15	DIODE MTZJ-T-77-9.1B	
						D309	8-719-929-15	DIODE MTZJ-T-77-9.1B	
						D310	8-719-929-15	DIODE MTZJ-T-77-9.1B	
						D311	8-719-929-15	DIODE MTZJ-T-77-9.1B	
						D320	8-719-991-33	DIODE 1SS133T-77 (KV-27FS200/32FS200 ONLY)	
						D410	8-719-404-50	DIODE MA111-TX	
						D412	8-719-404-50	DIODE MA111-TX	
						D413	8-719-921-63	DIODE MTZJ-T-77-7.5B	
						D415	8-719-991-33	DIODE 1SS133T-77	
						D501	8-719-109-89	DIODE MTZJ-T-77-5.6C	
						D502	8-719-945-80	DIODE ERC06-15S	
						 D503	8-719-945-80	DIODE ERC06-15S	
						D504	8-719-312-10	DIODE RU4AM-T3	
						D505	8-719-908-03	DIODE GP08DPKG23	





**NOTE:** The components identified by shading and  mark are critical for safety. Replace only with part number specified.











**NOTE:** Les composants identifiés par un trame et une marque  sont critiques pour la sécurité. Ne les remplacer que par une pièce portant le numéro spécifique.

REF. NO.	PART NO.	DESCRIPTION	VALUES	REF. NO.	PART NO.	DESCRIPTION	VALUES
D506	8-719-908-03	DIODE GP08DPKG23		IC302	6-701-597-01	IC TC90A69N	
D507	8-719-991-33	DIODE 1SS133T-77		IC400	6-701-753-01	IC NJW1135GK1-TE2	
 D508	8-719-991-33	DIODE 1SS133T-77		IC501	8-759-700-07	IC NJM2903M-TE2	
D510	8-719-081-93	DIODE 1N4937/23		 IC561	8-759-696-71	IC STV9379 (KV-32FS100/32FS200/34FS100(N)(S) ONLY)	
D511	8-719-970-87	DIODE ERA38-06TP1					
D512	8-719-970-87	DIODE ERA38-06TP1		 IC561	8-759-980-58	IC TDA8172 (KV-27FS100/27FS200/29FS100(N)(S) ONLY)	
D513	8-719-110-41	DIODE MTZJ-T-77-15B		IC6008	6-701-752-01	IC NJM2930F05	
 D515	8-719-075-41	DIODE PR1004GT		<b>JACK</b>			
D516	8-719-991-33	DIODE 1SS133T-77		J201	1-794-119-11	TERMINAL BLOCK, S	4P
D518	8-719-991-33	DIODE 1SS133T-77		J203	1-794-118-11	JACK BLOCK, PIN	3P
 D519	8-719-302-43	DIODE EL1Z-V1		J205	1-794-116-11	JACK BLOCK, PIN	2P
 D520	8-719-991-33	DIODE 1SS133T-77		J206	1-794-117-11	JACK BLOCK, PIN	3P
D521	8-719-921-63	DIODE MTZJ-T-77-7.5X		J207	1-794-116-11	JACK BLOCK, PIN	2P
 D522	8-719-991-33	DIODE 1SS133T-77		<b>CHIP CONDUCTOR</b>			
D523	8-719-109-69	DIODE MTZJ-T-77-3.6B		JR1	1-216-864-11	SHORT CHIP	0
D524	8-719-109-97	DIODE MTZJ-T-77-6.8B		JR2	1-216-864-11	SHORT CHIP	0
 D530	8-719-979-85	DIODE RGP15GPKG23		JR4	1-216-864-11	SHORT CHIP	0
D531	8-719-979-85	DIODE RGP15GPKG23		JR6	1-216-864-11	SHORT CHIP	0
D534	8-719-302-43	DIODE RGP10GPKG23		JR8	1-216-864-11	SHORT CHIP	0
D535	8-719-404-50	DIODE MA111-TX		JR9	1-216-864-11	SHORT CHIP	0
D536	1-216-864-11	SHORT CHIP	0	JR12	1-216-864-11	SHORT CHIP	0
D561	8-719-075-33	DIODE 1N4003GA		JR13	1-216-864-11	SHORT CHIP	0
 D580	8-719-991-33	DIODE 1SS133T-77		JR14	1-216-864-11	SHORT CHIP	0
D590	8-719-991-33	DIODE 1SS133T-77		JR15	1-216-864-11	SHORT CHIP	0
<b>FERRITE BEAD</b>				JR16	1-216-864-11	SHORT CHIP	0
FB301	1-412-911-11	FERRITE	0 $\mu$ H	JR205	1-216-864-11	SHORT CHIP	0
FB302	1-414-234-22	FERRITE	0 $\mu$ H	JR206	1-216-864-11	SHORT CHIP	0
FB501	1-410-397-21	FERRITE	1.1 $\mu$ H	JR301	1-216-864-11	SHORT CHIP	0
FB502	1-410-397-21	FERRITE	1.1 $\mu$ H	JR302	1-216-864-11	SHORT CHIP	0
FB503	1-410-397-21	FERRITE	1.1 $\mu$ H	JR303	1-216-864-11	SHORT CHIP	0
FB504	1-410-397-21	FERRITE	1.1 $\mu$ H	JR304	1-216-864-11	SHORT CHIP	0
FB505	1-410-397-21	FERRITE	1.1 $\mu$ H	JR305	1-216-864-11	SHORT CHIP	0
<b>FILTER</b>				JR306	1-216-864-11	SHORT CHIP	0
FL301	1-239-847-11	FILTER, LOW PASS		JR307	1-216-864-11	SHORT CHIP	0
FL302	1-239-847-11	FILTER, LOW PASS		JR308	1-216-864-11	SHORT CHIP (KV-27FS200/32FS200 ONLY)	0
FL303	1-239-847-11	FILTER, LOW PASS		JR309	1-216-864-11	SHORT CHIP	0
<b>IC</b>				JR311	1-216-864-11	SHORT CHIP	0
IC001	6-801-165-01	IC M306V5ME-109SP		JR312	1-216-864-11	SHORT CHIP	0
IC002	6-701-929-01	IC BD4743G-TR					
IC003	8-759-641-86	IC BR24C16F-E2					
IC301	8-752-100-49	IC CXA2154AS					





NOTE: The components identified by shading and  mark are critical for safety. Replace only with part number specified.

NOTE: Les composants identifiés par un trame et une marque  sont critiques pour la sécurité. Ne les remplacer que par une pièce portant le numéro spécifique.



REF. NO.	PART NO.	DESCRIPTION	VALUES	REF. NO.	PART NO.	DESCRIPTION	VALUES
JR401	1-216-864-11	SHORT CHIP	0	Q300	8-729-424-02	TRANSISTOR 2SB709A-QRS-TX	
JR402	1-216-864-11	SHORT CHIP	0	Q301	8-729-422-27	TRANSISTOR 2SD601A-QRS-TX	
JR403	1-216-864-11	SHORT CHIP	0	Q302	8-729-424-02	TRANSISTOR 2SB709A-QRS-TX	
JR415	1-216-864-11	SHORT CHIP	0	Q303	8-729-422-27	TRANSISTOR 2SD601A-QRS-TX	
JR420	1-216-864-11	SHORT CHIP	0	Q304	8-729-422-27	TRANSISTOR 2SD601A-QRS-TX	
JR421	1-216-864-11	SHORT CHIP	0	Q305	8-729-424-02	TRANSISTOR 2SB709A-QRS-TX	
JR423	1-216-864-11	SHORT CHIP	0	Q306	8-729-422-27	TRANSISTOR 2SD601A-QRS-TX	
<b>COIL</b>				Q307	8-729-424-02	TRANSISTOR 2SB709A-QRS-TX	
L001	1-410-482-31	INDUCTOR	100µH	Q308	8-729-424-02	TRANSISTOR 2SB709A-QRS-TX	
L002	1-410-482-31	INDUCTOR	100µH	Q309	8-729-424-02	TRANSISTOR 2SB709A-QRS-TX	
L003	1-412-029-11	INDUCTOR	10µH	Q313	8-729-424-02	TRANSISTOR 2SB709A-QRS-TX	
L004	1-410-482-31	INDUCTOR	100µH	Q317	8-729-422-27	TRANSISTOR 2SD601A-QRS-TX	
L009	1-410-482-31	INDUCTOR	100µH	Q319	8-729-422-27	TRANSISTOR 2SD601A-QRS-TX	
L010	1-414-182-11	INDUCTOR	6.8µH	Q320	8-729-424-02	TRANSISTOR 2SB709A-QRS-TX	
L300	1-410-482-31	INDUCTOR	100µH	Q321	8-729-424-02	TRANSISTOR 2SB709A-QRS-TX	
L301	1-410-482-31	INDUCTOR	100µH	Q402	8-729-422-27	TRANSISTOR 2SD601A-QRS-TX	
L302	1-412-029-11	INDUCTOR	10µH	Q403	8-729-422-27	TRANSISTOR 2SD601A-QRS-TX	
L303	1-410-478-11	INDUCTOR	47µH	Q407	8-729-422-27	TRANSISTOR 2SD601A-QRS-TX	
L304	1-410-470-11	INDUCTOR	10µH	Q501	8-729-140-50	TRANSISTOR 2SC3209LK-TP	
L305	1-410-470-11	INDUCTOR	10µH	 Q502	6-550-107-01	TRANSISTOR 2SD2645-YB	
L306	1-410-470-11	INDUCTOR	10µH	Q507	8-729-043-95	TRANSISTOR 2SC3840K	
L307	1-410-470-11	INDUCTOR	10µH	 Q511	8-729-120-28	TRANSISTOR 2SC2412K-T-146-QR	
L310	1-410-470-11	INDUCTOR	10µH	 Q512	8-729-809-29	TRANSISTOR 2SC4159-E	
L501	1-406-677-11	INDUCTOR	10MH	 Q530	8-729-422-27	TRANSISTOR 2SD601A-QRS-TX	
L502	1-412-552-11	INDUCTOR	2.2MH	 Q531	8-729-424-02	TRANSISTOR 2SB709A-QRS-TX	
L503	1-406-677-11	INDUCTOR	10MH	 Q532	8-729-200-17	TRANSISTOR 2SA10910-TPE2	
L504	1-406-677-11	INDUCTOR	10MH	Q561	8-729-422-27	TRANSISTOR 2SD601A-QRS-TX	
 L505	1-406-976-11	INDUCTOR	68µH (KV-32FS100/32FS200/34FS100(N)(S) ONLY)	Q562	8-729-120-28	TRANSISTOR 2SC2412K-T-146-QR	
 L505	1-406-978-11	INDUCTOR	150µH (KV-27FS100/27FS200/29FS100(N)(S) ONLY)	 Q590	8-729-422-27	TRANSISTOR 2SD601A-QRS-TX	
L511	1-409-955-11	INDUCTOR	8MH	Q6000	8-729-422-27	TRANSISTOR 2SD601A-QRS-TX	
L517	1-412-552-11	INDUCTOR	2.2MH	<b>RESISTOR</b>			
<b>TRANSISTOR</b>				R001	1-249-429-11	CARBON	10K 5% 1/4W
Q001	8-729-424-02	TRANSISTOR 2SB709A-QRS-TX		R002	1-249-409-11	CARBON	220 5% 1/4W
Q002	8-729-422-27	TRANSISTOR 2SD601A-QRS-TX		R003	1-216-817-11	RES-CHIP	470 5% 1/10W
 Q003	8-729-422-27	TRANSISTOR 2SD601A-QRS-TX		R004	1-216-857-11	RES-CHIP	1M 5% 1/10W
Q004	8-729-422-27	TRANSISTOR 2SD601A-QRS-TX		R005	1-216-821-11	RES-CHIP	1K 5% 1/10W
Q005	8-729-422-27	TRANSISTOR 2SD601A-QRS-TX		R006	1-249-417-11	CARBON	1K 5% 1/4W
Q010	8-729-424-02	TRANSISTOR 2SB709A-QRS-TX		R007	1-216-833-11	RES-CHIP	10K 5% 1/10W
Q110	8-729-424-02	TRANSISTOR 2SB709A-QRS-TX (KV-27FS200/32FS200 ONLY)		R009	1-216-864-11	SHORT CHIP	0
				R010	1-249-409-11	CARBON	220 5% 1/4W
				R011	1-216-821-11	RES-CHIP	1K 5% 1/10W
				R012	1-216-827-11	RES-CHIP	3.3K 5% 1/10W
				R013	1-218-867-11	RES-CHIP	6.8K 5% 1/10W



NOTE: The components identified by shading and  mark are critical for safety. Replace only with part number specified.

NOTE: Les composants identifiés par un trame et une  sont critiques pour la sécurité. Ne les remplacer que par une pièce portant le numéro spécifique.



REF. NO.	PART NO.	DESCRIPTION	VALUES			REF. NO.	PART NO.	DESCRIPTION	VALUES		
R015	1-216-813-11	RES-CHIP	220	5%	1/10W	R075	1-216-813-11	RES-CHIP	220	5%	1/10W
R016	1-216-813-11	RES-CHIP	220	5%	1/10W	R076	1-216-841-11	RES-CHIP	47K	5%	1/10W
R017	1-216-813-11	RES-CHIP	220	5%	1/10W	R077	1-216-809-11	RES-CHIP	100	5%	1/10W
R018	1-216-813-11	RES-CHIP	220	5%	1/10W	R078	1-216-841-11	RES-CHIP	47K	5%	1/10W
R019	1-216-829-11	RES-CHIP	4.7K	5%	1/10W	 R080	1-216-829-11	RES-CHIP	4.7K	5%	1/10W
R020	1-218-688-11	METAL CHIP	680	0.50%	1/16W	R085	1-215-924-00	METAL OXIDE	15K	5%	3W
R021	1-216-829-11	RES-CHIP	4.7K	5%	1/10W	R086	1-216-839-11	RES-CHIP	33K	5%	1/10W
R022	1-218-688-11	METAL CHIP	680	0.50%	1/16W	R087	1-216-837-11	RES-CHIP	22K	5%	1/10W
R023	1-216-829-11	RES-CHIP	4.7K	5%	1/10W	R089	1-216-829-11	RES-CHIP	4.7K	5%	1/10W
R024	1-218-688-11	METAL CHIP	680	0.50%	1/16W	R098	1-216-821-11	RES-CHIP	1K	5%	1/10W
R025	1-216-813-11	RES-CHIP	220	5%	1/10W	R099	1-216-809-11	RES-CHIP	100	5%	1/10W
R027	1-216-813-11	RES-CHIP	220	5%	1/10W	R101	1-216-829-11	RES-CHIP	4.7K	5%	1/10W
R029	1-249-409-11	CARBON	220	5%	1/4W	R102	1-216-829-11	RES-CHIP	4.7K	5%	1/10W
R030	1-216-841-11	RES-CHIP	47K	5%	1/10W	R103	1-249-425-11	CARBON	4.7K	5%	1/4W
R031	1-216-809-11	RES-CHIP	100	5%	1/10W	R107	1-216-809-11	RES-CHIP	100	5%	1/10W
		(KV-27FS200/32FS200 ONLY)				R108	1-216-809-11	RES-CHIP	100	5%	1/10W
R032	1-216-813-11	RES-CHIP	220	5%	1/10W	R110	1-247-807-31	CARBON	100	5%	1/4W
R033	1-249-417-11	CARBON	1K	5%	1/4W	R111	1-216-809-11	RES-CHIP	100	5%	1/10W
R034	1-216-813-11	RES-CHIP	220	5%	1/10W	R113	1-247-807-31	CARBON	100	5%	1/4W
R035	1-216-813-11	RES-CHIP	220	5%	1/10W	R114	1-249-409-11	CARBON	220	5%	1/4W
R037	1-216-829-11	RES-CHIP	4.7K	5%	1/10W			(KV-27FS200/32FS200 ONLY)			
R038	1-249-417-11	CARBON	1K	5%	1/4W	R117	1-216-837-11	RES-CHIP	22K	5%	1/10W
R039	1-216-829-11	RES-CHIP	4.7K	5%	1/10W			(KV-27FS200/32FS200 ONLY)			
R048	1-216-829-11	RES-CHIP	4.7K	5%	1/10W	R118	1-216-837-11	RES-CHIP	22K	5%	1/10W
R050	1-216-833-11	RES-CHIP	10K	5%	1/10W			(KV-27FS200/32FS200 ONLY)			
R051	1-216-857-11	RES-CHIP	1M	5%	1/10W	R120	1-249-413-11	CARBON	470	5%	1/4W
R052	1-216-845-11	RES-CHIP	100K	5%	1/10W	R131	1-216-813-11	RES-CHIP	220	5%	1/10W
R053	1-216-821-11	RES-CHIP	1K	5%	1/10W			(KV-27FS200/32FS200 ONLY)			
R054	1-249-417-11	CARBON	1K	5%	1/4W	R132	1-216-829-11	RES-CHIP	4.7K	5%	1/10W
R055	1-216-841-11	RES-CHIP	47K	5%	1/10W			(KV-27FS200/32FS200 ONLY)			
R056	1-216-813-11	RES-CHIP	220	5%	1/10W	R133	1-216-841-11	RES-CHIP	47K	5%	1/10W
R057	1-216-845-11	RES-CHIP	100K	5%	1/10W	R134	1-216-813-11	RES-CHIP	220	5%	1/10W
R058	1-216-845-11	RES-CHIP	100K	5%	1/10W	R135	1-216-813-11	RES-CHIP	220	5%	1/10W
R060	1-249-409-11	CARBON	220	5%	1/4W	R136	1-249-425-11	CARBON	4.7K	5%	1/4W
R061	1-249-437-11	CARBON	47K	5%	1/4W	R137	1-216-829-11	RES-CHIP	4.7K	5%	1/10W
 R063	1-216-829-11	RES-CHIP	4.7K	5%	1/10W	R139	1-216-813-11	RES-CHIP	220	5%	1/10W
								(KV-27FS200/32FS200 ONLY)			
R064	1-216-813-11	RES-CHIP	220	5%	1/10W	R140	1-249-409-11	CARBON	220	5%	1/4W
R065	1-216-841-11	RES-CHIP	47K	5%	1/10W	R145	1-249-401-11	CARBON	47	5%	1/4W
R066	1-249-429-11	CARBON	10K	5%	1/4W	R201	1-216-864-11	SHORT CHIP	0		
R068	1-216-833-11	RES-CHIP	10K	5%	1/10W	R202	1-249-409-11	CARBON	220	5%	1/4W
R070	1-216-813-11	RES-CHIP	220	5%	1/10W	R206	1-249-409-11	CARBON	220	5%	1/4W
R071	1-216-841-11	RES-CHIP	47K	5%	1/10W	R207	1-216-845-11	RES-CHIP	100K	5%	1/10W
R073	1-249-425-11	CARBON	4.7K	5%	1/4W	R208	1-249-409-11	CARBON	220	5%	1/4W
R074	1-249-417-11	CARBON	1K	5%	1/4W						



























REF. NO.	PART NO.	DESCRIPTION	VALUES			REF. NO.	PART NO.	DESCRIPTION	VALUES		
R209	1-216-845-11	RES-CHIP	100K	5%	1/10W	R339	1-216-849-11	RES-CHIP	220K	5%	1/10W
R210	1-216-813-11	RES-CHIP	220	5%	1/10W	R340	1-216-861-11	RES-CHIP	2.2M	5%	1/10W
R217	1-216-845-11	RES-CHIP	100K	5%	1/10W			(KV-27FS100/27FS200/29FS100(N)(S) ONLY)			
R218	1-216-845-11	RES-CHIP	100K	5%	1/10W	R340	1-216-863-11	RES-CHIP	3.3M	5%	1/10W
R219	1-216-813-11	RES-CHIP	220	5%	1/10W			(KV-32FS100/32FS200/34FS100(N)(S) ONLY)			
R220	1-216-813-11	RES-CHIP	220	5%	1/10W	R341	1-216-842-11	RES-CHIP	56K	5%	1/10W
R222	1-216-845-11	RES-CHIP	100K	5%	1/10W			(KV-27FS100/27FS200/29FS100(N)(S) ONLY)			
R223	1-216-813-11	RES-CHIP	220	5%	1/10W	R341	1-216-851-11	RES-CHIP	330K	5%	1/10W
R224	1-249-409-11	CARBON	220	5%	1/4W			(KV-32FS100/32FS200/34FS100(N)(S) ONLY)			
R225	1-216-845-11	RES-CHIP	100K	5%	1/10W	R342	1-216-839-11	RES-CHIP	33K	5%	1/10W
R232	1-216-853-11	RES-CHIP	470K	5%	1/10W	R343	1-216-833-11	RES-CHIP	10K	5%	1/10W
R233	1-216-853-11	RES-CHIP	470K	5%	1/10W	R344	1-216-853-11	RES-CHIP	470K	5%	1/10W
R234	1-216-813-11	RES-CHIP	220	5%	1/10W	R345	1-216-845-11	RES-CHIP	100K	5%	1/10W
R235	1-216-813-11	RES-CHIP	220	5%	1/10W	R346	1-216-845-11	RES-CHIP	100K	5%	1/10W
R300	1-113-619-11	CERAMIC CHIP	0.47 $\mu$ F		10V	R347	1-216-825-11	RES-CHIP	2.2K	5%	1/10W
R301	1-216-809-11	RES-CHIP	100	5%	1/10W	R348	1-216-825-11	RES-CHIP	2.2K	5%	1/10W
R302	1-216-817-11	RES-CHIP	470	5%	1/10W	R349	1-216-864-11	SHORT CHIP	0		
R303	1-216-818-11	RES-CHIP	560	5%	1/10W	R350	1-216-825-11	RES-CHIP	2.2K	5%	1/10W
R306	1-216-843-11	RES-CHIP	68K	5%	1/10W	R351	1-216-864-11	SHORT CHIP	0		
R308	1-249-429-11	CARBON	10K	5%	1/4W	R352	1-216-864-11	SHORT CHIP	0		
R311	1-216-821-11	RES-CHIP	1K	5%	1/10W	R356	1-247-807-31	CARBON	100	5%	1/4W
R314	1-216-825-11	RES-CHIP	2.2K	5%	1/10W	R359	1-216-833-11	RES-CHIP	10K	5%	1/10W
R315	1-216-809-11	RES-CHIP	100	5%	1/10W	R365	1-216-818-11	RES-CHIP	560	5%	1/10W
R316	1-216-830-11	RES-CHIP	5.6K	5%	1/10W	R367	1-247-807-31	CARBON	100	5%	1/4W
R317	1-216-818-11	RES-CHIP	560	5%	1/10W	R368	1-216-864-11	SHORT CHIP	0		
R318	1-216-864-11	SHORT CHIP	0			R369	1-216-809-11	RES-CHIP	100	5%	1/10W
R319	1-216-809-11	RES-CHIP	100	5%	1/10W	R370	1-216-809-11	RES-CHIP	100	5%	1/10W
R320	1-216-864-11	SHORT CHIP	0			R372	1-216-864-11	SHORT CHIP	0		
R321	1-247-807-31	CARBON	100	5%	1/4W	R374	1-216-833-11	RES-CHIP	10K	5%	1/10W
R322	1-216-829-11	RES-CHIP	4.7K	5%	1/10W	R376	1-216-809-11	RES-CHIP	100	5%	1/10W
R323	1-216-818-11	RES-CHIP	560	5%	1/10W	R378	1-216-809-11	RES-CHIP	100	5%	1/10W
R325	1-247-807-31	CARBON	100	5%	1/4W	R379	1-216-809-11	RES-CHIP	100	5%	1/10W
R328	1-216-833-11	RES-CHIP	10K	5%	1/10W	R380	1-216-809-11	RES-CHIP	100	5%	1/10W
R329	1-216-809-11	RES-CHIP	100	5%	1/10W	R381	1-216-821-11	RES-CHIP	1K	5%	1/10W
		(KV-27FS200/32FS200 ONLY)				R382	1-218-867-11	RES-CHIP	6.8K	5%	1/10W
R330	1-216-815-11	RES-CHIP	330	5%	1/10W	R383	1-249-421-11	CARBON	2.2K	5%	1/4W
R331	1-218-716-11	METAL CHIP	10K	0.50%	1/16W	R384	1-216-840-11	RES-CHIP	39K	5%	1/10W
R332	1-216-809-11	RES-CHIP	100	5%	1/10W	R386	1-216-845-11	RES-CHIP	100K	5%	1/10W
R333	1-216-809-11	RES-CHIP	100	5%	1/10W	R387	1-216-864-11	SHORT CHIP	0		
R334	1-216-821-11	RES-CHIP	1K	5%	1/10W	R388	1-216-821-11	RES-CHIP	1K	5%	1/10W
R335	1-216-821-11	RES-CHIP	1K	5%	1/10W	R389	1-216-864-11	SHORT CHIP	0		
R336	1-216-809-11	RES-CHIP	100	5%	1/10W	R390	1-218-285-11	RES-CHIP	75	5%	1/10W
R337	1-249-417-11	CARBON	1K	5%	1/4W	R391	1-218-285-11	RES-CHIP	75	5%	1/10W
R338	1-216-809-11	RES-CHIP	100	5%	1/10W	R393	1-218-285-11	RES-CHIP	75	5%	1/10W

NOTE: The components identified by shading and  mark are critical for safety. Replace only with part number specified.

A component identified by this  symbol indicates that it has been carefully factory-selected to satisfy regulations regarding X-ray radiation. Should replacement be required, replace only with the value originally used.



REF. NO.	PART NO.	DESCRIPTION	VALUES			REF. NO.	PART NO.	DESCRIPTION	VALUES			
R394	1-218-285-11	RES-CHIP	75	5%	1/10W	 R523	1-216-837-11	RES-CHIP	22K	5%	1/10W	
R401	1-216-809-11	RES-CHIP	100	5%	1/10W			(KV-27FS100/27FS200/29FS100(N)(S) ONLY)				
R403	1-216-809-11	RES-CHIP	100	5%	1/10W	 R524	1-249-429-11	CARBON	10K	5%	1/4W	
R405	1-216-825-11	RES-CHIP	2.2K	5%	1/10W	 R525	1-249-428-11	CARBON	8.2K	5%	1/4W	
R408	1-216-825-11	RES-CHIP	2.2K	5%	1/10W		R526	1-215-905-11	METAL OXIDE	10	5%	3W
								(KV-32FS100/32FS200/34FS100(N)(S) ONLY)				
R409	1-249-407-11	CARBON	150	5%	1/4W		R526	1-216-377-11	METAL OXIDE	4.7	5%	2W
R411	1-216-817-11	RES-CHIP	470	5%	1/10W			(KV-27FS100/27FS200/29FS100(N)(S) ONLY)				
R412	1-216-821-11	RES-CHIP	1K	5%	1/10W	 R528	1-216-837-11	RES-CHIP	22K	5%	1/10W	
R413	1-216-833-11	RES-CHIP	10K	5%	1/10W	 R529	1-218-724-11	METAL CHIP	22K	0.50%	1/16W	
R414	1-216-864-11	SHORT CHIP	0			  R530	1-218-718-11	METAL CHIP	12K	0.50%	1/16W	
R415	1-216-864-11	SHORT CHIP	0									
R416	1-216-829-11	RES-CHIP	4.7K	5%	1/10W	  R531	1-218-734-11	METAL CHIP	56K	0.50%	1/16W	
R452	1-249-409-11	CARBON	220	5%	1/4W			(KV-32FS100/32FS200/34FS100(N)(S) ONLY)				
R453	1-216-813-11	RES-CHIP	220	5%	1/10W	  R531	1-218-746-11	METAL CHIP	180K	0.50%	1/16W	
		(KV-27FS200/32FS200 ONLY)						(KV-27FS100/27FS200/29FS100(N)(S) ONLY)				
		(KV-27FS200/32FS200 ONLY)				 R532	1-216-810-11	RES-CHIP	120	5%	1/10W	
R501	1-216-815-11	RES-CHIP	330	5%	1/10W		R533	1-215-879-11	METAL OXIDE	47K	5%	1W
		(KV-27FS100/27FS200/29FS100(N)(S) ONLY)					R535	1-216-855-11	RES-CHIP	680K	5%	1/10W
R501	1-216-817-11	RES-CHIP	470	5%	1/10W	 R536	1-260-288-11	CARBON	0.47	5%	1/2W	
		(KV-32FS100/32FS200/34FS100(N)(S) ONLY)				 R537	1-260-288-11	CARBON	0.47	5%	1/2W	
R502	1-216-829-11	RES-CHIP	4.7K	5%	1/10W		R538	1-247-887-00	CARBON	220K	5%	1/4W
 R503	1-249-425-11	CARBON	4.7K	5%	1/4W		R541	1-215-922-11	METAL OXIDE	6.8K	5%	3W
R504	1-215-885-00	METAL OXIDE	68	5%	2W		R542	1-216-486-00	METAL OXIDE	8.2K	5%	3W
		(KV-27FS100/27FS200/29FS100(N)(S) ONLY)				 R543	1-249-377-11	CARBON	0.47	5%	1/4W	
R504	1-216-455-21	METAL OXIDE	560	5%	2W	 R545	1-249-387-11	CARBON	3.3	5%	1/4W	
		(KV-32FS100/32FS200/34FS100(N)(S) ONLY)					R546	1-215-453-00	METAL	22K	1%	1/4W
R505	1-249-433-11	CARBON	22K	5%	1/4W			(KV-32FS100/32FS200/34FS100(N)(S) ONLY)				
R506	1-215-861-00	METAL OXIDE	47	5%	1W		R546	1-215-457-00	METAL	33K	1%	1/4W
R507	1-249-401-11	CARBON	47	5%	1/4W			(KV-27FS100/27FS200/29FS100(N)(S) ONLY)				
R508	1-249-425-11	CARBON	4.7K	5%	1/4W		R547	1-215-457-00	METAL	33K	1%	1/4W
 R509	1-260-328-11	CARBON	1K	5%	1/2W		R548	1-216-486-00	METAL OXIDE	8.2K	5%	3W
							R549	1-215-437-00	METAL	4.7K	1%	1/4W
 R510	1-215-883-11	METAL OXIDE	33	5%	2W	 R550	1-249-377-11	CARBON	0.47	5%	1/4W	
R512	1-215-910-00	METAL OXIDE	68	5%	3W		R551	1-215-873-00	METAL OXIDE	4.7K	5%	1W
R515	1-216-837-11	RES-CHIP	22K	5%	1/10W	 R553	1-249-377-11	CARBON	0.47	5%	1/4W	
 R516	1-216-828-11	RES-CHIP	3.9K	5%	1/10W		R554	1-215-876-00	METAL OXIDE	15K	5%	1W
		(KV-32FS100/32FS200/34FS100(N)(S) ONLY)						(KV-27FS100/27FS200/29FS100(N)(S) ONLY)				
 R516	1-216-830-11	RES-CHIP	5.6K	5%	1/10W		R554	1-215-894-11	METAL OXIDE	2.2K	5%	2W
		(KV-27FS100/27FS200/29FS100(N)(S) ONLY)						(KV-32FS100/32FS200/34FS100(N)(S) ONLY)				
R517	1-249-417-11	CARBON	1K	5%	1/4W		R555	1-249-441-11	CARBON	100K	5%	1/4W
R518	1-216-833-11	RES-CHIP	10K	5%	1/10W		R556	1-249-441-11	CARBON	100K	5%	1/4W
R519	1-249-413-11	CARBON	470	5%	1/4W		R557	1-249-441-11	CARBON	100K	5%	1/4W
R520	1-215-907-11	METAL OXIDE	22	5%	3W							
 R523	1-216-834-11	RES-CHIP	12K	5%	1/10W		R559	1-216-805-11	RES-CHIP	47	5%	1/10W
		(KV-32FS100/32FS200/34FS100(N)(S) ONLY)					R560	1-215-922-11	METAL OXIDE	6.8K	5%	3W







NOTE: The components identified by shading and  mark are critical for safety. Replace only with part number specified.

NOTE: Les composants identifiés par un trame et une marque  sont critiques pour la sécurité. Ne les remplacer que par une pièce portant le numéro spécifique.



REF. NO.	PART NO.	DESCRIPTION	VALUES	REF. NO.	PART NO.	DESCRIPTION	VALUES	
<b>TUNER</b>				<b>COIL</b>				
	TU001	8-598-593-40	TUNER, FSS BTF-WA421 (CRITICAL ON ALL EXCEPT KV-27FS200/32FS200)	L701	1-408-613-31	INDUCTOR	68μH	
	TU001	8-598-593-40	TUNER, FSS BTF-WA421 (NOT CRITICAL ON KV-27FS200/32FS200 ONLY)	<b>TRANSISTOR</b>				
<b>CRYSTAL</b>				Q700	8-729-422-27	TRANSISTOR 2SD601A-QRS-TX		
X001	1-781-931-11	VIBRATOR, CRYSTAL		Q701	8-729-422-27	TRANSISTOR 2SD601A-QRS-TX		
X301	1-567-505-11	OSCILLATOR, CRYSTAL		Q703	8-729-422-27	TRANSISTOR 2SD601A-QRS-TX		
	<b>*A-1400-455-A C (COM) BOARD, MOUNTED</b>			<b>RESISTOR</b>				
	4-382-854-11	SCREW (M3X10), P, SW (+)		R700	1-249-433-11	CARBON	22K 5% 1/4W	
<b>CAPACITOR</b>				R701	1-216-833-11	RES-CHIP	10K 5% 1/10W	
C701	1-126-947-11	ELECT	47μF 20% 25V	R702	1-216-813-11	RES-CHIP	220 5% 1/10W	
C702	1-136-165-00	FILM	0.1μF 5% 50V	R703	1-216-809-11	RES-CHIP	100 5% 1/10W	
C703	1-126-947-11	ELECT	47μF 20% 25V	R704	1-249-426-11	CARBON	5.6K 5% 1/4W	
C704	1-107-652-11	ELECT	10μF 20% 250V	R705	1-249-429-11	CARBON	10K 5% 1/4W	
C705	1-107-652-11	ELECT	10μF 20% 250V	R706	1-249-381-11	CARBON	1 5% 1/4W	
C706	1-137-528-11	MYLAR	0.1μF 10% 250V		R707	1-249-383-11	CARBON	1.5 5% 1/4W
C707	1-162-114-00	CERAMIC	0.0047μF 2KV	R708	1-247-807-31	CARBON	100 5% 1/4W	
C708	1-136-165-00	FILM	0.1μF 5% 50V	R709	1-247-807-31	CARBON	100 5% 1/4W	
C709	1-126-964-11	ELECT	10μF 20% 50V	R710	1-247-807-31	CARBON	100 5% 1/4W	
C710	1-126-964-11	ELECT	10μF 20% 50V	R711	1-260-328-11	CARBON	1K 5% 1/2W	
C711	1-102-074-00	CERAMIC	0.001μF 10% 50V	R712	1-260-328-11	CARBON	1K 5% 1/2W	
C713	1-126-964-11	ELECT	10μF 20% 50V	R713	1-260-328-11	CARBON	1K 5% 1/2W	
C714	1-126-947-11	ELECT	47μF 20% 25V	R714	1-260-087-11	CARBON	100 5% 1/2W	
<b>CONNECTOR</b>				R715	1-260-132-11	CARBON	560K 5% 1/2W	
*	CN701	1-564-506-11	PLUG,CONNECTOR 3P	R716	1-260-123-11	CARBON	100K 5% 1/2W	
	CN702	1-695-915-11	TAB (CONTACT)	R718	1-216-373-11	METAL OXIDE	2.2 5% 2W	
	CN704	1-785-879-11	CONNECTOR, ONE TOUCH	R719	1-215-888-00	METAL OXIDE	220 5% 2W	
*	CN705	1-564-511-11	PLUG,CONNECTOR 8P	R720	1-216-825-11	RES-CHIP	2.2K 5% 1/10W	
*	CN706	1-564-510-11	PLUG,CONNECTOR 7P	R721	1-216-825-11	RES-CHIP	2.2K 5% 1/10W	
<b>DIODE</b>				R722	1-247-807-31	CARBON	100 5% 1/4W	
D701	8-719-901-83	DIODE 1SS83TD		R723	1-247-807-31	CARBON	100 5% 1/4W	
D702	8-719-901-83	DIODE 1SS83TD		R724	1-247-807-31	CARBON	100 5% 1/4W	
D703	8-719-901-83	DIODE 1SS83TD		R725	1-216-825-11	RES-CHIP	2.2K 5% 1/10W	
D704	8-719-302-43	DIODE RGP10GPKG23		R726	1-216-829-11	RES-CHIP	4.7K 5% 1/10W	
<b>IC</b>				R727	1-216-825-11	RES-CHIP	2.2K 5% 1/10W	
IC701	8-759-803-42	IC LA6500-FA		<b>VARIABLE RESISTOR</b>				
IC702	8-759-562-43	IC TDA6108JF/N1B		RV701	1-241-656-11	RES, ADJ, METAL FILM	110M	
IC703	8-759-701-59	IC NJM78M09FA		RV702	1-238-019-11	RES, ADJ, CARBON	47K	



REF. NO.	PART NO.	DESCRIPTION	VALUES			REF. NO.	PART NO.	DESCRIPTION	VALUES		
<b>P</b>	<b>*A-1400-456-A</b>	<b>P (VAR) BOARD, MOUNTED (KV-27FS200/32FS200 ONLY)</b>				C3336	1-162-970-11	CERAMIC CHIP	0.01μF	10%	25V
	4-382-854-11	SCREW (M3X10), P, SW (+)				C3337	1-164-360-11	CERAMIC CHIP	0.1μF		16V
<b>CAPACITOR</b>						C3338	1-164-360-11	CERAMIC CHIP	0.1μF		16V
C100	1-126-968-11	ELECT	100μF	20%	50V	C3339	1-126-965-91	ELECT	22μF	20%	50V
C102	1-126-947-11	ELECT	47μF	20%	25V	C3340	1-126-947-11	ELECT	47μF	20%	16V
C103	1-126-964-11	ELECT	10μF	20%	50V	C3341	1-162-970-11	CERAMIC CHIP	0.01μF	10%	25V
C104	1-126-967-11	ELECT	47μF	20%	50V	C3343	1-126-947-11	ELECT	47μF	20%	25V
C106	1-162-968-11	CERAMIC CHIP	0.0047μF	10%	50V	C3390	1-104-665-11	ELECT	100μF	20%	25V
C107	1-126-960-11	ELECT	1μF	20%	50V	C3391	1-104-665-11	ELECT	100μF	20%	25V
C109	1-164-230-11	CERAMIC CHIP	220pF	5%	50V	<b>CONNECTOR</b>					
C110	1-165-176-11	CERAMIC CHIP	0.047μF	10%	16V	* CN3302	1-691-632-21	CONNECTOR, BOARD TO BOARD 15P			
C111	1-126-960-11	ELECT	1μF	20%	50V	* CN3303	1-691-632-21	CONNECTOR, BOARD TO BOARD 15P			
C3300	1-115-156-11	CERAMIC CHIP	1μF		10V	CN6600	1-695-915-11	TAB (CONTACT)			
C3301	1-115-156-11	CERAMIC CHIP	1μF		10V	<b>DIODE</b>					
C3302	1-115-156-11	CERAMIC CHIP	1μF		10V	D103	8-719-404-50	DIODE MA111-TX			
C3303	1-126-947-11	ELECT	47μF	20%	16V	D104	8-719-404-50	DIODE MA111-TX			
C3304	1-164-315-11	CERAMIC CHIP	470pF	5%	50V	D3301	8-719-404-50	DIODE MA111-TX			
C3305	1-164-360-11	CERAMIC CHIP	0.1μF		16V	D3304	8-719-109-72	DIODE MTZJ-T-77-3.9B			
C3308	1-126-947-11	ELECT	47μF	20%	16V	<b>IC</b>					
C3312	1-164-315-11	CERAMIC CHIP	470pF	5%	50V	IC3301	6-701-754-01	IC M65665ASP			
C3313	1-162-927-11	CERAMIC CHIP	100pF	5%	50V	IC3390	8-759-701-59	IC NJM78M09FA			
C3316	1-126-947-11	ELECT	47μF	20%	16V	<b>CHIP CONDUCTOR</b>					
C3317	1-162-970-11	CERAMIC CHIP	0.01μF	10%	25V	JR001	1-216-864-11	SHORT CHIP	0		
C3318	1-162-970-11	CERAMIC CHIP	0.01μF	10%	25V	JR002	1-216-864-11	SHORT CHIP	0		
C3319	1-126-947-11	ELECT	47μF	20%	16V	<b>COIL</b>					
C3320	1-162-970-11	CERAMIC CHIP	0.01μF	10%	25V	L150	1-414-857-11	INDUCTOR	100μH		
C3321	1-113-619-11	CERAMIC CHIP	0.47μF		10V	L3300	1-412-058-11	INDUCTOR	10μH		
C3322	1-164-373-11	CERAMIC CHIP	0.033μF		25V	L3301	1-410-682-31	INDUCTOR	470μH		
C3323	1-127-715-91	CERAMIC CHIP	0.22μF	10%	16V	L3302	1-412-058-11	INDUCTOR	10μH		
C3324	1-162-918-11	CERAMIC CHIP	18pF	5%	50V	L3303	1-412-058-11	INDUCTOR	10μH		
C3327	1-164-315-11	CERAMIC CHIP	470pF	5%	50V	L3390	1-412-525-31	INDUCTOR	10μH		
C3328	1-162-970-11	CERAMIC CHIP	0.01μF	10%	25V	<b>TRANSISTOR</b>					
C3329	1-164-315-11	CERAMIC CHIP	470pF	5%	50V	Q151	8-729-424-02	TRANSISTOR 2SB709A-QRS-TX			
C3330	1-162-970-11	CERAMIC CHIP	0.01μF	10%	25V	Q152	8-729-422-27	TRANSISTOR 2SD601A-QRS-TX			
C3331	1-162-970-11	CERAMIC CHIP	0.01μF	10%	25V	Q3300	8-729-422-27	TRANSISTOR 2SD601A-QRS-TX			
C3332	1-162-970-11	CERAMIC CHIP	0.01μF	10%	25V	Q3301	8-729-422-27	TRANSISTOR 2SD601A-QRS-TX			
C3334	1-162-970-11	CERAMIC CHIP	0.01μF	10%	25V	Q3302	8-729-422-27	TRANSISTOR 2SD601A-QRS-TX			
C3335	1-164-360-11	CERAMIC CHIP	0.1μF		16V	Q3304	8-729-926-14	TRANSISTOR 2SD1292			
						Q3305	8-729-422-27	TRANSISTOR 2SD601A-QRS-TX			



REF. NO.	PART NO.	DESCRIPTION	VALUES			REF. NO.	PART NO.	DESCRIPTION	VALUES		
Q3307	8-729-424-02	TRANSISTOR 2SB709A-QRS-TX				R3329	1-216-864-11	SHORT CHIP	0		
Q3308	8-729-424-02	TRANSISTOR 2SB709A-QRS-TX				R3330	1-216-821-11	RES-CHIP	1K	5%	1/10W
Q3309	8-729-424-02	TRANSISTOR 2SB709A-QRS-TX				R3331	1-216-821-11	RES-CHIP	1K	5%	1/10W
Q3310	8-729-422-27	TRANSISTOR 2SD601A-QRS-TX				R3335	1-215-857-71	METAL OXIDE	10	5%	1W
Q3312	8-729-422-27	TRANSISTOR 2SD601A-QRS-TX				R3336	1-216-817-11	RES-CHIP	470	5%	1/10W
<b>RESISTOR</b>						R3343	1-216-821-11	RES-CHIP	1K	5%	1/10W
R100	1-216-809-11	RES-CHIP	100	5%	1/10W	R3346	1-216-821-11	RES-CHIP	1K	5%	1/10W
R101	1-216-809-11	RES-CHIP	100	5%	1/10W	R3347	1-216-833-11	RES-CHIP	10K	5%	1/10W
R103	1-216-837-11	RES-CHIP	22K	5%	1/10W	R3348	1-216-833-11	RES-CHIP	10K	5%	1/10W
R104	1-216-839-11	RES-CHIP	33K	5%	1/10W	R3350	1-216-864-11	SHORT CHIP	0		
R105	1-216-809-11	RES-CHIP	100	5%	1/10W	R3351	1-216-813-11	RES-CHIP	220	5%	1/10W
R106	1-216-817-11	RES-CHIP	470	5%	1/10W	R3354	1-216-863-11	RES-CHIP	3.3M	5%	1/10W
R107	1-216-818-11	RES-CHIP	560	5%	1/10W	R3359	1-216-864-11	SHORT CHIP	0		
R108	1-216-825-11	RES-CHIP	2.2K	5%	1/10W	R3360	1-216-864-11	SHORT CHIP	0		
R112	1-216-825-11	RES-CHIP	2.2K	5%	1/10W	R3361	1-216-864-11	SHORT CHIP	0		
R113	1-216-845-11	RES-CHIP	100K	5%	1/10W	R3362	1-216-827-11	RES-CHIP	3.3K	5%	1/10W
R114	1-216-857-11	RES-CHIP	1M	5%	1/10W	R3363	1-216-839-11	RES-CHIP	33K	5%	1/10W
R115	1-216-833-11	RES-CHIP	10K	5%	1/10W	R3364	1-247-807-31	CARBON	100	5%	1/4W
R116	1-216-833-11	RES-CHIP	10K	5%	1/10W	R3365	1-247-807-31	CARBON	100	5%	1/4W
R117	1-216-829-11	RES-CHIP	4.7K	5%	1/10W	R3368	1-216-833-11	RES-CHIP	10K	5%	1/10W
R3300	1-216-841-11	RES-CHIP	47K	5%	1/10W	R3369	1-216-864-11	SHORT CHIP	0		
R3301	1-216-821-11	RES-CHIP	1K	5%	1/10W	R3372	1-216-864-11	SHORT CHIP	0		
R3302	1-216-841-11	RES-CHIP	47K	5%	1/10W	R3374	1-216-864-11	SHORT CHIP	0		
R3303	1-216-821-11	RES-CHIP	1K	5%	1/10W	R3390	1-216-395-00	METAL OXIDE	3.3	5%	3W
R3304	1-216-821-11	RES-CHIP	1K	5%	1/10W	<b>TUNER</b>					
R3305	1-216-841-11	RES-CHIP	47K	5%	1/10W	TU150	8-598-594-00	TUNER, FSS BTF-FA421			
R3306	1-216-837-11	RES-CHIP	22K	5%	1/10W	<b>CRYSTAL</b>					
R3307	1-216-821-11	RES-CHIP	1K	5%	1/10W	X3301	1-781-377-21	VIBRATOR, CRYSTAL			
R3308	1-216-837-11	RES-CHIP	22K	5%	1/10W	<b>HS</b>					
R3309	1-216-817-11	RES-CHIP	470	5%	1/10W	<b>*A-1401-099-A HS (VAR) BOARD, MOUNTED</b>					
R3310	1-216-841-11	RES-CHIP	47K	5%	1/10W	<b>CAPACITOR</b>					
R3311	1-216-819-11	RES-CHIP	680	5%	1/10W	C1001	1-126-935-11	ELECT	470μF	20%	16V
R3312	1-216-864-11	SHORT CHIP	0			C1002	1-164-096-11	CERAMIC	0.01μF		50V
R3313	1-216-864-11	SHORT CHIP	0			C1234	1-126-960-11	ELECT	1μF	20%	50V
R3314	1-216-864-11	SHORT CHIP	0			C1235	1-126-960-11	ELECT	1μF	20%	50V
R3318	1-216-833-11	RES-CHIP	10K	5%	1/10W	C1238	1-126-959-11	ELECT	0.47μF	20%	50V
R3319	1-216-833-11	RES-CHIP	10K	5%	1/10W	<b>CONNECTOR</b>					
R3320	1-216-829-11	RES-CHIP	4.7K	5%	1/10W	* CN1004	1-564-509-11	PLUG,CONNECTOR	6P		
R3321	1-216-864-11	SHORT CHIP	0			* CN1005	1-564-508-11	PLUG,CONNECTOR	5P		
R3323	1-249-414-11	CARBON	560	5%	1/4W	* CN1006	1-564-507-11	PLUG,CONNECTOR	4P		
R3324	1-216-821-11	RES-CHIP	1K	5%	1/10W						
R3327	1-216-864-11	SHORT CHIP	0								
R3328	1-216-821-11	RES-CHIP	1K	5%	1/10W						

NOTE: The components identified by shading and  $\triangle$  mark are critical for safety. Replace only with part number specified.

NOTE: Les composants identifiés par un trame et une marque  $\triangle$  sont critiques pour la sécurité. Ne les remplacer que par une pièce portant le numéro spécifique.



REF. NO.	PART NO.	DESCRIPTION	VALUES	REF. NO.	PART NO.	DESCRIPTION	VALUES
<b>DIODE</b>							
D1001	8-719-929-15	DIODE MTZJ-T-77-9.1B					
D1002	8-719-070-80	DIODE LNK0120022G					
D1233	8-719-929-15	DIODE MTZJ-T-77-9.1B					
D1235	8-719-929-15	DIODE MTZJ-T-77-9.1B					
D1236	8-719-929-15	DIODE MTZJ-T-77-9.1B					
<b>IC</b>							
IC1001	8-742-212-20	HYB IC SBX3081-71					
<b>JACK</b>							
J1231	1-794-048-11	JACK, PIN 3P					
<b>RESISTOR</b>							
R1004	1-249-417-11	CARBON	1K 5% 1/4W				
R1007	1-247-807-31	CARBON	100 5% 1/4W				
R1008	1-249-425-11	CARBON	4.7K 5% 1/4W				
R1009	1-249-420-11	CARBON	1.8K 5% 1/4W				
R1010	1-249-417-11	CARBON	1K 5% 1/4W				
R1011	1-249-416-11	CARBON	820 5% 1/4W				
R1201	1-249-417-11	CARBON	1K 5% 1/4W				
R1202	1-249-420-11	CARBON	1.8K 5% 1/4W				
R1203	1-249-425-11	CARBON	4.7K 5% 1/4W				
R1234	1-247-804-11	CARBON	75 5% 1/4W				
R1235	1-249-409-11	CARBON	220 5% 1/4W				
R1236	1-249-441-11	CARBON	100K 5% 1/4W				
R1237	1-249-409-11	CARBON	220 5% 1/4W				
R1238	1-249-441-11	CARBON	100K 5% 1/4W				
<b>SWITCH</b>							
S1001	1-692-431-21	SWITCH TACTILE					
S1002	1-692-431-21	SWITCH TACTILE					
S1003	1-692-431-21	SWITCH TACTILE					
S1004	1-692-431-21	SWITCH TACTILE					
S1005	1-692-431-21	SWITCH TACTILE					
S1006	1-692-431-21	SWITCH TACTILE					
S1007	1-762-816-11	SWITCH TACTILE					
S1008	1-762-816-11	SWITCH TACTILE					
				<b>CAPACITOR</b>			
				C501	1-165-529-11	MYLAR	0.22μF 10 275V
				C600	1-117-703-11	CERAMIC	0.0047μF 250V
				(KV-29FS100(S))/34FS100(S) ONLY)			
				$\triangle$ C601	1-165-529-11	MYLAR	0.22μF 10 275V
				$\triangle$ C603	1-165-529-11	MYLAR	0.22μF 10 275V
				C604	1-164-625-11	CERAMIC	680pF 10% 500V
				$\triangle$ C607	1-119-911-51	CERAMIC	470pF 10% 250V
				$\triangle$ C608	1-119-912-51	CERAMIC	1000pF 20% 250V
				C609	1-164-625-11	CERAMIC	680pF 10% 500V
				C613	1-117-214-11	CERAMIC	0.001μF 2KV
				(KV-29FS100(S))/34FS100(S) ONLY)			
				C614	1-117-214-11	CERAMIC	0.001μF 2KV
				(KV-29FS100(S))/34FS100(S) ONLY)			
				C615	1-117-214-11	CERAMIC	0.001μF 2KV
				(KV-29FS100(S))/34FS100(S) ONLY)			
				C616	1-126-943-11	ELECT	2200μF 20% 25V
				C617	1-123-024-21	ELECT	33μF 160V
				C618	1-126-943-11	ELECT	2200μF 20% 25V
				(KV-27FS200/32FS200 ONLY)			
				C619	1-117-214-11	CERAMIC	0.001μF 2KV
				(KV-29FS100(S))/34FS100(S) ONLY)			
				C620	1-162-970-11	CERAMIC CHIP	0.01μF 10% 25V
				C621	1-117-894-11	ELECT	560μF 20% 250V
				C624	1-107-636-11	ELECT	10μF 20% 160V
				C629	1-117-894-11	ELECT	560μF 20% 250V
				C632	1-126-947-11	ELECT	47μF 20% 25V
				C633	1-136-479-11	FILM	0.001μF 2% 50V
				C634	1-126-964-11	ELECT	10μF 20% 50V



NOTE: The components identified by shading and  $\triangle$  mark are critical for safety. Replace only with part number specified.

NOTE: Les composants identifiés par un triangle et une marque  $\triangle$  sont critiques pour la sécurité. Ne les remplacer que par une pièce portant le numéro spécifique.

REF. NO.	PART NO.	DESCRIPTION	VALUES	REF. NO.	PART NO.	DESCRIPTION	VALUES
C635	1-126-963-11	ELECT	4.7 $\mu$ F 20% 50V	*	CN1401	1-564-507-11	PLUG,CONNECTOR 4P
C637	1-136-165-00	FILM	0.1 $\mu$ F 5% 50V	*	CN1405	1-564-506-11	PLUG,CONNECTOR 3P
C638	1-104-665-11	ELECT	100 $\mu$ F 20% 25V	*	CN1601	1-564-509-11	PLUG,CONNECTOR 6P
C640	1-126-942-61	ELECT	1000 $\mu$ F 20% 25V				
C642	1-126-969-11	ELECT	220 $\mu$ F 20% 50V				
						<b>DIODE</b>	
C643	1-136-165-00	FILM	0.1 $\mu$ F 5% 50V	D501	8-719-404-50	DIODE MA111-TX	
C645	1-162-964-11	CERAMIC CHIP	0.001 $\mu$ F 10% 50V	D600	8-719-510-53	DIODE D4SB60L-F	
C647	1-126-947-11	ELECT	47 $\mu$ F 20% 25V	D601	8-719-511-40	DIODE S1VB20	
C648	1-104-330-91	CERAMIC	470pF 10% 1KV	D611	8-719-062-40	DIODE D4SBL20 $\mu$ F3	
C649	1-104-330-91	CERAMIC	470pF 10% 1KV	D612	8-719-068-00	DIODE ERC04-06SE (ALL EXCEPT KV-29FS100(S)/34FS100(S))	
C650	1-100-120-51	CAP,ELECT	1000 $\mu$ F				
C651	1-126-942-61	ELECT	1000 $\mu$ F 20% 25V	D613	8-719-068-00	DIODE ERC04-06SE (ALL EXCEPT KV-29FS100(S)/34FS100(S))	
C652	1-165-176-11	CERAMIC CHIP	0.047 $\mu$ F 10% 16V	D614	8-719-057-52	DIODE EZ0150AV1	
C653	1-126-960-11	ELECT	1 $\mu$ F 20% 50V	D615	8-719-062-40	DIODE D4SBL20 $\mu$ F3	
C656	1-161-964-91	CERAMIC	0.0047 $\mu$ F 250V	D618	8-719-979-64	DIODE $\mu$ F4005PKG23	
C658	1-161-964-91	CERAMIC	0.0047 $\mu$ F 250V	D620	8-719-404-50	DIODE MA111-TX	
C665	1-126-942-61	ELECT	1000 $\mu$ F 20% 25V	D621	6-500-181-01	DIODE MA6D50	
C667	1-164-625-11	CERAMIC (KV-27FS200/32FS200 ONLY)	680pF 10% 500V	D624	8-719-510-12	DIODE D10SC4M (KV-27FS200/32FS200 ONLY)	
C668	1-164-625-11	CERAMIC (KV-27FS200/32FS200 ONLY)	680pF 10% 500V	D625	8-719-510-02	DIODE D1NS4-TA2	
C669	1-164-625-11	CERAMIC	680pF 10% 500V	D628	8-719-404-50	DIODE MA111-TX	
C670	1-164-625-11	CERAMIC	680pF 10% 500V	D629	8-719-110-31	DIODE MTZJ-T-77-12C	
C672	1-165-953-11	FILM	47000pF 3% 800V	D631	8-719-063-70	DIODE D1NL20U-TA2	
C690	1-126-971-11	ELECT	470 $\mu$ F 20% 50V	D640	8-719-404-50	DIODE MA111-TX	
C1407	1-128-551-11	ELECT	22 $\mu$ F 20% 25V	D641	8-719-404-50	DIODE MA111-TX	
C1413	1-127-715-91	CERAMIC CHIP	0.22 $\mu$ F 10% 16V	D645	8-719-063-70	DIODE D1NL20U-TA2	
C1450	1-100-120-51	CAP,ELECT	1000 $\mu$ F	D646	8-719-404-50	DIODE MA111-TX	
C1451	1-113-619-11	CERAMIC CHIP	0.47 $\mu$ F 10V	D647	8-719-063-70	DIODE D1NL20U-TA2	
C1457	1-125-891-11	CERAMIC CHIP	0.47 $\mu$ F 10% 10V	D690	8-719-982-13	DIODE MTZJ-T-77-27	
C1458	1-125-891-11	CERAMIC CHIP	0.47 $\mu$ F 10% 10V	D1401	8-719-929-15	DIODE MTZJ-T-77-9.1B	
C1461	1-113-619-11	CERAMIC CHIP	0.47 $\mu$ F 10V			<b>FUSE</b>	
C1462	1-113-619-11	CERAMIC CHIP	0.47 $\mu$ F 10V	$\triangle$ F601	1-576-193-11	FUSE 6.3A/125V (ALL EXCEPT KV-29FS100(S)/34FS100(S))	
C1463	1-126-968-11	ELECT	100 $\mu$ F 20% 50V	$\triangle$ F601	1-532-506-51	FUSE 6.3A/250V (KV-29FS100(S)/34FS100(S) ONLY)	
		<b>CONNECTOR</b>					
*	CN503	1-508-765-00	PIN,CONNECTOR (5MM PITCH) 3P				
	CN600	1-580-843-11	PIN,CONNECTOR (POWER)				
*	CN602	1-564-510-11	PLUG,CONNECTOR 7P				
	CN603	1-695-915-11	TAB (CONTACT) (KV-29FS100(S)/34FS100(S) ONLY)				
	CN604	1-695-915-11	TAB (CONTACT) (ALL EXCEPT KV-29FS100(S)/34FS100(S))				
*	CN605	1-564-506-11	PLUG,CONNECTOR 3P				
						<b>FERRITE BEAD</b>	
				FB602	1-410-397-21	FERRITE 1.1 $\mu$ H	
				FB604	1-410-397-21	FERRITE 1.1 $\mu$ H	
				FB605	1-410-397-21	FERRITE 1.1 $\mu$ H	
				FB606	1-410-396-41	FERRITE 0.45 $\mu$ H	
				FB607	1-410-396-41	FERRITE 0.45 $\mu$ H	





NOTE: The components identified by shading and  $\triangle$  mark are critical for safety. Replace only with part number specified.

NOTE: Les composants identifiés par un trame et une marque  $\triangle$  sont critiques pour la sécurité. Ne les remplacer que par une pièce portant le numéro spécifique.

REF. NO.	PART NO.	DESCRIPTION	VALUES	REF. NO.	PART NO.	DESCRIPTION	VALUES
FB609	1-410-397-21	FERRITE	1.1 $\mu$ H	<b>TRANSISTOR</b>			
FB610	1-410-397-21	FERRITE	1.1 $\mu$ H	Q509	8-729-423-33	TRANSISTOR 2SC3311A-QRSTA	
FB611	1-410-397-21	FERRITE	1.1 $\mu$ H	Q600	8-729-052-32	TRANSISTOR IRFIB7N50A-LF31	
FB614	1-410-397-21	FERRITE	1.1 $\mu$ H	Q601	8-729-052-32	TRANSISTOR IRFIB7N50A-LF31	
		(KV-27FS200/32FS200 ONLY)		Q605	8-729-140-96	TRANSISTOR 2SD774-T-34	
FB616	1-410-397-21	FERRITE	1.1 $\mu$ H	Q606	8-729-422-27	TRANSISTOR 2SD601A-QRS-TX	
FB617	1-410-397-21	FERRITE	1.1 $\mu$ H	Q608	8-729-922-37	TRANSISTOR 2SD2144S-TP-UVW	
	<b>IC</b>			Q690	8-729-424-02	TRANSISTOR 2SB709A-QRS-TX	
IC600	8-759-670-30	IC MCZ3001D		Q691	8-729-424-02	TRANSISTOR 2SB709A-QRS-TX	
IC601	8-749-012-13	IC DM-58		Q1401	8-729-424-02	TRANSISTOR 2SB709A-QRS-TX	
IC605	8-759-450-47	IC BA05T		<b>RESISTOR</b>			
IC609	8-759-653-07	IC PQ09RD21		R534	1-216-833-11	RES-CHIP	10K 5% 1/10W
IC1405	8-759-573-40	IC TDA8580Q/N1		R535	1-216-825-11	RES-CHIP	2.2K 5% 1/10W
	<b>CHIP CONDUCTOR</b>			$\triangle$ R603	1-219-513-11	CARBON	4.7M 5% 1/2W
JR1	1-216-864-11	SHORT CHIP	0			(ALL EXCEPT KV-29FS100(S)/34FS100(S))	
JR2	1-216-864-11	SHORT CHIP	0	R604	1-216-833-11	RES-CHIP	10K 5% 1/10W
JR3	1-216-864-11	SHORT CHIP	0	R606	1-216-833-11	RES-CHIP	10K 5% 1/10W
JR6	1-216-864-11	SHORT CHIP	0	R607	1-216-833-11	RES-CHIP	10K 5% 1/10W
JR1402	1-216-864-11	SHORT CHIP	0	R608	1-216-833-11	RES-CHIP	10K 5% 1/10W
JR1403	1-216-864-11	SHORT CHIP	0	R609	1-205-998-11	CEMENTED	1 5% 10W
JR1406	1-216-864-11	SHORT CHIP	0	R610	1-216-833-11	RES-CHIP	10K 5% 1/10W
JR1407	1-216-864-11	SHORT CHIP	0	R611	1-216-833-11	RES-CHIP	10K 5% 1/10W
JR1409	1-216-864-11	SHORT CHIP	0	R612	1-260-131-11	RES-CHIP	470K 5% 1/2W
JR1410	1-216-864-11	SHORT CHIP	0			(KV-29FS100(S)/34FS100(S) ONLY)	
JR1411	1-216-864-11	SHORT CHIP	0	R613	1-216-833-11	RES-CHIP	10K 5% 1/10W
JR1412	1-216-864-11	SHORT CHIP	0	R614	1-216-825-11	RES-CHIP	2.2K 5% 1/10W
JR1416	1-216-864-11	SHORT CHIP	0	R615	1-202-933-61	FUSIBLE	0.1 10% 1/2W
	<b>COIL</b>			R616	1-216-822-11	RES-CHIP	1.2K 5% 1/10W
L505	1-412-529-11	INDUCTOR	22 $\mu$ H	R617	1-216-821-11	RES-CHIP	1K 5% 1/10W
L604	1-412-525-31	INDUCTOR	10 $\mu$ H	R618	1-216-864-11	SHORT CHIP	0
L605	1-412-519-11	INDUCTOR	3.3 $\mu$ H	$\triangle$ R619	1-249-377-11	CARBON	0.47 5% 1/4W
L606	1-412-519-11	INDUCTOR	3.3 $\mu$ H	R620	1-215-857-71	METAL OXIDE	10 5% 1W
L607	1-412-525-31	INDUCTOR	10 $\mu$ H	R625	1-216-817-11	RES-CHIP	470 5% 1/10W
		(KV-27FS200/32FS200 ONLY)		R626	1-218-715-11	METAL CHIP	9.1K 0.50% 1/16W
L608	1-412-529-11	INDUCTOR	22 $\mu$ H	R627	1-215-481-00	METAL	330K 1% 1/4W
	<b>PHOTO COUPLER</b>			R628	1-260-131-11	RES-CHIP	470K 5% 1/2W
$\triangle$ PH602	8-749-924-35	PHOTO COUPLER	ON3171-R			(KV-29FS100(S)/34FS100(S) ONLY)	
	<b>IC LINK</b>			R629	1-215-481-00	METAL	330K 1% 1/4W
PS601	1-576-337-21	LINK, IC		$\triangle$ R630	1-215-481-00	METAL	330K 1% 1/4W
		(KV-27FS200/32FS200 ONLY)		R631	1-218-720-11	METAL CHIP	15K 0.50% 1/16W
PS1401	1-576-337-21	LINK, IC		R632	1-218-668-11	METAL CHIP	100 0.50% 1/16W
				$\triangle$ R640	1-249-417-11	CARBON	1K 5% 1/4W
				R647	1-218-667-11	METAL CHIP	91 0.50% 1/16W







REF. NO.	PART NO.	DESCRIPTION	VALUES	REF. NO.	PART NO.	DESCRIPTION	VALUES
C909	1-161-830-00	CERAMIC	0.0047μF 500V				
C910	1-104-999-11	MYLAR	0.1μF 10% 200V				
C911	1-126-933-11	ELECT	100μF 20% 16V				
C912	1-126-941-11	ELECT	470μF 20% 25V				
C913	1-102-074-00	CERAMIC	0.001μF 10% 50V				
C914	1-130-491-00	MYLAR	0.047μF 5% 50V				
		<b>CONNECTOR</b>					
* CN902	1-770-723-11	CONNECTOR, BOARD TO BOARD 8P					
		<b>DIODE</b>					
D804	8-719-302-43	DIODE RGP10GPKG23					
D805	8-719-991-33	DIODE 1SS133T-77					
D806	8-719-991-33	DIODE 1SS133T-77					
D807	8-719-210-21	DIODE ERA82-004TP5					
D808	8-719-991-33	DIODE 1SS133T-77					
D813	8-719-991-33	DIODE 1SS133T-77					
D901	8-719-110-86	DIODE MTZJ-T-77-39					
D902	8-719-110-86	DIODE MTZJ-T-77-39					
D903	8-719-991-33	DIODE 1SS133T-77					
		<b>IC</b>					
IC801	6-701-598-01	IC UPC5023CS-184					
		<b>CHIP CONDUCTOR</b>					
JR802	1-216-864-11	SHORT CHIP	0				
		<b>COIL</b>					
L801	1-406-989-21	INDUCTOR	10MH				
L802	1-459-111-00	INDUCTOR	10MH				
L803	1-412-529-81	INDUCTOR	22μH				
L901	1-412-528-11	INDUCTOR	18μH				
		<b>TRANSISTOR</b>					
Q805	6-550-106-01	TRANSISTOR KTB764					
Q807	8-729-931-45	TRANSISTOR IRF614					
Q808	6-550-106-01	TRANSISTOR KTB764					
Q812	8-729-026-39	TRANSISTOR 2SA933AS-QRT					
Q901	8-729-045-04	TRANSISTOR 2SC5511					
Q902	8-729-045-05	TRANSISTOR 2SA2005					
Q903	8-729-422-27	TRANSISTOR 2SD601A-QRS-TX					
Q904	8-729-422-27	TRANSISTOR 2SD601A-QRS-TX					
Q905	8-729-424-02	TRANSISTOR 2SB709A-QRS-TX					
Q906	8-729-120-28	TRANSISTOR 2SC2412K-T-146-QR					
		<b>RESISTOR</b>					
R809	1-216-832-11	RES-CHIP	8.2K 5% 1/10W				
R811	1-249-393-11	CARBON	10 5% 1/4W				
R814	1-215-862-11	METAL OXIDE	68 5% 1W				
R815	1-215-862-11	METAL OXIDE	68 5% 1W				
R817	1-218-722-11	METAL CHIP	18K 0.50% 1/16W (KV-32FS100/32FS200/34FS100 ONLY)				
R817	1-218-724-11	METAL CHIP	22K 0.50% 1/16W (KV-27FS100/27FS200/29FS100 ONLY)				
R818	1-216-809-11	RES-CHIP	100 5% 1/10W				
R819	1-216-841-11	RES-CHIP	47K 5% 1/10W				
R820	1-216-837-11	RES-CHIP	22K 5% 1/10W				
R821	1-218-728-11	METAL CHIP	33K 0.50% 1/16W				
R822	1-216-841-11	RES-CHIP	47K 5% 1/10W				
R824	1-218-740-11	METAL CHIP	100K 0.50% 1/16W				
R825	1-216-845-11	RES-CHIP	100K 5% 1/10W				
R826	1-249-421-11	CARBON	2.2K 5% 1/4W				
R827	1-218-708-11	METAL CHIP	4.7K 0.50% 1/16W				
R828	1-218-728-11	METAL CHIP	33K 0.50% 1/16W				
R829	1-216-853-11	RES-CHIP	470K 5% 1/10W				
R833	1-218-710-11	METAL CHIP	5.6K 0.50% 1/16W (KV-27FS100/27FS200/29FS100 ONLY)				
R833	1-218-714-11	METAL CHIP	8.2K 0.50% 1/16W (KV-32FS100/32FS200/34FS100 ONLY)				
R834	1-218-692-11	METAL CHIP	1K 0.50% 1/16W (KV-32FS100/32FS200/34FS100 ONLY)				
R834	1-218-706-11	METAL CHIP	3.9K 0.50% 1/16W (KV-27FS100/27FS200/29FS100 ONLY)				
R840	1-218-700-11	METAL CHIP	2.2K 0.50% 1/16W				
R842	1-218-700-11	METAL CHIP	2.2K 0.50% 1/16W				
R855	1-218-720-11	METAL CHIP	15K 0.50% 1/16W (KV-27FS100/27FS200/29FS100 ONLY)				
R855	1-218-722-11	METAL CHIP	18K 0.50% 1/16W (KV-32FS100/32FS200/34FS100 ONLY)				
R856	1-218-694-11	METAL CHIP	1.2K 0.50% 1/16W (KV-32FS100/32FS200/34FS100 ONLY)				
R856	1-218-708-11	METAL CHIP	4.7K 0.50% 1/16W (KV-27FS100/27FS200/29FS100 ONLY)				
R857	1-218-716-11	METAL CHIP	10K 0.50% 1/16W				
R860	1-218-716-11	METAL CHIP	10K 0.50% 1/16W				
R864	1-218-668-11	METAL CHIP	100 0.50% 1/16W				
R866	1-249-438-11	CARBON	56K 5% 1/4W				
R870	1-216-825-11	RES-CHIP	2.2K 5% 1/10W				
R876	1-216-821-11	RES-CHIP	1K 5% 1/10W				



NOTE: The components identified by shading and mark are critical for safety. Replace only with part number specified.

NOTE: Les composants identifiés par un trame et une marque sont critiques pour la sécurité. Ne les remplacer que par une pièce portant le numéro spécifique.

REF. NO.	PART NO.	DESCRIPTION	VALUES			REF. NO.	PART NO.	DESCRIPTION	VALUES
R890	1-218-712-11	METAL CHIP	6.8K	0.50%	1/16W	<b>ACCESSORIES AND PACKING</b>			
R893	1-216-839-11	RES-CHIP	33K	5%	1/10W	4-066-845-02	BAG, PROTECTION		
R901	1-249-401-11	CARBON	47	5%	1/4W	4-088-743-01	CARTON, INDIVIDUAL (FOR KV-32FS100/32FS200/34FS100 ONLY)		
R902	1-249-386-11	CARBON	2.7	5%	1/4W	4-088-876-01	CARTON, INDIVIDUAL (FOR KV-27FS100/27FS200/29FS100 ONLY)		
R903	1-249-414-11	CARBON	560	5%	1/4W	4-088-740-01	CUSHION, UPPER (KV-32FS100/32FS200/34FS100 ONLY)		
R904	1-249-432-11	CARBON	18K	5%	1/4W	4-088-741-01	CUSHION, REAR (UPPER) (KV-32FS100/32FS200/34FS100 ONLY)		
R905	1-249-417-11	CARBON	1K	5%	1/4W	4-088-742-01	CUSHION, LOWER (KV-32FS100/32FS200/34FS100 ONLY)		
R906	1-249-432-11	CARBON	18K	5%	1/4W	4-088-874-01	CUSHION, LOWER (KV-27FS100/27FS200/29FS100 ONLY)		
R907	1-249-386-11	CARBON	2.7	5%	1/4W	4-088-875-01	CUSHION, UPPER (KV-27FS100/27FS200/29FS100 ONLY)		
R908	1-249-414-11	CARBON	560	5%	1/4W	4-089-081-21	MANUAL, INSTRUCTION (KV-27FS100/27FS200/32FS100/32FS200 ONLY)		
R909	1-260-312-11	CARBON	47	5%	1/2W	4-089-081-31	MANUAL, INSTRUCTION (KV-27FS100/32FS100 ONLY)		
R910	1-216-476-11	METAL OXIDE	180	5%	3W	4-089-081-41	MANUAL, INSTRUCTION (KV-29FS100/34FS100 ONLY)		
R911	1-249-403-11	CARBON	68	5%	1/4W	<b>REMOTE COMMANDER</b>			
R912	1-249-409-11	CARBON	220	5%	1/4W	1-476-680-21	REMOTE COMMANDER (RM-Y180) (KV-27FS100/29FS100/32FS100/34FS100 ONLY)		
R913	1-249-403-11	CARBON	68	5%	1/4W	4-978-977-11	BATTERY COVER for RM-Y180		
R914	1-249-410-11	CARBON	270	5%	1/4W	1-476-681-11	REMOTE COMMANDER (RM-Y181) (KV-27FS200/32FS200 ONLY)		
R915	1-249-417-11	CARBON	1K	5%	1/4W	4-978-977-11	BATTERY COVER for RM-Y181		
R916	1-249-417-11	CARBON	1K	5%	1/4W				
R917	1-249-417-11	CARBON	1K	5%	1/4W				
R918	1-247-807-31	CARBON	100	5%	1/4W				
R919	1-247-807-31	CARBON	100	5%	1/4W				
R920	1-249-416-11	CARBON	820	5%	1/4W				
R921	1-249-429-11	CARBON	10K	5%	1/4W				
R922	1-249-397-11	CARBON	22	5%	1/4W				
R923	1-249-401-11	CARBON	47	5%	1/4W				
R930	1-216-864-11	SHORT CHIP	0						
R934	1-216-864-11	SHORT CHIP	0						
R938	1-216-864-11	SHORT CHIP	0						

# A BOARD SCHEMATIC DIAGRAM

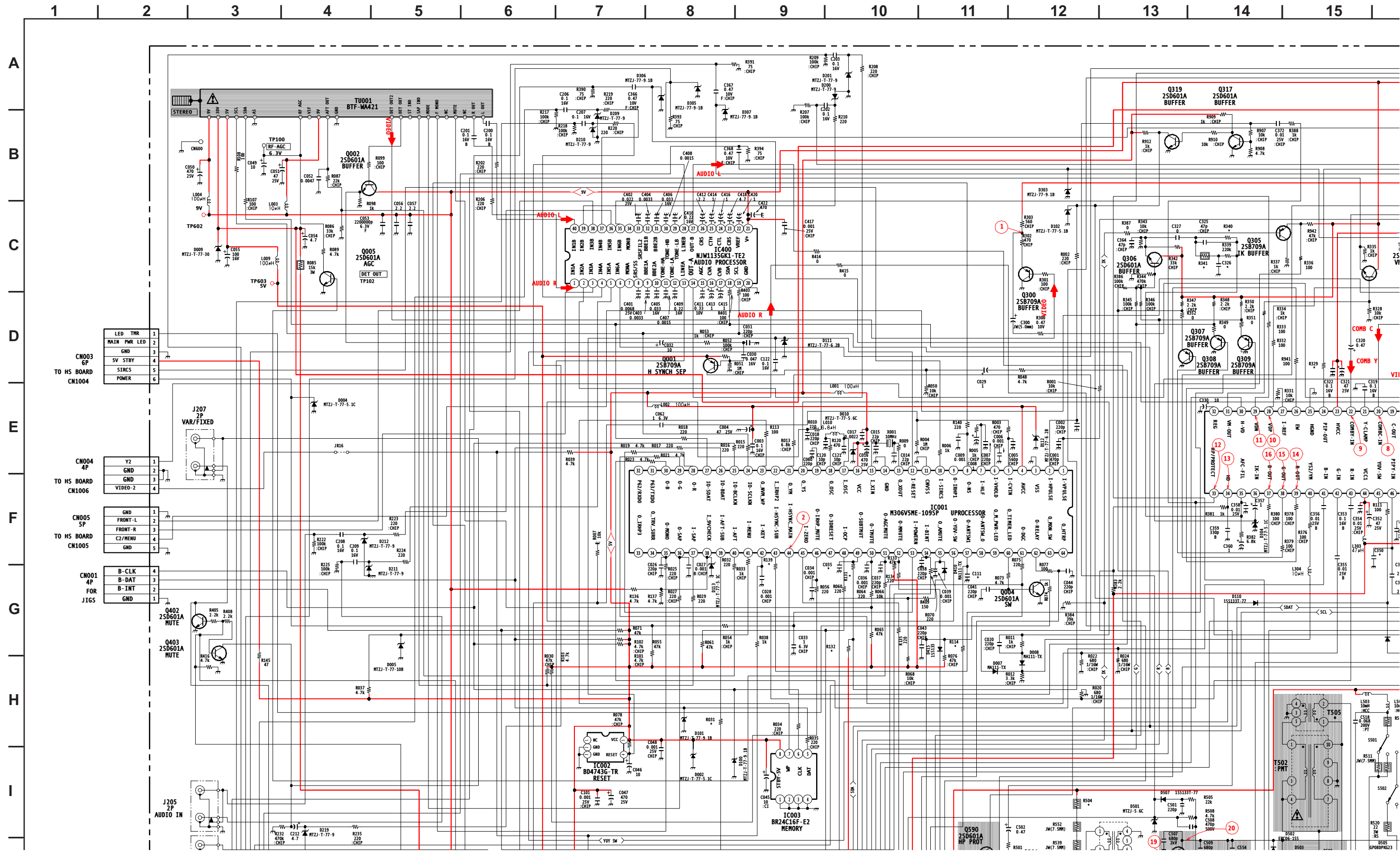

16 | 17 | 18 | 19 | 20 | 21 | 22 | 23

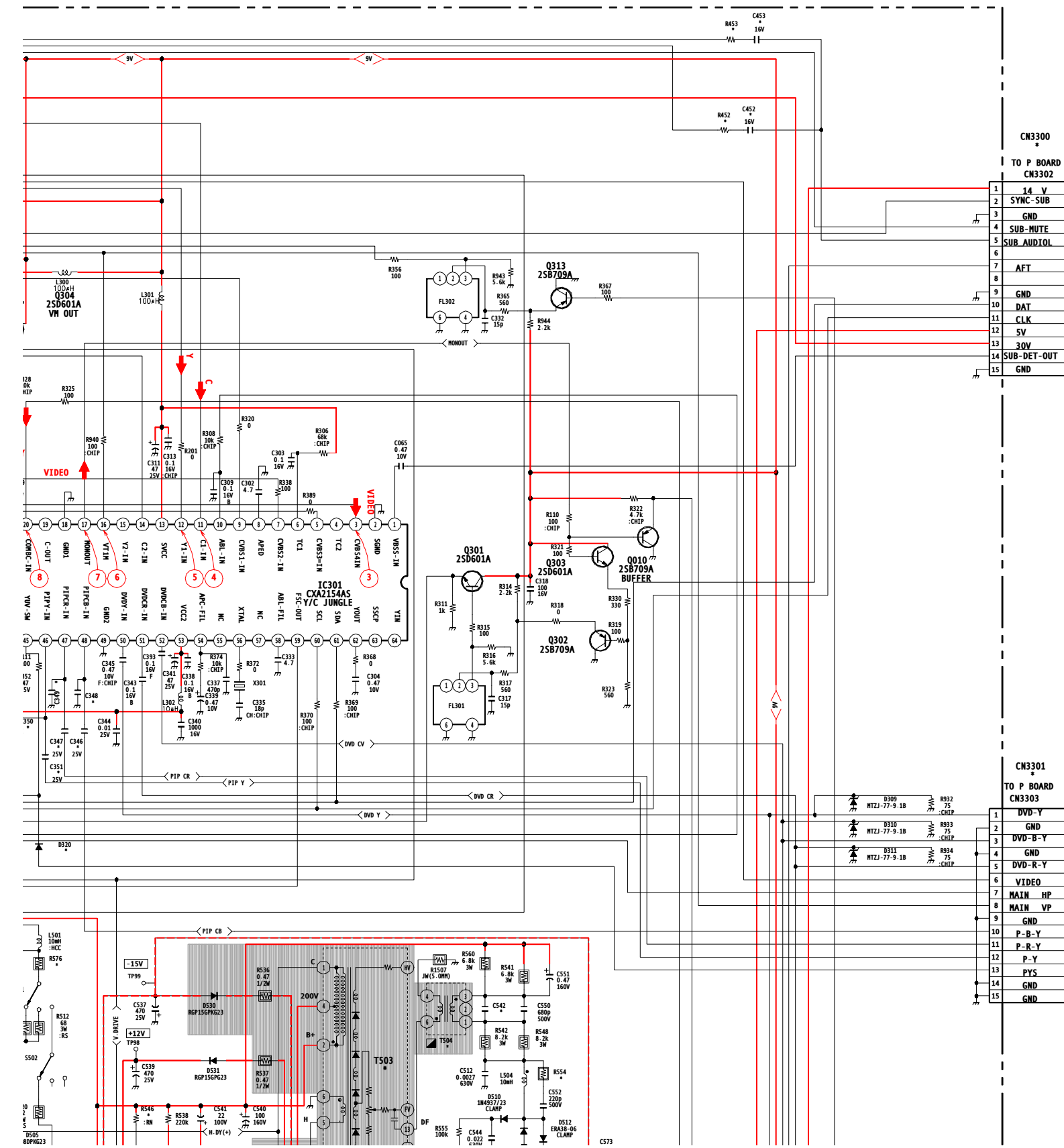

CN300  
TO P BOARD  
CN302

1	1A_V
2	SYNC-SUB
3	GND
4	SUB-MUTE
5	SUB-AUDIOL
6	
7	AFT
8	
9	GND
10	DAT
11	CLK
12	5V
13	30V
14	SUB-DET-OUT
15	GND

CN301  
TO P BOARD  
CN303

1	DVD-Y
2	GND
3	DVD-B-Y
4	GND
5	DVD-R-Y
6	VIDEO
7	MAIN_HP
8	MAIN_VP
9	GND
10	P-B-Y
11	P-R-Y
12	P-Y
13	PYS
14	GND
15	GND

J  
K  
L  
M  
N  
O  
P

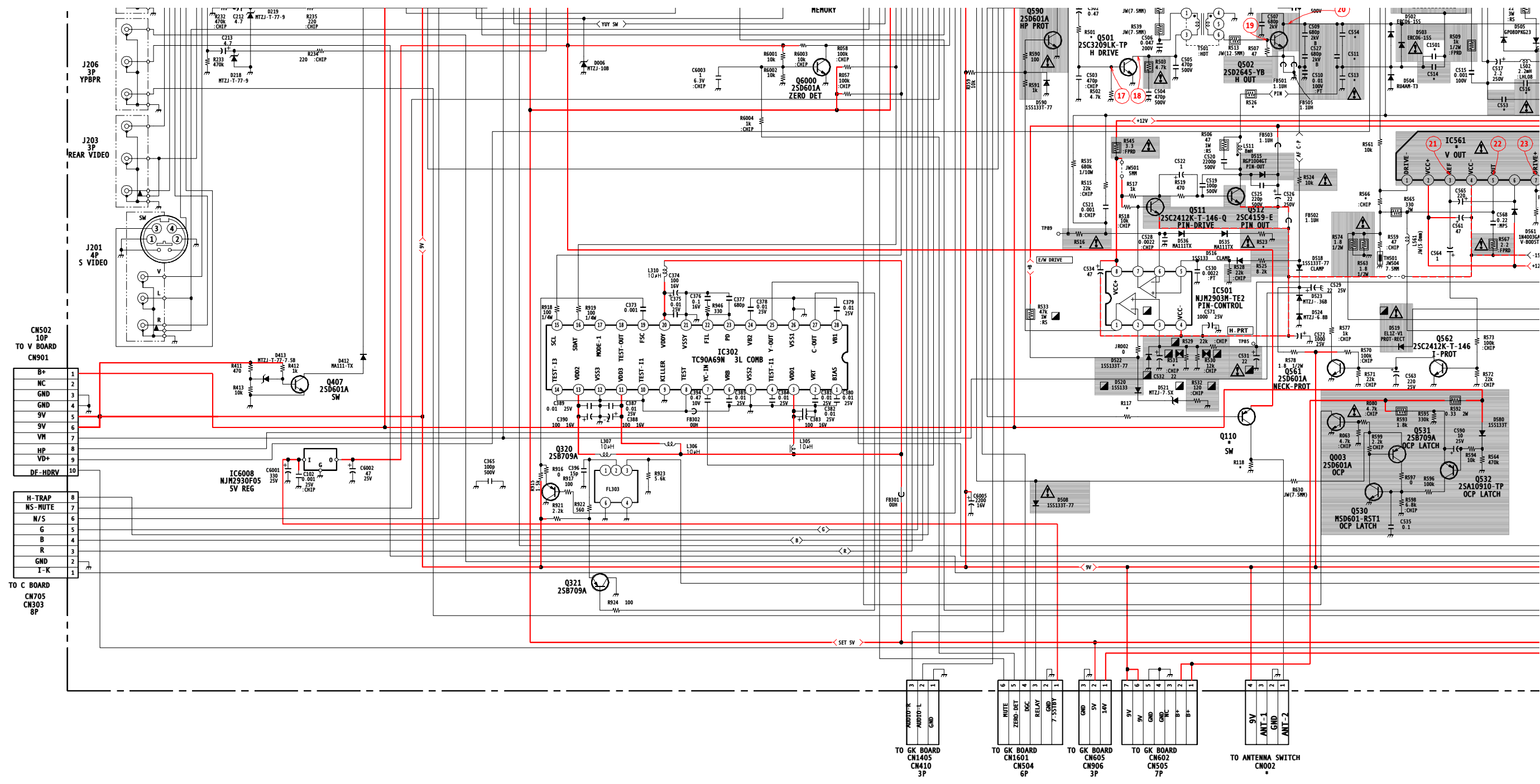

TO V BOARD  
CN901

B+	1
NC	2
GND	3
GND	4
9V	5
9V	6
VH	7
HP	8
VD+	9
DF-HDRV	10

TO C BOARD  
CN705  
CN303  
8P

H-TRAP	8
NS-MUTE	7
N/S	6
G	5
B	4
R	3
GND	2
I-K	1

TO GK BOARD  
CN1405  
CN410  
3P

ANTENNA	3
ANTENNA	2
GND	1

TO GK BOARD  
CN1601  
CN504  
6P

MUTE	6
ZERO-DET	5
REG.	4
RELAY	3
GND	2
7-SSIBY	1

TO GK BOARD  
CN605  
CN906  
3P

GND	3
5V	2
14V	1

TO GK BOARD  
CN602  
CN505  
7P

9V	7
GND	6
GND	5
GND	4
BF	3
BF	2
BF	1

TO ANTENNA SWITCH  
CN002

9V	4
ANT-1	3
GND	2
ANT-2	1

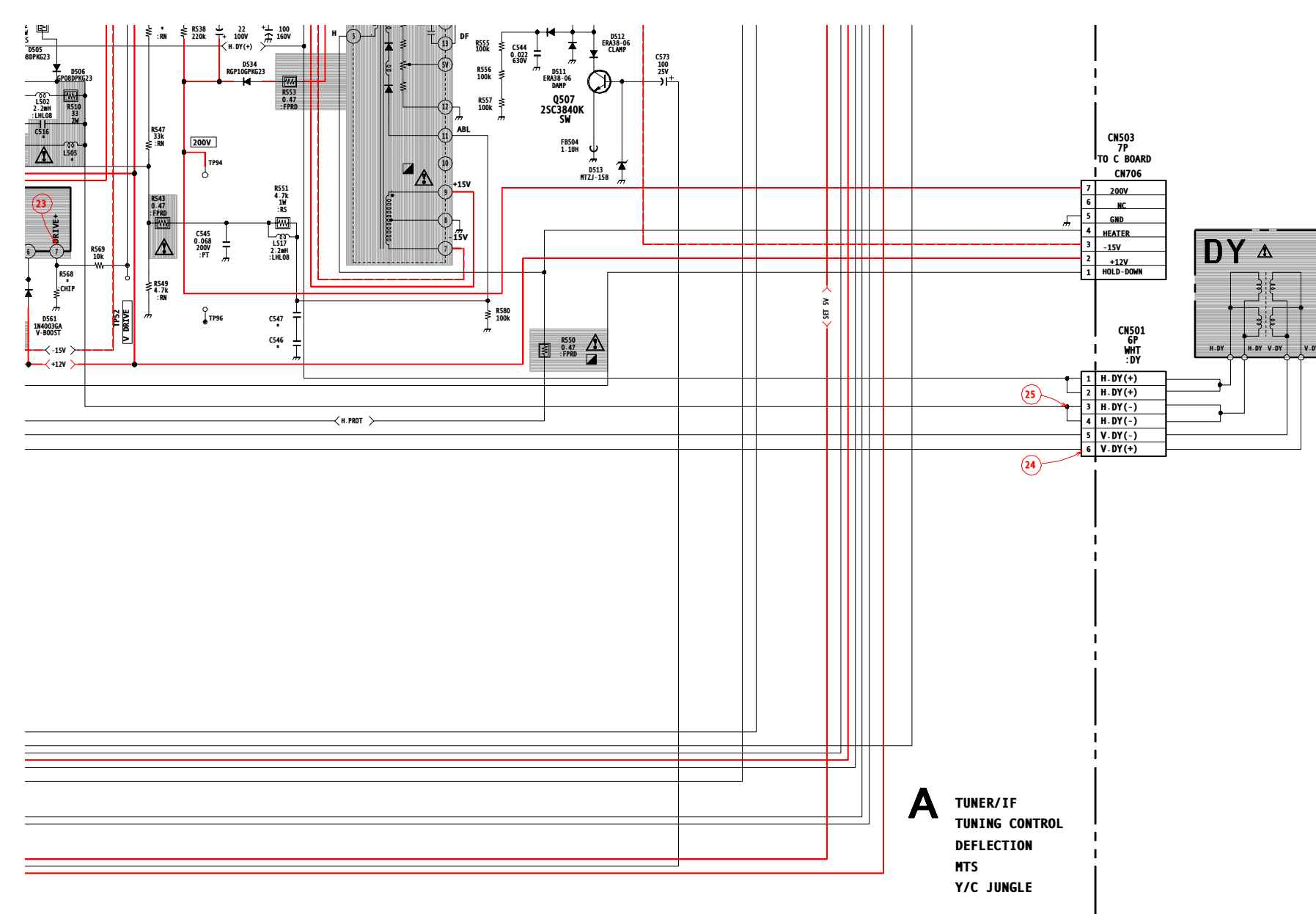

CN503  
7P  
TO C BOARD  
CN706

7	200V
6	NC
5	GND
4	HEATER
3	-15V
2	+12V
1	HOLD-DOWN

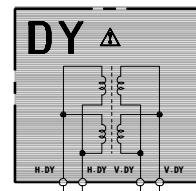

CN501  
6P  
MHT  
DY

1	H.DY(+)
2	H.DY(+)
3	H.DY(-)
4	H.DY(-)
5	V.DY(-)
6	V.DY(+)

**A** TUNER/IF  
TUNING CONTROL  
DEFLECTION  
MTS  
Y/C JUNGLE

**SONY**<sup>®</sup>

4-089-081-21



**FD Trinitron**  
**WEGA**<sup>®</sup>

---

Operating Instructions

KV-27FS100  
KV-27FS200  
KV-32FS100  
KV-32FS200  
KV-36FS100  
KV-36FS200





# WARNING

To reduce the risk of fire or electric shock, do not expose the TV to rain or moisture.

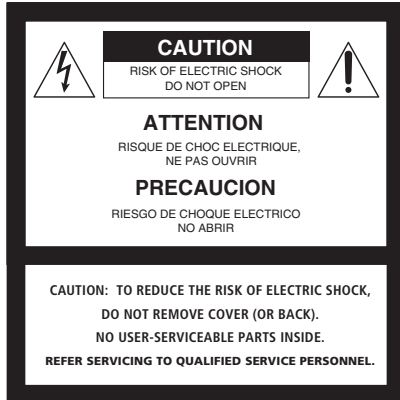

This symbol is intended to alert the user to the presence of uninsulated “dangerous voltage” within the product’s enclosure that may be of sufficient magnitude to constitute a risk of electric shock to persons.



This symbol is intended to alert the user to the presence of important operating and maintenance (servicing) instructions in the literature accompanying the appliance.

## Note to the CATV Installer

This reminder is provided to call the CATV system installer’s attention to Article 820-40 of the NEC that provides guidelines for proper grounding and, in particular, specifies that the cable ground shall be connected to the grounding system of the building as close to the point of cable entry as practical.

## SAFETY PRECAUTIONS

- Operate the TV only on 120 V AC.
- One blade of the power plug is wider than the other for safety purposes and will fit into the power outlet only one way. If you are unable to insert the plug fully into the outlet, contact your dealer.
- If any liquid or solid object falls into the TV, unplug it and have it checked by qualified personnel before operating it further.

## CAUTION

When using TV games, computers, and similar products with your TV, keep the brightness and contrast functions at low settings. If a fixed (non-moving) pattern is left on the screen for long periods of time at a high brightness or contrast setting, the image can be permanently imprinted onto the screen. Continuously watching the same channel can cause the imprint of station logos onto the TV screen. These types of imprints are not covered by your warranty because they are the results of misuse.



To reduce the risk of electric shock, do not use this polarized plug with an extension cord, receptacle, or other outlet unless the blades can be fully inserted to prevent blade exposure.



You are cautioned that any changes or modifications not expressly approved in this manual could void your authority to operate this equipment.

## NOTIFICATION

This equipment has been tested and found to comply with the limits for a Class B digital device pursuant to Part 15 of the FCC Rules. These limits are designed to provide reasonable protection against harmful interference in a residential installation. This equipment generates, uses, and can radiate radio frequency energy and, if not installed and used in accordance with the instructions, may cause harmful interference with radio communications. However, there is no guarantee that interference will not occur in a particular installation. If this equipment does cause harmful interference to radio or television reception, which can be determined by turning the equipment off and on, the user is encouraged to try to correct the interference by one or more of the following measures:

- Reorient or relocate the receiving antennas.
- Increase the separation between the equipment and receiver.
- Connect the equipment into an outlet on a circuit different from that to which the receiver is connected.
- Consult the dealer or an experienced radio/TV technician for help.

## Protecting the TV

- To prevent internal heat build-up, do not block the ventilation openings.
- Do not install the TV in a hot or humid place, or in a place subject to excessive dust or mechanical vibration.

## Note on Caption Vision

This television receiver provides display of television closed captioning in accordance with § 15.119 of the FCC rules. Use of this television for other than private viewing of programs broadcast on UHF or VHF or transmitted by cable companies for the use of the general public may require authorization from the broadcaster-cable company and/or program owner.

## Owner’s Record

The model and serial numbers are located on the front cover of this manual and at the rear of your TV.

## Trademarks and Copyrights

ENERGY STAR® is a registered mark.



As an ENERGY STAR® Partner, Sony has determined that this product or product model meets the ENERGY STAR® guidelines for energy efficiency.

WEGA, FD Trinitron and Caption Vision are registered trademarks of Sony Corporation.

# IMPORTANT SAFEGUARDS

For your protection, please read these instructions completely, and keep this manual for future reference. Carefully observe and comply with all warnings, cautions and instructions placed on the set, or described in the operating instructions or service manual.

## WARNING

To guard against injury, the following basic safety precautions should be observed in the installation, use, and servicing of the set.

## Use

### Power Sources

This set should be operated only from the type of power source indicated on the serial/model plate. If you are not sure of the type of electrical power supplied to your home, consult your dealer or local power company. For those sets designed to operate from battery power, refer to the operating instructions.



### Grounding or Polarization

This set is equipped with a polarized AC power cord plug (a plug having one blade wider than the other), or with a three-wire grounding type plug (a plug having a third pin for grounding). Refer to the following instructions:

#### For the set with a polarized AC power cord plug

This plug will fit into the power outlet only one way. This is a safety feature. If you are unable to insert the plug fully into the outlet, try reversing the plug. If the plug still fails to fit, contact your electrician to have a suitable outlet installed. Do not defeat the safety purpose of the polarized plug by forcing it in.



#### Alternate Warning

#### For the set with a three-wire grounding type AC plug

This plug will only fit into a grounding-type power outlet. This is a safety feature. If you are unable to insert the plug into the outlet, contact your electrician to have a suitable outlet installed. Do not defeat the safety purpose of the grounding plug.

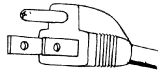

## Overloading

Do not overload wall outlets, extension cords or convenience receptacles beyond their capacity, since this can result in fire or electric shock. Always turn the set off when it is not to be used. When the set is left unattended and unused for long periods of time, unplug it from the wall outlet as a precaution against the possibility of an internal malfunction that could create a fire hazard.

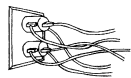

Do not disconnect the antenna or the power cord during a heavy storm. Lightning may strike while you are holding the cable or cord, causing serious injury. Turn off your TV and wait for the weather to improve.

## Object and Liquid Entry

Never push objects of any kind into the set through the cabinet slots as they may touch dangerous voltage points or short out parts that could result in a fire or electric shock. Never spill liquid of any kind on the set.



## Attachments

Do not use attachments not recommended by the manufacturer, as they may cause hazards. Do not place any objects, especially heavy objects, on top of the set. The object may fall from the set, causing injury.

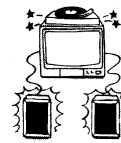

## Cleaning

Unplug the set from the wall outlet before cleaning or polishing it. Do not use liquid cleaners or aerosol cleaners. Use a cloth lightly dampened with water for cleaning the exterior of the set.



If a snapping or popping sound from a TV set is continuous or frequent while the TV is operating, unplug the TV and consult your dealer or service technician. It is normal for some TV sets to make occasional snapping or popping sounds, particularly when being turned on or off.



## Installation

Always use two or more people to lift or move the set. The set is heavy and the bottom surface is flat. Serious injury can result from trying to move the set by yourself alone, or from unsteady handling.

Install the set on a stable, level surface.

## Water and Moisture

Do not use power-line operated sets near water — for example, near a bathtub, washbowl, kitchen sink, or laundry tub, in a wet basement, or near a swimming pool, etc.



## Accessories

Do not place the set on an unstable cart, stand, tripod, bracket, table, or shelf. The set may fall, causing serious injury to a child or an adult, and serious damage to the set.



Use only a cart or stand recommended by the manufacturer for the specific model of TV. Any mounting of the product should follow the manufacturer's instructions, and should use a mounting accessory recommended by the manufacturer. An appliance and cart combination should be moved with care. Quick stops, excessive force, and uneven surfaces may cause the appliance and cart combination to overturn.

Disconnect all cables and cords from the set before attempting to move the set.

Do not allow children or pets to climb up onto, or push against, the set. The set may fall, causing serious injury.

## Ventilation

The slots and openings in the cabinet and in the back or bottom are provided for necessary ventilation. To ensure reliable operation of the set, and to protect it from overheating, these slots and openings must never be blocked or covered.

- Never cover the slots and openings with a cloth or other materials.



- Never block the slots and openings by placing the set on a bed, sofa, rug or other similar surface.

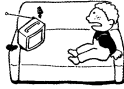

- Never place the set in a confined space, such as a bookcase or built-in cabinet, unless proper ventilation is provided.



- Do not place the set near or over a radiator or heat register, or where it is exposed to direct sunlight.



### Power-Cord Protection

Do not allow anything to rest on or roll over the power cord, and do not place the set where the power cord is subject to wear or abuse.



### Grounding or Polarization

This set may be equipped with a polarized alternating current line plug (a plug having one blade wider than other). This plug will fit into the power outlet only one way. This is a safety feature. If you are unable to insert the plug fully into the outlet, try reversing the plug. If the plug still fails to fit, contact your electrician to replace your obsolete outlet. Do not defeat the safety purpose of the polarized plug.

### Antennas

#### Outdoor Antenna Grounding

If an outdoor antenna is installed, follow the precautions below. An outdoor antenna system should not be located in the vicinity of overhead power lines or other electric light or power circuits, or where it can come in contact with such power lines or circuits.

WHEN INSTALLING AN OUTDOOR ANTENNA SYSTEM, EXTREME CARE SHOULD BE TAKEN TO KEEP FROM CONTACTING SUCH POWER LINES OR CIRCUITS AS CONTACT WITH THEM IS ALMOST INVARIABLY FATAL.

Be sure the antenna system is grounded so as to provide some protection against voltage surges and built-up static charges. Section 810 of the National Electrical Code (NEC) in USA and Section 54 of the Canadian Electrical Code in Canada provides information with respect to proper grounding of the mast and supporting structure, grounding of the lead-in wire to an antenna discharge unit, size of grounding conductors, location of antenna discharge unit, connection to grounding electrodes, and requirements for the grounding electrode.

#### Antenna Grounding According to the NEC

Antenna Grounding According to the National Electrical Code, ANSI/NFPA 70.

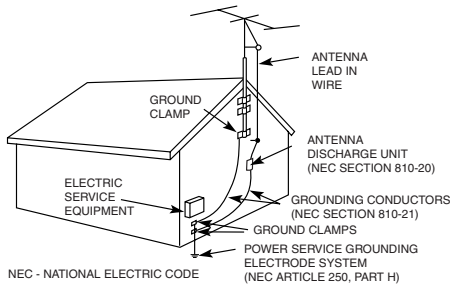





### Lightning

For added protection for this television receiver during a lightning storm, or when it is left unattended and unused for long periods of time, unplug it from the wall outlet and disconnect the antenna. This will prevent damage to the receiver due to lightning and power-line surges.

### Service

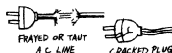
#### Damage Requiring Service

Unplug the set from the wall outlet and refer servicing to qualified service personnel under the following conditions:

- When the power cord or plug is damaged or frayed. 
- If liquid has been spilled into the set or objects have fallen into the product. 
- If the set has been exposed to rain or water. 
- If the set has been subject to excessive shock by being dropped, or the cabinet has been damaged. 
- If the set does not operate normally when following the operating instructions. Adjust only those controls that are specified in the operating instructions. Improper adjustment of other controls may result in damage and will often require extensive work by a qualified technician to restore the set to normal operation. 
- When the set exhibits a distinct change in performance — this indicates a need for service.

### Servicing

Do not attempt to service the set yourself since opening the cabinet may expose you to dangerous voltage or other hazards. Refer all servicing to qualified service personnel.



### Replacement Parts

When replacement parts are required, be sure the service technician certifies in writing that he has used replacement parts specified by the manufacturer that have the same characteristics as the original parts. Unauthorized substitutions may result in fire, electric shock, or other hazards.



### Safety Check

Upon completion of any service or repairs to the set, ask the service technician to perform routine safety checks (as specified by the manufacturer) to determine that the set is in safe operating condition, and to so certify. When the set reaches the end of its useful life, improper disposal could result in a picture tube implosion. Ask a qualified service technician to dispose of the set.





# Contents

## Introduction

Introducing the FD Trinitron WEGA® Features.....	1
About this Manual .....	2
Batteries for the Remote Control.....	2
Front Panel Menu Controls.....	2
Using the Remote Control .....	3

## Connecting Your TV

TV Rear Panel.....	5
Basic Connections .....	7
Cable Box Connections .....	8
Connecting Additional Equipment .....	10

## Using Basic Functions

Setting Up the TV Automatically.....	17
Quick Start to the Menus .....	18
Using Picture in Picture (PIP) .....	20
Setups that affect your ability to use PIP.....	22

## Using the Menus

How to access menus.....	23
Using the Video Menu.....	24
Using the Audio Menu.....	25
Using the Channel Setup Menu .....	27
Using the Parent Menu .....	29
Using the Timer Menu.....	35
Using the Setup Menu .....	36
Using the Basic Menu.....	37

## Other Information

Programming the Remote Control.....	39
Troubleshooting.....	42
Specifications.....	45

<b>Index</b> .....	47
--------------------	----





# Introduction

Congratulations on your purchase of the Sony FD Trinitron WEGA®. Before you begin using this manual, please check the model number located on the rear of your TV or on the front cover of this manual.

## Introducing the FD Trinitron WEGA® Features

Some of the features you will enjoy include:

- ❑ **FD Trinitron Flat CRT** — Technologically advanced tube delivers a picture with uncompromising accuracy and outstanding image detail.
- ❑ **Y, Pb, Pr Inputs** — A component video input connection for a superior picture quality (480i only).
- ❑ **Surround** — Simulates theater quality sound for stereo programs.
- ❑ **Parental Control (V-Chip)** — A tool to help parents monitor what their children watch on TV by establishing rating limits.
- ❑ **Picture in Picture (PIP)** — Allows you to view two programs simultaneously (KV-27FS200, KV-32FS200, KV-36FS200 only).
- ❑ **Favorite Channels** — Instant access to your favorite channels with the touch of a button.
- ❑ **Info Banner** — A new, convenient feature that displays the name and the remaining time of the current program viewed, if available.
- ❑ **Universal Remote Control** — Program your remote control to operate your connected cable box, VCR, digital satellite receiver, or DVD player.
- ❑ **Energy Star®** — Meets the Energy Star guidelines for energy efficiency.
- ❑ **Front Panel Controls** — Allows access to the on-screen menus without the use of a remote control.
- ❑ **Front A/V Inputs** — A quick connection for video games, camcorders or stereo/mono equipment.

## About this Manual

This manual provides instructions to help you enjoy your new TV. It shows you how to connect to an antenna or cable, cable box, VCR, DVD, satellite receiver, stereo system, or camcorder. Once you're connected, follow the instructions and use the remote control to access the on-screen menus.

## Batteries for the Remote Control

Insert two AA (R6) batteries (supplied) into the remote control using the following illustration as a guide.

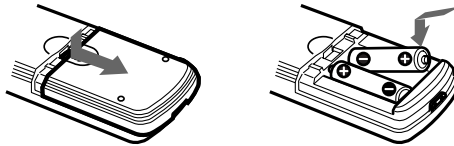



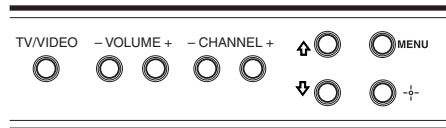

 Under normal conditions, batteries will last up to six months. If the remote control does not operate properly, the batteries might be worn out.

 If you will not be using the remote control for an extended period of time, remove the batteries to avoid possible damage from battery leakage.

## Front Panel Menu Controls



























The front Audio/Video panel controls allows you to access the menu without the remote control.

- Press  to display the on-screen menu.
- Use the  and  buttons on the front Audio/Video panel instead of your remote control.
- Use the  button on the front Audio/Video panel to navigate through the menus, then select an item. The front panel controls also allows you to change your channels CH +/-, adjust the volume VOL +/-, and change video inputs.







 To navigate the menus with your remote control, see "Using the Menus" on page 23.

## Using the Remote Control

 The remote control shown (RM-Y181) is for the models KV-27FS200, KV-32FS200 and KV-36FS200. The remote control for the models KV-27FS100, KV-32FS100, KV-36FS100 (RM-Y180); do not have the yellow labeled PIP function buttons.

Button	Description
 1	<b>MUTING</b> Press to turn off the sound. Press again or press  to restore sound.
 2	<b>SYSTEM OFF</b> Press to power off the equipment programmed into the remote control, see “Programming the Remote Control” on page 39.
 3	<b>TV/VCR</b> Press to switch between TV and VCR mode. If you have a non-Sony VCR, you will need to program the remote control to recognize your VCR. For details, see “Programming the Remote Control” on page 39.
 4	<b>ANT (antenna)</b> Press to change from VHF/UHF input to the AUX input, press again to switch back (KV-27FS200, KV-32FS200 and KV-36FS200 only).
 5	<b>PICTURE MODE</b> Press repeatedly to step through the available video picture modes: Vivid, Standard, Movie and Sports. Also available in the Video menu. See “Using the Video Menu” on page 24 for details.
 6	<b>SLEEP</b> Press repeatedly until the TV displays the time in minutes (15, 30, 45, 60, or 90) that you want the TV to remain on before shutting off automatically. Cancel by pressing until Sleep Off appears. While Sleep feature is set, press once to view remaining time.
 7	<b>JUMP</b> Press to jump back and forth between two channels. The TV alternates between the current channel and the last channel that was selected.
 8	<b>TV/SAT</b> Press to switch between the TV and SAT (satellite) inputs when in SAT FUNCTION mode.
 9	<b>RESET</b> Press to return to factory settings while in an on-screen menu.
 10	<b>VOL (volume)</b> Press (+) or (-) to adjust the volume.
 11	<b>CODE SET</b> Use to program your remote control to operate connected video equipment. See “Programming the Remote Control” on page 39.
 12	
 13	
 14	
 15	
 16	
 17	
 18	
 19	
 20	
 21	
 22	

## Operating Instructions

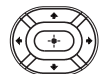
Button	Description
<b>12 POWER buttons</b>	Press to turn on and off the TV and other audio/video equipment you have programmed into the remote control. For instructions, see "Programming the Remote Control" on page 39.
<b>13 FUNCTION buttons</b>	Press to select the equipment (TV, VCR/DVD, SAT/CABLE) that you want to operate with the remote control. The indicator (LED) lights up momentarily when pushed to show which device the remote control is operating.
<b>14 PIP (Picture in Picture)</b>	Operates PIP feature. See "Using Picture in Picture (PIP)" on page 20.
<b>VCR (operating)</b>	Operates your VCR. The VCR must be programmed into the remote control. For instructions, see "Programming the Remote Control" on page 39.
<b>REC</b>	Press  button and the  button - above left - at the same time to record any programs with your VCR (the remote control must be programmed in order to use REC).
	Rewind.
	Fast-forward.
	Play.
	Stop.
<b>II</b>	Pause. Press again to resume normal playback.
<b>15 TV/VIDEO</b>	Press to cycle through available video inputs.
<b>16 DISPLAY</b>	Press once to display the current time and program status (such as channel number, channel label (if set), video input, and video label). Press again to turn display off.
<b>17 MTS/SAP</b>	Press to cycle through the Multi-channel TV Sound (MTS) options: Stereo, Auto SAP (Second Audio Programming), and Mono.
<b>18 0-9 and ENTER</b>	Press to change channels directly. The channel changes after 2 seconds.
<b>19 GUIDE</b>	Press to display the program guide of your satellite antenna.
<b>20</b> 	Press the arrow buttons to move the cursor in the on-screen menus. Press the center button to select or access an option.
<b>21 MENU</b>	Press to display the on-screen menu. Press again to exit the menu at any time.
<b>22 CH (channel)</b>	Press to change channels. To scan rapidly through the channels, press and hold down the CH+ or CH- button.

 For information on Picture in Picture (PIP) operation buttons, see page 21.

 If you lose your remote control, see page 44.

# Connecting Your TV

Read this section before setting up your TV for the first time. This section covers basic connections in addition to any optional equipment you may be connecting.

 The TV rear panels illustrated in this manual are for KV-27FS200, KV-32FS200 and KV-36FS200. The KV-27FS100, KV-32FS100 and KV-36FS100; do not have the AUX input and TO CONVERTER output jack.

## TV Rear Panel

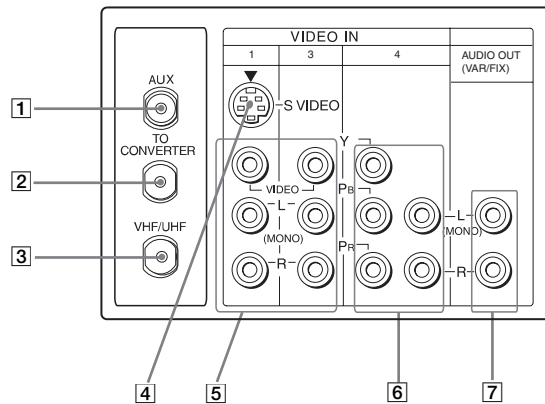

Jack	Description
<b>1</b> AUX	This input allows you to view local and cable channels if your cable provider does not feature local channels. You can switch between local and cable channels easily by pressing ANT on the remote control. Devices connected to the AUX input cannot be viewed in PIP.
<b>2</b> TO CONVERTER	This is a VHF/UHF out jack that lets you set up your TV to switch between scrambled channels (through a cable box) and normal cable channels (CATV). Use this jack instead of a splitter to get better picture quality when you need to switch between scrambled and unscrambled cable channels.
<b>3</b> VHF/UHF	This input connects to your VHF/UHF antenna or cable.
<b>4</b> S VIDEO	This input connects to the S VIDEO OUT jack on your VCR or other video equipment that has S VIDEO. S VIDEO provides better picture quality than the VHF/UHF jacks or the video input jack. S VIDEO does not provide sound; you still must connect the audio cables.

## Connecting Your TV

---

Jack	Description
<b>5 AUDIO L(MONO), R/ VIDEO</b>	This input connects to the AUDIO/VIDEO output jacks on your VCR or other video equipment. A third video input jack (VIDEO 2) is located on the front panel of the TV. These AUDIO/VIDEO input jacks provide better picture quality than the VHF/UHF jack.
<b>6 Y, P<sub>B</sub>, P<sub>R</sub>/ L(MONO), R</b>	This input connects to the component video Y, P <sub>B</sub> , P <sub>R</sub> , and AUDIO L(MONO), R jacks on your DVD player or digital set-top box (480i only).
<b>7 AUDIO OUT (VAR/FIX) L(MONO), R</b>	Connects to the AUDIO L(MONO), R input jacks on your audio equipment. You can listen to your TV's audio through your stereo system.



## Basic Connections

### TV with Indoor or Outdoor Antenna, or CATV Cable

Depending on the cable available in your home, choose one of the connections below:

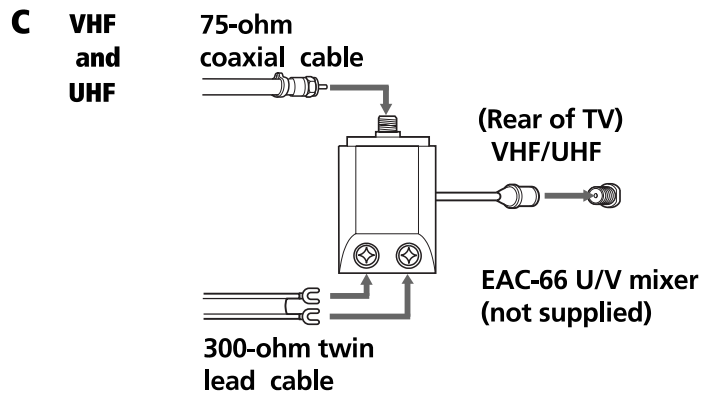
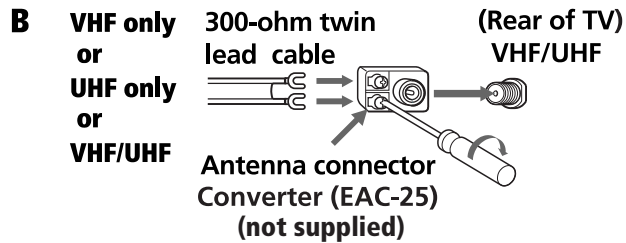
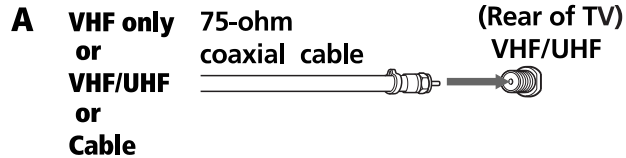

 If you are connecting to an indoor or outdoor antenna, you may need to adjust the orientation of the antenna for best reception.

### Cable Box Connections

Some cable TV systems use scrambled or encoded signals that require a cable box to view all channels. If you subscribe to that kind of cable service, use this connection. Scrambled signals coming in to the TV through the cable box cannot be viewed in PIP. If some of your channels are scrambled, consider using the Cable Box and Cable connection.

#### Cable Box and TV

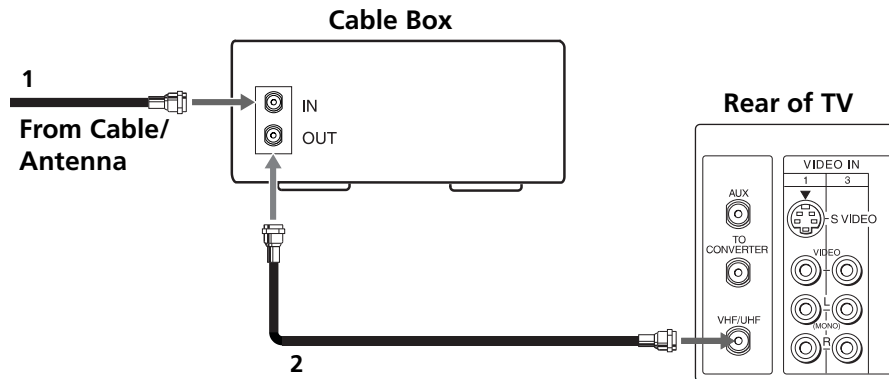

- 1** Connect the coaxial cable from your cable service to the IN jack on your cable box.
- 2** Connect a coaxial cable (not supplied) from the OUT jack on your cable box to the VHF/UHF jack on your TV.

 If you will be controlling all channel selection through your cable box, you should consider using the Channel Fix feature to set your TV to channel 3 or 4 (see page 27).

### Cable Box and Cable

Use this connection if you subscribe to a cable system that scrambles some channels (pay channels) but not all of them. This setup allows you to use the remote control to:

- ❑ change channels through your cable box when you are receiving a scrambled signal
- ❑ change channels through your TV

This connection also allows you to use the PIP feature when you are viewing unscrambled channels coming directly into your TV from your cable. Scrambled signals coming through the cable box cannot be viewed in PIP. For more information on the PIP feature, see page 20.

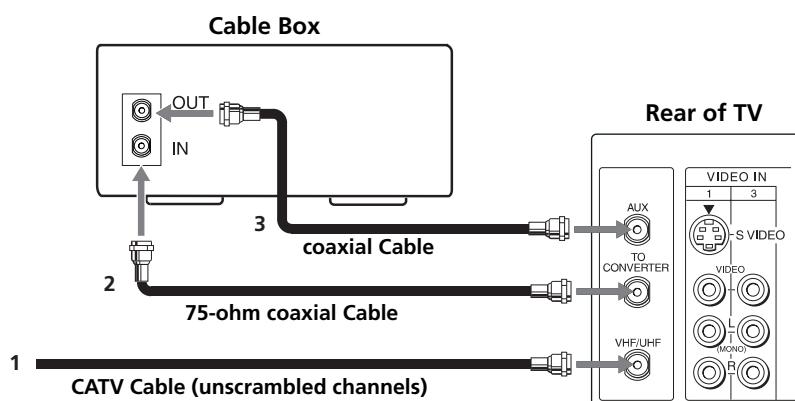

- 1** Connect the coaxial cable from your cable service to the VHF/UHF jack on your TV.
- 2** Using a coaxial cable (not supplied), connect the IN jack on your cable box to the TO CONVERTER jack on your TV.
- 3** Using a coaxial cable (not supplied), connect the OUT jack on your cable box to the AUX jack on your TV.

Press the ANT button on the remote control to switch between the cable box and direct cable inputs.

Your Sony remote control can be programmed to operate your cable box (see page 40).

To use the cable box to change your channels, set your TV to channel 3 or 4. Use the Channel Fix feature to ensure that you don't accidentally switch channels using your TV (see page 27).

## Connecting Additional Equipment

### Connecting a TV and VCR

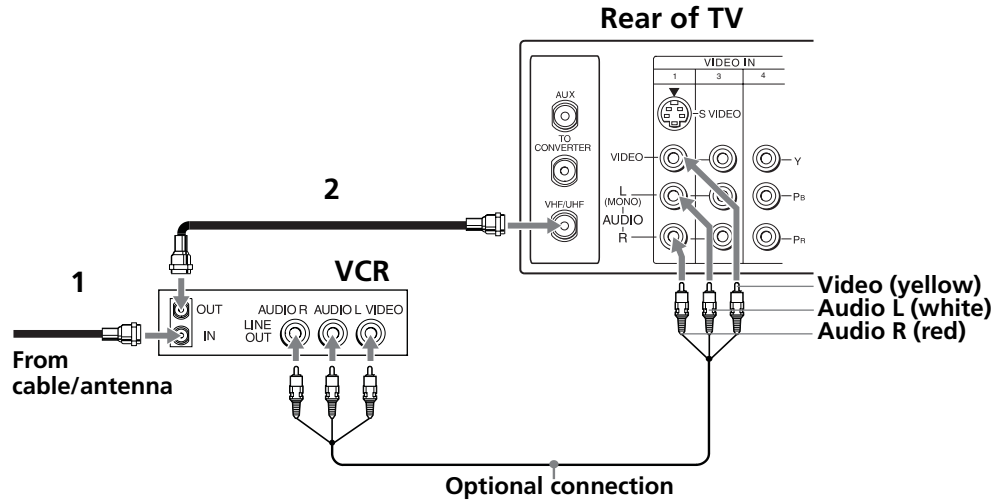

To watch video programs from your VCR, tune your TV to channel 3 or 4 (as set on the rear of your VCR).

- 1** Connect the coaxial cable from your TV antenna or cable service to the IN jack on your VCR.
- 2** Connect a coaxial cable (not supplied) from the OUT jack on your VCR to the VHF/UHF jack on the TV.

#### Optional connection

If your VCR is equipped with video outputs, you can get better picture quality by connecting audio/video cables (not supplied) from AUDIO/VIDEO OUT on your VCR to AUDIO/VIDEO IN on your TV.

You can use the button to switch between the VHF/UHF and VIDEO inputs.

For better picture quality, use S VIDEO instead of the yellow video cable. S VIDEO does not provide sound; you still must connect the audio cables.

## Connecting a TV, VCR, and Cable Box

Use this connection if you subscribe to a cable system that scrambles some channels (pay channels), but not all of them. This setup allows you to use the remote control to:

- change channels through your cable box or VCR when you are receiving a scrambled signal
- change channels through your TV

This connection also allows you to use the PIP feature when you are viewing unscrambled channels coming directly into your TV from your cable. Scrambled signals coming through the cable box cannot be viewed in PIP. For more information on the PIP feature, see page 20.

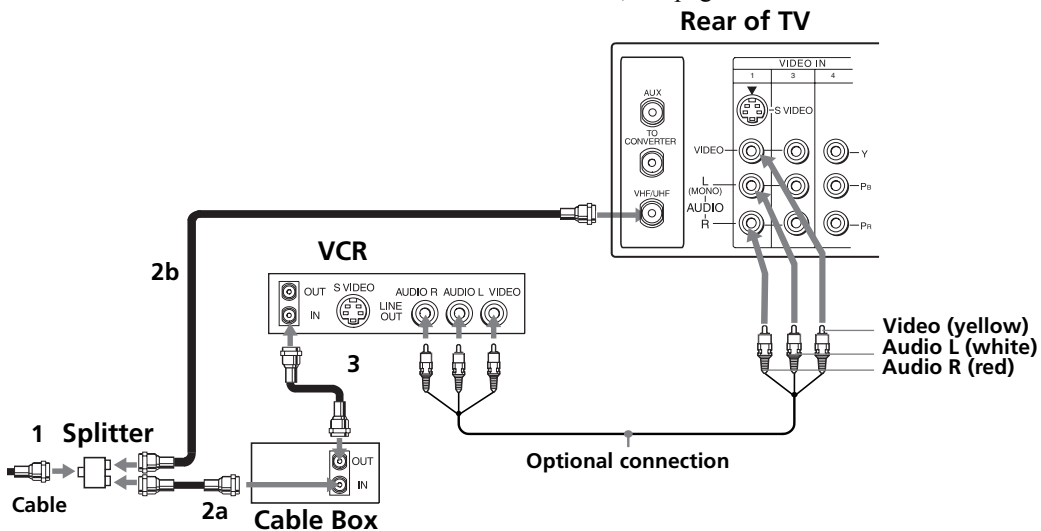

- 1** Connect the single input jack of the splitter to your incoming cable connection.
- 2** Using a coaxial cable (not supplied), connect the two output jacks of the splitter to:
  - a)** the IN jack on your cable box, and
  - b)** the VHF/UHF jack on the TV.
- 3** Using a coaxial cable (not supplied), connect the OUT jack on your cable box to the IN jack on your VCR.

If you will be controlling all channel selections through your cable box, you should consider using the Channel Fix feature to set your TV to channel 3 or 4 (see page 27).

You can use the button to switch between the VHF/UHF and VIDEO inputs.

## Connecting Your TV

### Optional connection

If your VCR is equipped with video outputs, you can get better picture quality by connecting audio/video cables (not supplied) from AUDIO/VIDEO OUT on your VCR to AUDIO/VIDEO IN on your TV.

 For better picture quality, use S VIDEO instead of the yellow video cable. S VIDEO does not provide sound; you still must connect the audio cables.

### Connecting a TV and Satellite Receiver

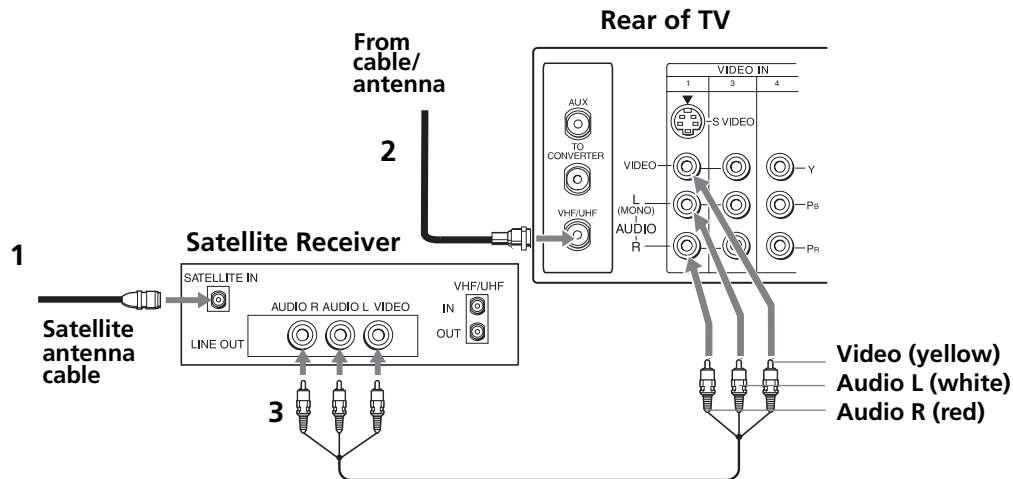

- 1** Connect the cable from your satellite antenna to SATELLITE IN on your satellite receiver.
- 2** Connect the coaxial cable from your cable service or antenna to the VHF/UHF jack on your TV.
- 3** Using audio/video cables (not supplied), connect AUDIO and VIDEO OUT on your satellite receiver to AUDIO/VIDEO IN on your TV.

 You can use the **TVVIDEO** button to switch between the VHF/UHF and VIDEO inputs.

 For better picture quality, use S VIDEO instead of the yellow video cable. S VIDEO does not provide sound; you still must connect the audio cables.

## Connecting a TV, Satellite Receiver, and VCR

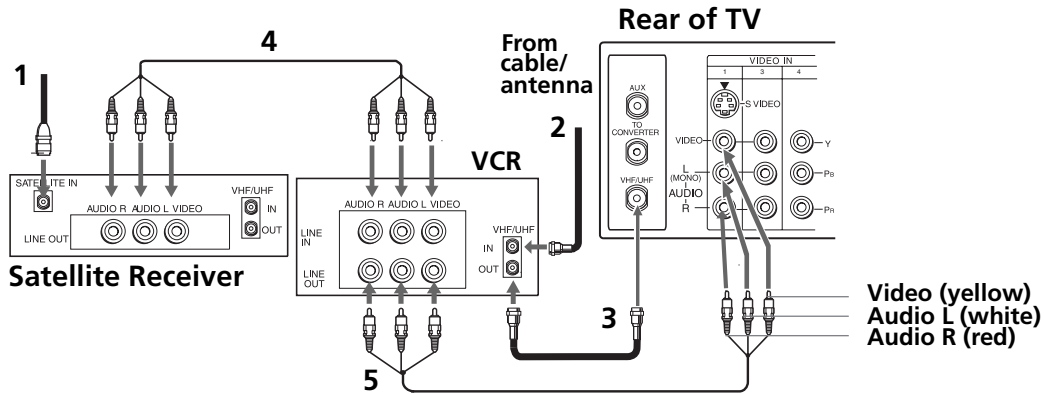

- 1** Connect the coaxial cable from your satellite antenna to SATELLITE IN on the satellite receiver.
- 2** Connect the coaxial cable from your cable service or antenna to the IN jack on your VCR.
- 3** Using a coaxial cable (not supplied), connect the OUT jack on your VCR to the VHF/UHF jack on your TV.
- 4** Using audio/video cables (not supplied), connect AUDIO/VIDEO OUT on your satellite receiver to AUDIO/VIDEO IN on your VCR.
- 5** Using audio/video cables (not supplied), connect AUDIO/VIDEO OUT on your VCR to AUDIO/VIDEO IN on your TV.

 To view from the satellite receiver or VCR, select the video input to which your satellite receiver or VCR is connected by pressing  $\text{TV/VIDEO}$  on the remote control.



## Connecting Your TV

### Connecting a DVD Player

Using audio/video cables (not supplied), connect AUDIO/VIDEO OUT on your DVD player to AUDIO/VIDEO IN on your TV.

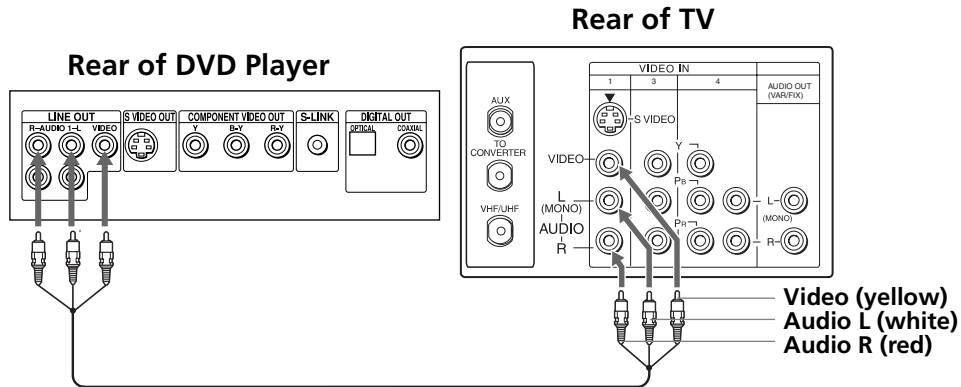

For better picture quality, use S VIDEO instead of the yellow video cable. S VIDEO does not provide sound; you still must connect the audio cables.

### Optional connection

If your DVD player is equipped with component video outputs (Y, P<sub>B</sub>, P<sub>R</sub>), you can improve the picture quality by using component video cables (480i only).

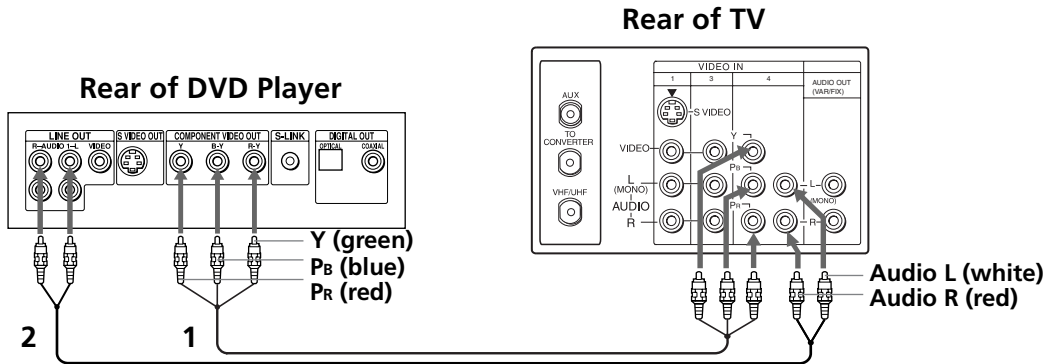

- 1 Using component video cables (not supplied), connect the Y, P<sub>B</sub>, P<sub>R</sub> OUT on your DVD player to Y, P<sub>B</sub>, P<sub>R</sub> IN on your TV.
- 2 Connect AUDIO OUT on your DVD player to AUDIO IN on your TV.

The Y, P<sub>B</sub>, P<sub>R</sub> outputs on your DVD player are sometimes labeled Y, C<sub>B</sub>, and C<sub>R</sub> or Y, B-Y, and R-Y. If so, connect the cables to like colors.

## Connecting a Camcorder

Using audio/video cables (not supplied), connect AUDIO/VIDEO OUT on your camcorder to AUDIO/VIDEO IN on your TV.

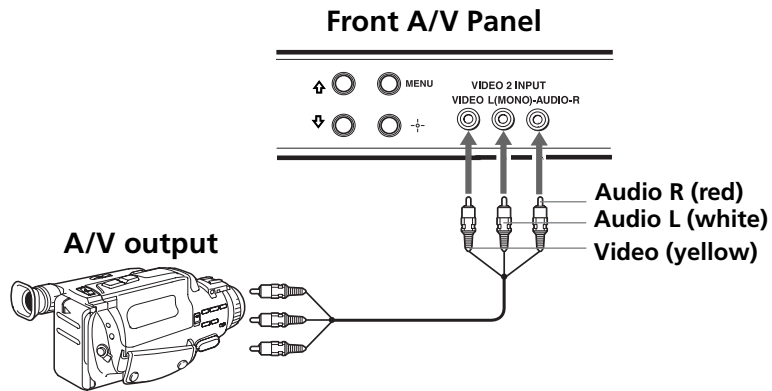

## Connecting an Audio System

Using audio cables (not supplied), connect AUDIO OUT on your TV to one of the unused line inputs (e.g. TV, AUX, TAPE2) on your stereo.

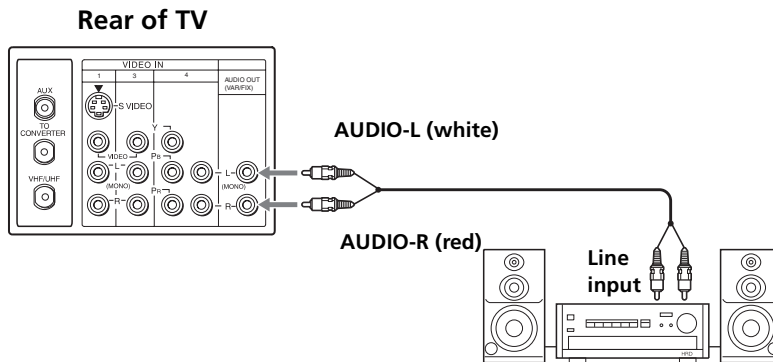

 Set your stereo to the selected line input. See "Using the Audio Menu" on page 25 for additional audio setup instructions.





# Using Basic Functions

## Setting Up the TV Automatically

After you have finished connecting your TV, you can perform Auto Program to set up your channels. When Auto Programming, the TV will automatically search for available channels and program receivable channels.

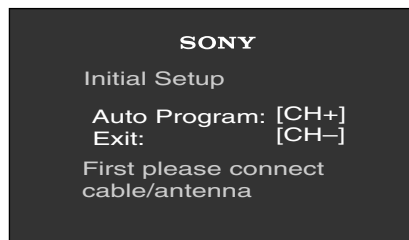









- 1 Press  to turn on the TV. The Initial Setup screen appears.





- 2 Press  on the remote control or on the TV front panel to perform Auto Program, or press  to exit.

 The Initial Setup screen appears each time you turn on the TV until you perform Auto Program.

### To perform Auto Program again

- 1 Press .
- 2 Press  to highlight Channel Setup Menu.
- 3 Press  to highlight Cable. Press  to select.
- 4 Press  or  to select On or Off according to how you connected your TV. Press .
- 5 Press  to highlight Auto Program. Press  to search for channels.
- 6 After performing Auto Program, press  to exit.

### To reset the TV to factory settings

- 1 Turn the TV on.
- 2 Hold down  on the remote control.
- 3 Press and release the POWER button on the TV front panel. (The TV will turn itself off, then back on.)
- 4 Release .

## Quick Start to the Menus

The following settings are available in your on-screen menus. For more details on how to use the menus, see “Using the Menus” on page 23.

---

**Menu**

**Allows you to**

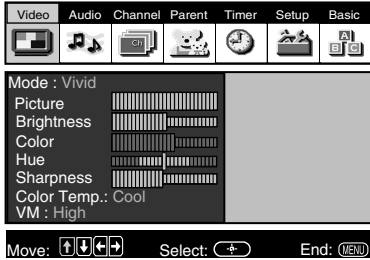

Make adjustments to your picture settings.

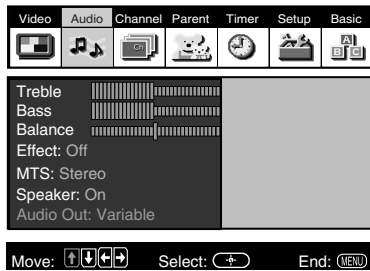

Change your audio settings.



Customize your channel settings.

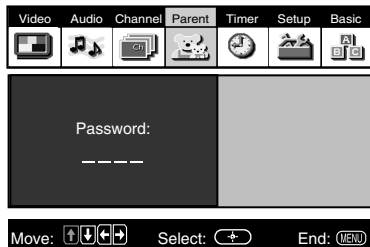

Set rating limits on your TV based on program rating or content.

Menu

Allows you to

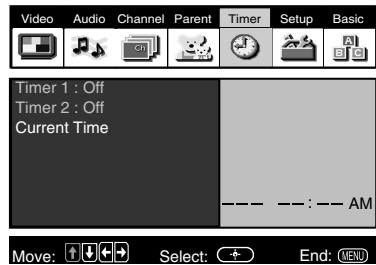

Set the clock on your TV and program scheduled viewing using Timer 1 and Timer 2.

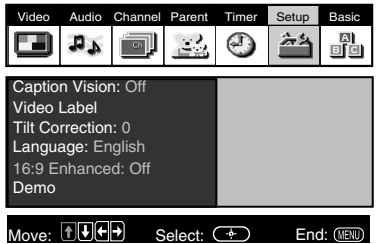

Select closed captioning options, label video inputs, adjust tilt correction, enhance your picture resolution for your DVD (16:9 Enhanced), select menu language, or run a demo of the menus.

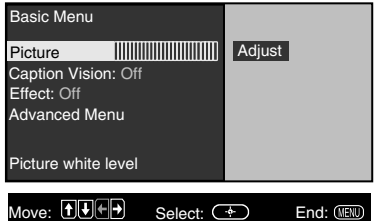
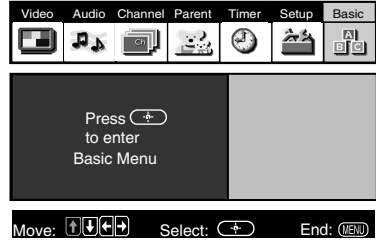

Set the menus to display a simplified menu of most commonly-used menu settings.

# Using Picture in Picture (PIP)

The Picture-in-Picture (PIP) feature allows you to view two programs simultaneously, one in the full size “main” picture and one in a small “window” picture.

 The PIP feature is only for the models KV-27FS200, KV-32FS200 and KV-36FS200.

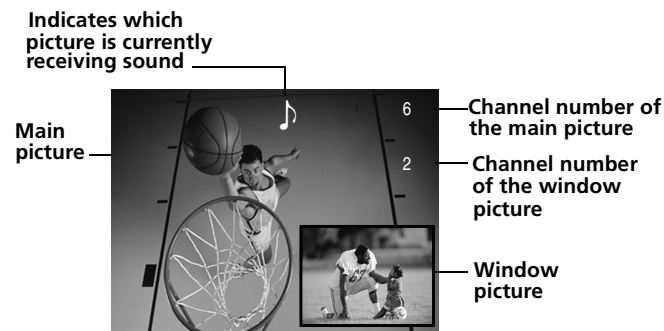

## Displaying Picture in Picture



### To use PIP

- 1 Press the TV button in the FUNCTION bar to control PIP with the yellow-labeled buttons. Tune your TV to a channel, which you know is currently airing programming.
- 2 Press the  button to display the window picture.
- 3 Use the PIP (yellow) CH +/- buttons to change the channel in the PIP window picture.









### To check your PIP

- 1 Press the TV button in the FUNCTION bar to control PIP with the yellow-labeled buttons. Tune your TV to a channel, which you know is currently airing programming.
- 2 Press the  to turn PIP on. Press , the channel from the main window should now appear in the window picture.
- 3 Select the same channel in the main picture (use the CH +/- buttons on the bottom of your remote control). You should now have the same program playing in both windows.
- 4 Use the PIP (yellow) CH +/- buttons to change the channel in the PIP window picture.
- 5 Press the  PIP (yellow) button to switch the PIP window to other video inputs for other equipment that is connected to any of the VIDEO IN jacks of your TV. You should see a different picture in your PIP window for each piece of connected video equipment. Make sure the connected equipment is turned on and working when you perform this test.
- 6 If the PIP feature does not work properly with the TV or the connected video equipment, refer to the troubleshooting section beginning on page 42.

 If you're having problems with PIP, refer to "Setups that affect your ability to use PIP" (page 22) or see Troubleshooting section (page 42) for possible solutions.



**PIP Functions buttons**

<b>Yellow labeled PIP button</b>	<b>Description</b>
	Press to turn the PIP feature on and off. Press repeatedly to change the window size (1/9, 1/16, Off).
	Press to cycle through the available video equipment you have connected to the TV (in the PIP window picture).
	Press to alternate sound between the main picture and the PIP window picture. The sound symbol  appears for three seconds, indicating whether you are hearing the sound from the main or PIP window picture.
	Press to change the channel in the PIP window picture. To change the channel in the main window, use the main CH +/- buttons at the bottom of the remote control.
	Press to move the location of the window picture to any of the four corners of the screen.
	Press to freeze the window picture. Press again to restore the picture. The main window continues to play as usual.
	Press to switch the main picture with the PIP window picture. Press again to switch back.

 For more information about your remote control, see "Using the Remote Control" on page 3.

**To change channels/programs in the PIP window**

- Use the yellow PIP CH +/- button to scroll through TV channels.
- Use the yellow TV/VIDEO button to cycle through your other video equipment connected to the TV, such as your VCR, DVD player, or satellite receiver.

## **Setups that affect your ability to use PIP**

 The PIP feature is only for the models KV-27FS200, KV-32FS200 and KV-36FS200.

- ❑ Any video equipment you have connected to the AUX input cannot be viewed in the PIP window.
- ❑ If you are viewing all channels through a cable box, the PIP feature will not work. The cable box only unscrambles one signal at a time, so the window picture will be the same as the main picture.
- ❑ You can use PIP to see pictures from different sources on your TV. For example, you can have a regular (CATV) channel and the output from a VCR, DVD player or satellite receiver on screen at the same time using PIP. To do this:
  - 1** Connect the CATV cable to the VHF/UHF input on the back of the TV.
  - 2** Connect the peripheral (VCR, DVD player or satellite receiver) to any of the VIDEO IN inputs on the back of the TV.
  - 3** Tune to one image in the main picture.
  - 4** Tune to a second image in the PIP window.







You can then SWAP the images on the TV screen.



 You cannot use a signal from the AUX input with PIP.

# Using the Menus

This section shows the options available for setting up and adjusting the TV.

## How to access menus

- 1** Press  to display the on-screen menu.
- 2** Use the  or  buttons to highlight the desired menu icon. Press  to select it.
- 3** Use the  or  buttons to scroll up and down through the features.
- 4** Follow the instructions on the screen.
- 5** See the specific menu page for instructions on moving through the menu.
- 6** Press  to exit the menu.

 Press  once to display the on-screen menu, and press again to return to normal viewing. If no buttons are pressed, the menu closes automatically after about 90 seconds.

## Using the Video Menu



To access the Video menu, refer to the following steps:

### To Display



### To Select



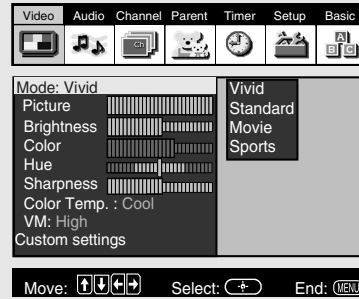

Press  to highlight an option then press .





### Mode











*Customized picture viewing*

Use the  or  buttons to select from one of the following options, then press  to select it.

- Vivid:** Select for enhanced picture contrast and sharpness.
- Standard:** Select for a standard picture.
- Movie:** Select for a finely detailed picture.
- Sports:** Select for a bright picture.



 Press  button on the remote control for direct access to the Picture Modes (Vivid, Standard, Movie, Sports).

### Picture Controls

- Picture:** Press  to decrease the contrast. Press  to increase contrast.
- Brightness:** Press  to darken the picture. Press  to brighten the picture.
- Color:** Press  to decrease color saturation. Press  to increase color saturation.
- Hue:** Press  to increase the red tones. Press  to increase the green tones.
- Sharpness:** Press  to soften the picture. Press  to sharpen the picture.

### Color Temp.



*White tint adjustment*

Use the  or  buttons to select from one of the following options, then press  to select it.

- Cool:** Gives white colors a blue tint.
- Neutral:** Gives white colors a neutral tint.
- Warm:** Gives white colors a red tint.

### VM



*Velocity Modulation*

Sharpens picture definition to give objects a sharp, clean edge. Use the  or  buttons to select from one of the following options: **High, Low, Off**, then press .







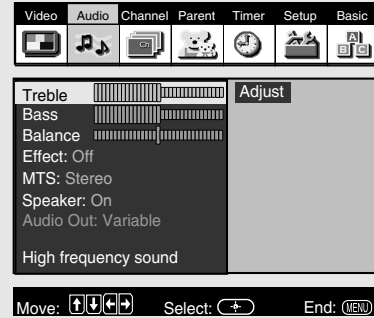

## Using the Audio Menu



To access the Audio menu, refer to the following steps:







Press  to highlight an option then press .





<b>Treble</b>	Press  to decrease the higher pitched sound. Press  to increase the higher pitched sound.
<b>Bass</b>	Press  to decrease the lower pitched sound. Press  to increase the lower pitched sound.
<b>Balance</b>	Press  to emphasize the left speaker. Press  to emphasize the right speaker.
<b>Effect</b>	Use the  or  buttons to select from one of the following options, then press  to select it. <b>Surround:</b> Simulates theater quality sound for stereo programs. <b>Off:</b> Normal stereo or mono reception.

 Press  for direct selection of Effect settings (Surround, Off).

<b>MTS</b> <i>Multi-Channel TV Sound</i>	Use the  or  buttons to select from one of the following options, then press  to select it. <b>Stereo:</b> Select when viewing a broadcast in stereo. <b>Auto SAP:</b> Select to have the TV automatically switch to a Second Audio Program (SAP) when a signal is received. <b>Mono:</b> Select to reduce noise in areas of poor reception.
---	--

 Press  button on the remote control for direct access to the MTS settings (Stereo, Auto SAP, Mono).

<b>Speaker</b> <i>Custom selection of audio output source</i>	Use the  or  buttons to select from one of the following options, then press  to select it. <b>On:</b> Select to listen to the sound from the TV speakers with or without a separate stereo system. <b>Off:</b> Select to turn off the TV speakers and listen to the TV's sound only through external audio system speakers.
--	---

## Operating Instructions

---

**Audio Out** Use the  $\uparrow$  or  $\downarrow$  buttons to select from one of the following options, then press  $\rightarrow$  to select it.  
*Use to control the TV's volume through a stereo* **Variable:** Adjust the volume through your TV.  
**Fixed:** Adjust the volume through a connected stereo.

 Audio Out settings can only be set when Speaker is set to Off.

 If your TV is set to Auto SAP, some programs may be muted or distorted. If your TV does not output sound, change your Audio MTS setting to Stereo or Mono.

## Using the Channel Setup Menu

To access the Channel Setup menu, refer to the following steps:

**To Display**







**To Highlight**



**To Select**















Video	Audio	Channel	Parent	Timer	Setup	Basic
Favorite Channels		Program				
Cable : On						
Channel Fix: Off						
Auto Program						
Channel Skip/Add						
Channel Label						
Program favorite channels						
Move: 		Select: 		End: 		

Press  to highlight an option then press .



### **Favorite Channels**

*Quick access to favorite channels*

- 1 Use the  or  buttons to select the position (1-8) where you want to set a favorite channel, then press .
- 2 Use the  or  buttons to find the channel you want to add to your favorite channels.
- 3 Press  to select the channel. The TV will automatically change to the selected channel.
- 4 Press  to return to the Channel Setup menu or press  to exit.

 To use Favorite Channels: Exit all menus and press . Press  or  to move the cursor to the desired channel number and press .



### **Cable**

Use the  or  buttons to select from one of the following options, then press  to select it.

- On:** Select if you are receiving cable channels with a CATV cable.  
**Off:** Select if you are using a TV antenna.

 After changing your cable settings, you will need to perform Auto Program.

### **Channel Fix**

Use the  or  buttons to select from one of the following options, then press  to select it.

- Off:** Channel Fix is not set.
- 2-6:** Select when you want to control all channel selection through a cable box or VCR. Select the appropriate channel (usually 3 or 4) and use the cable box's or VCR's remote control for channel selection.
- AUX 2-6:** Use this setting instead of the **2-6** if you want to change channels using a cable box, VCR or satellite receiver and you've connected it to the AUX input (KV-27FS200, KV-32FS200, KV-36FS200 only).
- Video 1:** Select from available video inputs when you have connected video equipment (e.g. satellite receiver) and you want your TV fixed to it.



## Operating Instructions

---

**Auto Program** Perform Auto Program whenever setting up your TV.  
Auto Program will search for available channels and program receivable channels.

**Channel Skip/Add** Use this feature after you run Auto Program to skip unwanted channels or add new ones.

- 1 Use the  $\uparrow$  or  $\downarrow$  buttons to select the position of the desired channel, then press  $\ominus$ .
- 2 Use the  $\uparrow$  or  $\downarrow$  buttons to select Skip or Add, then press  $\ominus$ .
- 3 Press  $\leftarrow$  to return to the Channel Setup menu or press  $\text{MENU}$   $\ominus$  to exit.

 Pressing CH + or CH - will skip over channels that have been skipped. You can still use the  $\text{0-9}$  buttons to directly tune to skipped channels.

**Channel Label** 1 Press  $\ominus$ , then use the  $\uparrow$  or  $\downarrow$  buttons until you reach the desired channel number.

*Label up to 40 channels with their call letters*

- 2 Press  $\ominus$  to activate the channel.
- 3 Press  $\downarrow$  to highlight "Label", then press  $\ominus$ . Use the  $\uparrow$  or  $\downarrow$  buttons to display the first call letter or number of the caption. Press  $\ominus$  to select. Repeat this process until you finish selecting all the call letters.
- 4 When finished, press  $\ominus$  to activate.
- 5 Press  $\leftarrow$  to return to the Channel Setup menu or press  $\text{MENU}$   $\ominus$  to exit.

 You cannot use Favorite Channels, Cable, Channel Skip/Add, and Channel Label when Channel Fix is set.

## Using the Parent Menu

To access the Parent menu, refer to the following steps:

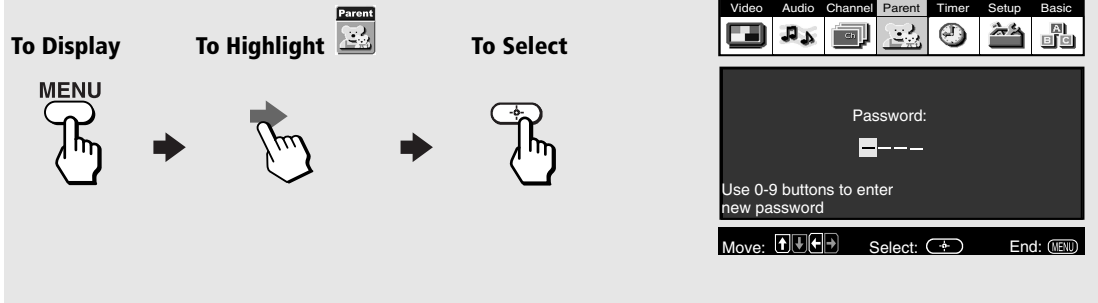

The diagram illustrates the three steps to access the Parent menu:

- To Display:** Press the **MENU** button.
- To Highlight:** Press the **Right Arrow** button.
- To Select:** Press the **Enter/Select** button.

On the right, a screenshot of the Parent menu interface is shown. The menu bar includes Video, Audio, Channel, Parent, Timer, Setup, and Basic. The Parent menu is selected, displaying a password prompt: "Password: [ ]". Below the prompt, it says "Use 0-9 buttons to enter new password". At the bottom of the screen, navigation controls are visible: Move (Up, Down, Left, Right), Select (Enter), and End (MENU).

The Parental Control feature is designed to help parents monitor what their children watch on television.

### To use the Parent Menu

In Parent menu, you will be asked to set a 4-digit password for any further access into Parent menu.

- 1** Use the **0-9** buttons to enter a 4-digit password.
- 2** Confirm your password by entering it again.

 Keep this manual in a safe place. You need your password for any future access to the Parental Control menu. If you forget your password, see page 44.

Once your password is set correctly, the Parent menu appears.

## Parental Control

### Setting the Rating

You can change the Rating by selecting one of the Parental Lock options.



- 1 Press  $\downarrow$  to highlight Parental Lock, press  $\rightarrow$ .

If you are not familiar with Parental Guideline rating system, use one of the following preset categories to simplify the rating selection: Child, Youth, Young Adult.

- 2 Use the  $\uparrow$  or  $\downarrow$  to select the desired rating and press  $\rightarrow$ .

Rating	TV will allow a maximum rating of
Child	TV-Y, TV-G, G (U.S.), G, C (Canada)
Youth	TV-PG, PG (U.S.), 8 ans + (Canada)
Young Adult	TV-14, PG-13 (U.S.), 14+ (Canada)
Custom	Select to set more restrictive ratings (see next section)
Off	No rating limit

### Changing your Password

- 1 Use the  $\uparrow$  or  $\downarrow$  buttons to select Change Password and press  $\rightarrow$ .
- 2 Follow steps 1 and 2 for “Using the Parent Menu” on page 29.



### Select a Country

Select U.S.A. to use US ratings (see pages 32-33) or select Canada to use Canadian ratings (see page 34). If you select a Country (U.S.A. or Canada) that is not where you live, the rating you select will not be activated.

- 1 Press  $\downarrow$  to highlight Country, press  $\rightarrow$ .
- 2 Use the  $\uparrow$  or  $\downarrow$  to select the desired country and press  $\rightarrow$ .

### Information for Parents

#### To view a program that exceeds the TV rating

- Press , then use the  buttons to enter your password.

 Entering your password to view a blocked program will temporarily turn Lock to Off. To reactivate your Lock settings, turn the TV off then back on; the TV will return to the settings that you have selected.

### Using the Custom Menu

Follow the instructions on the screen to make your custom settings. Select the country desired for your TV's rating limit. See page 32 for U.S. models and page 34 for Canadian models for more information.

 Once you have blocked a rating or content, all higher ratings or content will be automatically blocked.

## United States: Selecting Custom Rating Options

For the United States, the Custom Rating Menu includes the following options: Movie Rating, TV Rating and Unrated. (For Canada, see page 34.)

### Movie Rating

This system defines the rating levels of movies shown in theaters and on prime cable channels.

Rating	Defined as
<b>G</b>	General audience
<b>PG</b>	Parental Guidance suggested
<b>PG-13</b>	Parents strongly cautioned
<b>R</b>	Restricted
<b>NC-17</b>	No one 17 and under admitted
<b>X</b>	Adult audience only



### TV Rating

The TV rating is divided into two groups: age-based and content-based.

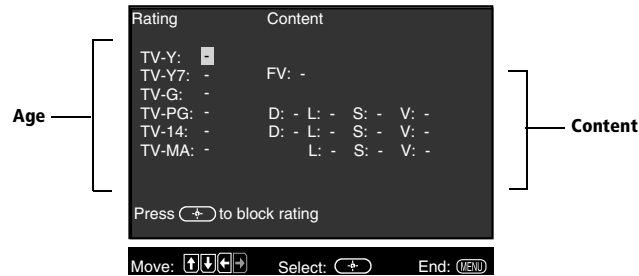

Age	Defined as
<b>TV-Y</b>	All children
<b>TV-Y7</b>	Directed to older children
<b>TV-G</b>	General audience
<b>TV-PG</b>	Parental Guidance suggested
<b>TV-14</b>	Parents strongly cautioned
<b>TV-MA</b>	Mature Audience only

Content	Defined as
<b>FV</b>	Fantasy Violence
<b>D</b>	Suggestive dialogue
<b>L</b>	Strong language
<b>S</b>	Sexual situations
<b>V</b>	Violence

The content ratings will increase depending on the level of the age-based rating. For example, a program with a TV-PG V (Violence) rating may contain moderate violence, while a TV-14 V (Violence) rating may contain intense violence.

## Unrated

You have the option of blocking TV programs or movies that are not rated.

<b>Allow</b>	Allows all unrated programs
<b>Block</b>	Blocks all unrated programs

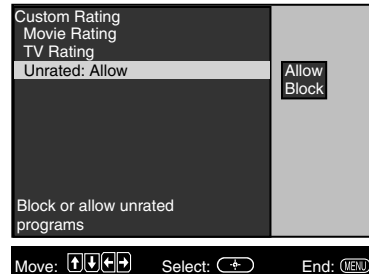

 If you choose to block unrated TV programs, please be aware that the following programs may be blocked: emergency broadcasts, political programs, sports, news, public service announcements, religious programs and weather.

## Canada: Selecting Custom Rating Options

For Canada, the Custom Rating Menu includes the following options: English Rating, French Rating and U.S.A. Rating.

### English Rating

These ratings are for Canadian programs that are broadcast in English.

Rating	Defined as
<b>C</b>	Children
<b>C8+</b>	Children 8 years and older
<b>G</b>	General programming
<b>PG</b>	Parental Guidance
<b>14+</b>	Viewers 14 and older
<b>18+</b>	Adult programming

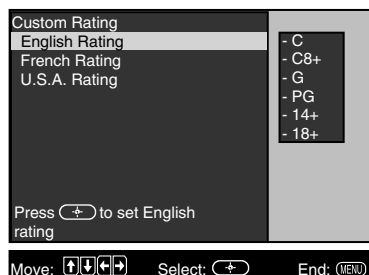

### French Rating

These ratings are for Canadian programs that are broadcast in French.

Rating	Defined as
<b>G</b>	General
<b>8 ans+</b>	Not recommended for younger children
<b>13 ans+</b>	Not recommended for children under age 13
<b>16 ans+</b>	Not recommended for ages under 16
<b>18 ans+</b>	This program is restricted to adults

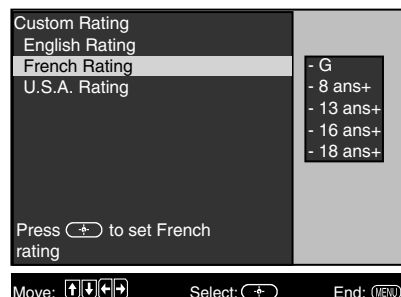

### U.S.A. Rating

For programs from the United States, please see “TV Rating” on page 32.



## Using the Timer Menu

To access the Timer menu, refer to the following steps:

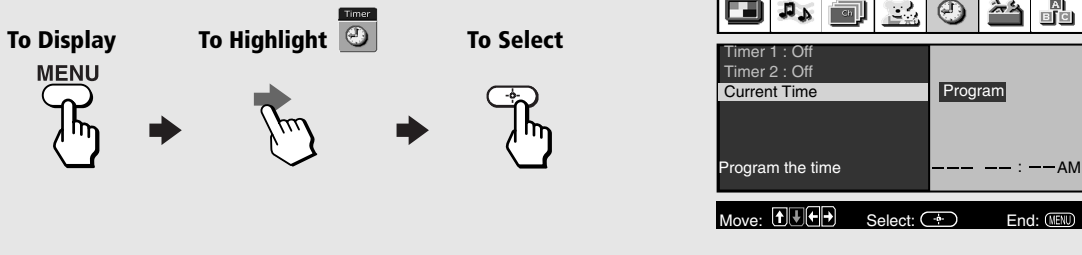

The diagram illustrates the three steps to access the Timer menu:

- To Display:** Press the **MENU** button.
- To Highlight:** Press the right arrow button.
- To Select:** Press the **+** button.

The screenshot shows the TV menu with the **Timer** option highlighted. The menu options are: Video, Audio, Channel, Parent, **Timer**, Setup, and Basic. The Timer menu is open, showing: Timer 1 : Off, Timer 2 : Off, Current Time, and Program. The bottom of the screen shows navigation controls: Move (up, down, left, right arrows), Select (+), and End (MENU).

- Current Time** Set your TV to the current day and time. Press **+** to open Current Time menu:
- 1 Use the **↑** or **↓** buttons to enter the correct day and time, then press **+**.
  - 2 Press **MENU** to exit the menu.

 You must set the Current Time before you can use Timer 1 or Timer 2.

- Timer 1 and Timer 2** Use the timers to program your TV to turn on and off by day, time, duration and channel. The timers duration is maximum of 6 hours. When the channel is fixed, it is not necessary to set the channel.
- Scheduled viewing*
- 1 Use the **↑** or **↓** buttons to select Timer 1 or Timer 2, then press **+**.
  - 2 Use the **↑** or **↓** buttons to enter the desired day, start time, duration, and channel, then press **+**. The timer status should be On when the Timer has been set, and the timer light on the front panel of the TV should be turned on.
  - 3 Press **MENU** to exit the menu.

 Select Off to turn off the Timer (your previous settings will be saved).



 When you perform Auto Program, Timer 1 and Timer 2 settings will be cleared. Also, in the event of any loss of power, Current Time, Timer 1 and Timer 2 settings will be cleared.

## Using the Setup Menu

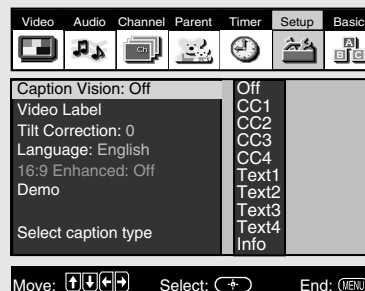
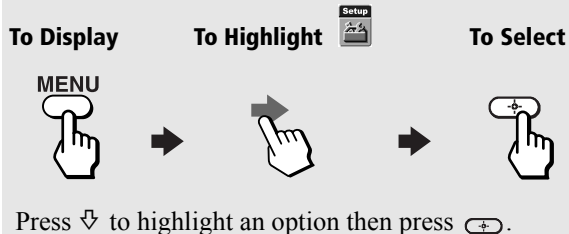
To access the Setup menu, refer to the following steps:











**Caption Vision**  
*Closed-Captioning*

Allows you to select from three closed caption modes (for programs that are broadcast with closed captioning).  
Use the  or  buttons to select from one of the following options, then press  to select it.

**Off:** Caption Vision is not activated.  
**CC1, 2, 3, 4:** Displays printed dialogue and sound effects of a program.  
**Text1, 2, 3, 4:** Displays network/station information.  
**Info:** Displays the name of the current program and its remaining time, if available.



**Video Label**  
*Label connected equipment*

Allows you to identify the audio/video components connected to the TV: VCR, DVD, etc. When you press TV/VIDEO to switch inputs, the Video Label will display on-screen.



- 1 Press  or  buttons to access the input you want to label and press .
- 2 Press  or  buttons to choose a label and press .
- 3 Press  to return to Setup menu or press  to exit.

 If you select "Skip", your TV skips this connection when you press the TV/VIDEO button.

**Tilt Correction**

Use the  or  buttons to correct any tilt of the picture from -5 to +5, then press  to activate.

**Language**

Display all menus in the language of your choice.  
Use the  or  buttons to select from one of the following options: English, Español (Spanish) and Français (French). Then press .

**16:9 Enhanced**

Provides enhanced picture resolution for wide-screen sources such as DVD (only available when the TV is in Video mode).

**Demo**

Press  to run a demonstration of the on-screen menus.

 You can press any key to exit Demo mode.

## Using the Basic Menu

To access the Basic menu, refer to the following steps:

**To Display**





**To Highlight**



**To Select**



Press  to highlight an option then press .

Basic Menu





Picture  Adjust

Caption Vision: Off

Effect: Off







Advanced Menu





Picture white level

Move:    

Select: 

End: 

<b>Picture</b>	Press  to decrease picture contrast.
<i>Picture contrast</i>	Use the  to increase picture contrast.
<b>Caption Vision</b>	In the Basic menu, Caption Vision options are Off and the last captioning option selected (CC1-4, Text1-4, or Info).
<i>Closed-Captioning</i>	
<b>Effect</b>	Use the  or  buttons to select one of the following options, then press  to select it.
<b>Surround:</b>	Simulates theater quality sound for stereo programs.
<b>Off:</b>	Normal stereo or mono reception.
<b>Advanced Menu</b>	Press  to return to the advanced menus.







 If you use the  button to close the Basic menu, only the Basic menu appears when you press  again. To access the other menus, press  to highlight Advanced Menu, then press .



# Other Information

## Programming the Remote Control

You can use the supplied remote control to operate Sony or non-Sony video equipment.

- 1 Press  .
- 2 Press  or  (FUNCTION).
- 3 Use the - buttons to key in the code number from the following chart.
- 4 Press  .

### VCR codes

Sony	301, 302, 303	JCPenney	309, 305, 304, 330, 314, 336, 337
Admiral (M.Ward)	327	JVC	314, 336, 337, 345, 346, 347
Aiwa	338, 344	Kenwood	314, 336, 332, 337
Audio Dynamic	314, 337	LXI (Sears)	332, 305, 330, 335, 338
Broksonic	319, 317	Magnavox	308, 309, 310
Canon	309, 308	Marantz	314, 336, 337
Citizen	332	Marta	332
Craig	302, 332	Memorex	309, 335
Criterion	315	Minolta	305, 304
Curtis Mathis	304, 338, 309	Mitsubishi/MGA	323, 324, 325, 326
Daewoo	341, 312, 309	Multitech	325, 338, 321
DBX	314, 336, 337	NEC	314, 336, 337
Dimensia	304	Olympic	309, 308
Emerson	319, 320, 316, 317, 318, 341	Optimus	327
Fisher	330, 335	Panasonic	308, 309, 306, 307
Funai	338	Pentax	305, 304
General Electric	329, 304, 309	Philco	308, 309
Go Video	322, 339, 340	Philips	308, 309, 310
Goldstar	332	Pioneer	308
Hitachi	306, 304, 305, 338	Quasar	308, 309, 306
Instant Replay	309, 308	RCA/PROSCAN	304, 305, 308, 309, 311, 312, 313, 310, 329
Realistic	309, 330, 328, 335, 324, 338	Symphonic	338
Samsung	322, 313, 321	Tashiro	332
Sansui	314	Tatung	314, 336, 337
Sanyo	330, 335	Teac	314, 336, 338, 337

## Operating Instructions

### VCR codes

Scott	312, 313, 321, 335, 323, 324, 325, 326	Technics	309, 308
Sharp	327, 328	Toshiba	312, 311
Shintom	315	Wards	327, 328, 335, 331, 332
Signature 2000 (M. Ward)	338, 327	Yamaha	314, 330, 336, 337
SV2000	338	Zenith	331
Sylvania	308, 309, 338, 310		

### Cable box codes

Sony	230
Hamlin/Regal	222, 223, 224, 225, 226
Jerrold/G. I.	201, 202, 203, 204, 205, 206, 207, 208, 218
Oak	227, 228, 229
Panasonic	219, 220, 221
Pioneer	214, 215
Scientific Atlanta	209, 210, 211
Tocom	216, 217
Zenith	212, 213

### Laser Disc Player codes

Sony	701
Panasonic	704, 710
Pioneer	702

### DBS codes

DIRECTV	809
Echostar/Dish Network	810

### Satellite receiver codes

Sony	801
General Electric	802
Hitachi	805
Hughes	804
Panasonic	803
RCA/PROSCAN	802, 808
Toshiba	806, 807

### DVD Player codes









Sony	751
JVC	756
Mitsubishi	761
Onkyo	762
Oritron	759
Panasonic	753
Philips/ Magnavox	757
Pioneer	752
RCA	755
Samsung/Hitachi	758
Toshiba	754
Zenith	760

 If more than one code number is listed, try entering them one by one until you come to the correct code for your equipment.









 Whenever you remove the batteries, the code numbers may revert to the factory setting and must be reset.

 In some rare cases, you may not be able to operate your equipment with the supplied remote control. In this case, use the equipment's supplied remote control.





### Operating a VCR

Press	To
	Power on the VCR
	Select channels directly
	Change channels
	Play video tape
	Stop
	Search forward or backward
	Pause
	Record
	Change between VCR and TV inputs

### Operating a DVD

Press	To
	Power on the DVD
	Select chapters directly
	Search chapters forward or backward
	Play DVD
	Stop
	Pause
	Move the cursor in the menu
	Display the DVD menu



### Operating a Laser Disc



Press	To
	Power on the laser disc
	Search chapters forward or backward
	Play disc
	Stop
	Pause



# Troubleshooting

If you are having a problem with your TV, try the suggestions below. If the problem persists, contact your nearest Sony Dealer.

Problem	Possible Solutions
<b>Reset the TV to factory settings</b>	<ul style="list-style-type: none"><li>❑ Turn on the TV. While holding down the RESET button on the remote control, press POWER button on the TV front panel. (The TV will turn itself off, then back on again.) Release the RESET button.</li></ul>
<b>No picture, no sound</b>	<ul style="list-style-type: none"><li>❑ Make sure the power cord is plugged in.</li><li>❑ If a red light is flashing on the front of your TV for more than a few minutes, disconnect and reconnect the power cord to restore the TV. If the problem continues, call your local service center.</li><li>❑ Check the TV/VIDEO setting: when watching TV, set to TV; when watching video equipment, set to VIDEO 1, 2, 3 or 4 (page 4).</li><li>❑ Make sure the batteries have been inserted correctly into the remote control (page 2).</li><li>❑ Try another channel to rule out station trouble.</li></ul>
<b>Poor or no picture, good sound</b>	<ul style="list-style-type: none"><li>❑ Adjust the Picture setting in the Video menu (page 24).</li><li>❑ Adjust the Brightness setting in the Video menu (page 24).</li><li>❑ Check the antenna and/or cable connections (page 7).</li></ul>
<b>Good picture, no sound</b>	<ul style="list-style-type: none"><li>❑ Press  so that Muting disappears from the screen (page 3).</li><li>❑ Check your Audio settings. Your TV may be set to Auto SAP in the MTS feature (page 25).</li><li>❑ Make sure the Speaker option is set to On in the Audio Menu (page 25).</li><li>❑ Press  to adjust your TV's volume, it's probably very low.</li></ul>
<b>No color</b>	<ul style="list-style-type: none"><li>❑ Adjust the Color setting in the Video menu (page 24).</li></ul>
<b>Only snow appears on the screen</b>	<ul style="list-style-type: none"><li>❑ Check the Cable setting in the Channel Setup menu (page 27).</li><li>❑ Check the antenna and/or cable connections (page 7).</li><li>❑ Make sure the channel selected is currently broadcasting.</li></ul>
<b>Dotted lines or stripes</b>	<ul style="list-style-type: none"><li>❑ Adjust the antenna.</li><li>❑ Move the TV away from other electronic equipment. Some electronic equipment creates electrical noise, which can interfere with TV reception.</li></ul>
<b>Double images or ghosts</b>	<ul style="list-style-type: none"><li>❑ Check your outdoor antenna or call your cable service.</li></ul>
<b>Cannot receive higher number channels (UHF) when using an antenna</b>	<ul style="list-style-type: none"><li>❑ Make sure Cable is set to Off in the Channel Setup menu (page 27).</li><li>❑ Perform Auto Program to add channels that are not presently in the memory (page 17).</li></ul>

Problem	Possible Solutions
<b>Cable stations don't seem to work</b>	<ul style="list-style-type: none"> <li><input type="checkbox"/> Make sure Cable is set to On in the Channel Setup menu (page 27).</li> <li><input type="checkbox"/> Perform Auto Program to add channels that are not presently in the memory (page 17).</li> </ul>
<b>Remote control does not operate</b>	<ul style="list-style-type: none"> <li><input type="checkbox"/> Press TV (FUNCTION) when operating your TV.</li> <li><input type="checkbox"/> Check the orientation of the batteries.</li> <li><input type="checkbox"/> Batteries could be weak. Replace them (page 2).</li> <li><input type="checkbox"/> Move the TV three to four feet away from fluorescent lights.</li> </ul>
<b>Cannot change channels with the remote control</b>	<ul style="list-style-type: none"> <li><input type="checkbox"/> Make sure you have not inadvertently switched your TV from the channel 3 or 4 setting if you are using another device to change channels.</li> <li><input type="checkbox"/> If you are using another device to control channels, be sure that you have pressed the FUNCTION button for that device. For example, if you are using your VCR to control channels, be sure to press the VCR/DVD FUNCTION buttons (page 4).</li> </ul>
<b>Cannot access other menus when using the Basic menu</b>	<ul style="list-style-type: none"> <li><input type="checkbox"/> If you use the  button to close the Basic menu, only the Basic menu appears when you press  again. To access the other menus, select the Advanced Menu option (page 37).</li> </ul>
<b>The remote control doesn't work in PIP mode</b>	<ul style="list-style-type: none"> <li><input type="checkbox"/> Press the TV FUNCTION button. You may have inadvertently pressed the VCR/DVD FUNCTION button, which changes the PIP buttons to VCR mode (page 20).</li> </ul>
<b>There is no window picture or it is just static</b>	<ul style="list-style-type: none"> <li><input type="checkbox"/> Be sure your PIP window picture is set to a video source/channel that has a program airing.</li> <li><input type="checkbox"/> You may be tuned to a video input with nothing connected to it. Try cycling through your video inputs using the yellow PIP TV/VIDEO button with the red dot (page 21).</li> </ul>
<b>I get the same program in the window picture as in the main picture</b>	<ul style="list-style-type: none"> <li><input type="checkbox"/> Both may be set to the same channel. Try changing channels in either the main picture or the window picture (page 20).</li> <li><input type="checkbox"/> Your TV may be set up to select all your channels through a cable box. The cable box will only unscramble one signal at a time, so you cannot use the PIP feature. If possible, run a direct cable to the VHF/UHF jack on your TV. This will only work if your cable system provides an unscrambled signal (page 9).</li> </ul>
<b>I cannot get anything but TV</b>	<ul style="list-style-type: none"> <li><input type="checkbox"/> Be sure that you did not set the video label in the Setup menu (page 36) to skip your video inputs. If a video input has been set to "Skip", it will be skipped when pressing the TV/Video buttons for either the main or PIP pictures.</li> </ul>
<b>The TV needs to be cleaned</b>	<ul style="list-style-type: none"> <li><input type="checkbox"/> Clean the TV with a soft dry cloth. Never use strong solvents such as thinner or benzine, which might damage the finish of the cabinet.</li> </ul>

## Operating Instructions

---

<b>Problem</b>	<b>Possible Solutions</b>
<b>Lost password for Parental Control</b>	<input type="checkbox"/> In the password screen, enter the following master password: 4357. After using the master password, you must create a new password. The master password cannot be used to unlock currently blocked channels.
<b>You lost your remote control</b>	<input type="checkbox"/> You can use the front panel controls to access your menus, change channels, adjust the volume or change video inputs (page 2). Contact your nearest Sony Dealer to order a replacement, please call our Sony Direct Accessory and Part Center at 1-800-488-7669 (U.S. residents only).
<b>There is a black box on the screen</b>	<input type="checkbox"/> You have selected a text option in the Setup menu (page 36) and no text is available. To turn off this feature, select Off in the Caption Vision option. If you were trying to select closed captioning, select CC1-4 instead of Text1-4.
<b>TV doesn't turn on after disconnecting the TV and timer LED flashes</b>	<input type="checkbox"/> Press the POWER button on your remote control or in the TV front panel, one more time.

*If, after reading these Operating Instructions, you have additional questions related to the use of your Sony television, please call our Customer Information Services Center at 1-800-222-SONY (7669) (U.S. residents only) or (416) 499-SONY (7669) (Canadian residents only).*

## Specifications

### For all models (except as noted)

Television system	American TV standard/NTSC
Channel coverage	VHF: 2-13/UHF: 14-69/CATV: 1-125
Antenna	75-ohm external antenna terminal for VHF/UHF
Picture tube	FD Trinitron® tube
Power requirements	120V, 60 Hz
Supplied Accessories	Size AA (R6) batteries (2) Remote Control RM-Y180 (1) (KV-27FS100, KV-32FS100, KV-36FS100) Remote Control RM-Y181 (1) (KV-27FS200, KV-32FS200, KV-36FS200)
Optional Accessories	Connecting cables VMC-810S/820S, VMC-720M, YC-YC-15V/30V, RK74A EAC-66U/V mixer TV Stand: SU-27FS1 for KV-27FS100 and KV-27FS200 SU-32FS1 for KV-32FS100 and KV-32FS200 SU-36FS1 for KV-36FS100 and KV-36FS200

### KV-27FS100, KV-27FS200

Screen size	Visible screen size: 679 mm (27 inches) measured diagonally Actual screen size: 736.6 mm (29 inches) measured diagonally		
Inputs/outputs	Inputs	1 video, 1 audio (front) 2 video, 2 audio (rear) 1 S VIDEO 1 RF (KV-27FS100) 2 RF (KV-27FS200) 1 Y, PB,PR, 1 audio	Outputs 1 AUDIO OUT
Speaker output	10 W x 2		
Power Consumption	180 W in use 1 W in stand by (KV-27FS100) 185 W in use 1 W in stand by (KV-27FS200)		
Dimensions (W/H/D)	768 x 589 x 497 mm (30 <sup>1</sup> / <sub>4</sub> x 23 <sup>1</sup> / <sub>4</sub> x 19 <sup>5</sup> / <sub>8</sub> inches)		
Mass	49.5 kg (109 lbs. 2 oz.)		

### KV-32FS100, KV-32FS200

Screen size	Visible screen size: 803 mm (32 inches) measured diagonally Actual screen size: 863.6 mm (34 inches) measured diagonally		
Inputs/outputs	Inputs	1 video, 1 audio (front) 2 video, 2 audio (rear) 1 S VIDEO 1 RF (KV-32FS100) 2 RF (KV-32FS200) 1 Y, PB,PR, 1 audio	Outputs 1 AUDIO OUT
Speaker output	10 W x 2		
Power Consumption	190 W in use 1 W in stand by (KV-32FS100) 195 W in use 1 W in stand by (KV-32FS200)		
Dimensions (W/H/D)	898 x 696 x 576 mm (35 <sup>3</sup> / <sub>8</sub> x 27 <sup>3</sup> / <sub>8</sub> x 22 <sup>5</sup> / <sub>8</sub> inches)		
Mass	75 kg (165 lbs. 6 oz.)		

## Operating Instructions

---

### **KV-36FS100, KV36FS200**

Screen size	Visible screen size: 911 mm (36 inches) measured diagonally Actual screen size: 965.2 mm (38 inches) measured diagonally	
Inputs/outputs	Inputs	Outputs
	1 video, 1 audio (front)	1 AUDIO OUT
	2 video, 2 audio (rear)	
	1 S VIDEO	
	1 RF (KV-36FS100)	
	2 RF (KV-36FS200)	
	1 Y, PB,PR, 1 audio	
Speaker output	10 W x 2	
Power Consumption	190 W in use 1 W in stand by (KV-36FS100) 195 W in use 1 W in stand by (KV-36FS200)	
Dimensions (W/H/D)	985 x 774 x 633 mm (38 <sup>3</sup> / <sub>4</sub> x 30 <sup>1</sup> / <sub>2</sub> x 25 inches)	
Mass	98.4 kg (216 lbs. 8 oz.)	

*Design and specifications are subject to change without notice.*

# Index

- 16:9 Enhanced **36**
- A**
  - Audio Out **26**
  - Auto Program **17, 28**
  - Auto SAP **25**
- B**
  - Balance **25**
  - Bass **25**
  - Batteries
    - Inserting in remote **2**
  - Brightness **24**
- C**
  - Cable **27**
  - Caption Vision **36**
  - Channel Fix **27**
  - Channel Label **28**
  - Channel Skip/Add **28**
  - Color **24**
  - Color Temperature **24**
  - Connections
    - Cable and antenna **7**
    - Cable Box and Cable **9**
    - Connecting a Camcorder **15**
    - Connecting a DVD Player **14**
    - Connecting an Audio System **15**
    - TV and Cable Box **8**
    - TV and Satellite Receiver **12**
    - TV and VCR **10**
    - TV, Satellite Receiver and VCR **13**
    - TV, VCR and Cable Box **11**
  - Current Time **35**
- D**
  - Demo **36**
  - DISPLAY **4**
- E**
  - Effect
    - Off **25**
    - Surround **25**
- F**
  - Favorite Channels **27**
- H**
  - Hue **24**
- L**
  - Language **36**
- M**
  - Menus
    - Audio **25**
    - Basic **37**
    - Channel Setup **27**
    - Parent **29**
    - Setup **36**
    - Timer **35**
    - Video **24**
  - Mode
    - Movie **24**
    - Sports **24**
    - Standard **24**
    - Vivid **24**
  - MTS
    - Auto SAP **25**
    - Mono **25**
    - Stereo **25**
- P**
  - Parental Control **30**
  - Picture **24, 37**
  - Picture in Picture (PIP) **20**
- R**
  - Ratings
    - English Rating **34**
    - French Rating **34**
    - Movie Rating **32**
    - TV Rating **32**
    - U.S.A. Rating **34**
    - Unrated **33**
  - Remote Control
    - Batteries **2**
    - Programming **39**
    - Using **3, 4**
- S**
  - Setting the Rating **30**
  - Sharpness **24**
  - SLEEP **3**
  - Speaker **25**
  - Specifications **45**

**T**

- Tilt Correction **36**
- Timer 1 and Timer 2 **35**
- Treble **25**
- Troubleshooting **42**
- TV Features **1**
- TV Front Panel **2**
- TV Rear Panel **5**

**V**

- V-Chip (see Parental Control)
- Video Label **36**
- VM **24**

















Sony Corporation

Printed in U.S.A.

**SONY**<sup>®</sup>

4-089-081-31



**FD Trinitron**  
**WEGA**<sup>®</sup>

---

Mode d'emploi

KV-27FS100  
KV-32FS100  
KV-36FS100

© 2002 par Sony Corporation





# AVERTISSEMENT

Afin d'éviter tout risque d'incendie ou d'électrocution, ne pas exposer cet appareil à la pluie ou à l'humidité.

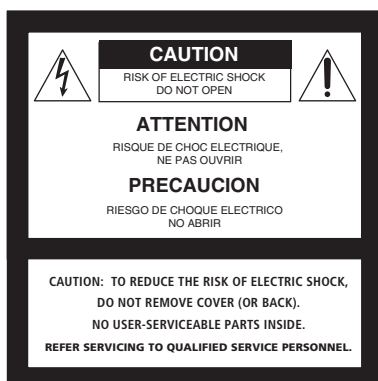

Ce sigle vise à signaler à l'utilisateur la présence d'une "tension dangereuse" non isolée au sein de l'appareil, dont la puissance peut être suffisante pour provoquer un risque d'électrocution.



Ce sigle vise à signaler à l'utilisateur la présence d'une documentation importante concernant les instructions de fonctionnement et d'entretien de cet appareil.

## Remarque aux installateurs du système de télévision par câble

L'attention des installateurs du système de télévision par câble est attirée sur l'article 820-40 du NEC (National Electrical Code - États-unis) qui énonce les directives concernant le raccordement à la masse, stipulant en particulier qu'il doit être branché à celui de l'immeuble (ou maison), et aussi proche que possible du point d'entrée du câble.

## PRECAUTIONS DE SECURITE

- N'utiliser l'appareil que sur du courant alternatif 120 V.
- L'une des lames de la fiche est plus large que l'autre pour des raisons de sécurité et ne s'adapte dans la prise que dans un seul sens. Consultez votre revendeur si vous ne parvenez pas à brancher la fiche totalement.
- Si un liquide ou un objet quelconque venait à s'introduire dans l'appareil, débranchez immédiatement le cordon d'alimentation et faites vérifier le téléviseur par un technicien qualifié avant de le remettre en service.

## ATTENTION

Lorsque vous utilisez des jeux, des ordinateurs et d'autres appareils similaires avec votre téléviseur, réglez la brillance et le contraste à des valeurs basses. Une image restant fixe sur l'écran pendant un temps prolongé peut s'y imprimer en permanence lorsque la brillance ou le contraste sont trop élevés. De même, la visualisation continue d'un même canal peut provoquer l'impression du logo du canal. Ces impressions ne sont pas couvertes par votre garantie car elles résultent d'une utilisation incorrecte du téléviseur.



Pour éviter tout risque d'électrocution, n'utilisez pas cette fiche d'alimentation secteur polarisée avec une rallonge, une prise de courant ou avec une autre prise si les lames ne peuvent être introduites complètement afin d'éviter que des parties de lame nue restent exposées.



Vous êtes averti que tout changement ou modification non expressément approuvé dans le présent mode d'emploi peut invalider votre droit à utiliser cet appareil.

## AVIS

Cet appareil a été testé et approuvé en conformité avec les limites qui définissent un appareil numérique de classe B suivant la partie 15 des règlements du Centre de contrôle des fréquences (FCC). Ces limites sont conçues pour assurer une protection raisonnable pour une installation en résidence privée.

Cet appareil génère, utilise, et peut émettre, de l'énergie sur les fréquences radios, et, s'il n'est pas utilisé en suivant les instructions, peut causer des interférences nuisibles aux communications radio. Cependant, il n'y a pas de garantie qu'aucune interférence ne sera produite dans une installation particulière. Si cet appareil cause une interférence nuisible à la réception de la radio ou de la télévision, ce qu'on peut déterminer en éteignant et en rallumant l'appareil, l'utilisateur est encouragé à réduire l'interférence par les mesures suivantes :

- Ré-orienter ou déplacer les antennes réceptrices.
- Augmenter la distance entre l'appareil et le récepteur.
- Brancher l'appareil sur une prise différente de celle où est branché le récepteur.
- Consulter et se faire aider par le revendeur ou un technicien radio/télévision expérimenté.

## Protection du téléviseur

- Pour éviter toute surchauffe interne, évitez de boucher les orifices de ventilation.
- N'installez pas l'appareil dans un endroit surchauffé, trop humide, poussiéreux, ou soumis à des vibrations mécaniques excessives.

## Remarque sur l'affichage des sous-titres d'image

Ce téléviseur permet d'afficher les sous-titres d'image en accordance avec § 15.119 des règlements du Centre de contrôle des fréquences (FCC).

L'utilisation de ce téléviseur à d'autres fins qu'une vue par des particuliers des émissions transmises par les canaux UHF ou VHF ou par des sociétés de câble pour le grand public peut nécessiter l'accord de ces sociétés ou du propriétaire de l'émission.

## Références utilisateur

Les numéros de modèle et de série sont situés sur la couverture avant du présent mode d'emploi et à l'arrière du téléviseur.

## Marques commerciales et droits d'auteur

ENERGY STAR® est une marque déposée aux États-unis.



Comme associé au programme ENERGY STAR®, Sony a déterminé que ce produit ou ces modèles de produit satisfaisaient aux critères d'efficacité et de conservation de l'énergie posés par les directives ENERGY STAR®.

WEGA, FD Trinitron et Caption Vision sont des marques déposées de Sony Corporation.

## Consignes de sécurité importantes

Pour votre protection, veuillez lire entièrement ces instructions et les conserver à toutes fins utiles. Observez et respectez scrupuleusement tous les avertissements, précautions et instructions spécifiés sur l'appareil, ou décrits dans le mode d'emploi ou le manuel d'entretien.

### AVERTISSEMENT

Pour éviter tout risque de blessure, veuillez respecter les précautions de sécurité élémentaires suivantes lors de l'installation, l'utilisation et la réparation de l'appareil.

### Utilisation

#### Sources d'alimentation

Cet appareil ne doit être alimenté que sur le type de source d'alimentation indiqué sur la plaque du numéro de série/modèle. Si vous n'êtes pas sûr du type d'alimentation électrique de votre domicile, consultez votre revendeur ou la société locale de distribution électrique. En ce qui concerne les appareils conçus pour fonctionner sur une alimentation par batterie, reportez-vous au mode d'emploi.



#### Mise à la terre ou polarisation

Cet appareil est équipé d'une fiche d'alimentation secteur polarisée (une lame de la fiche est plus large que l'autre) ou d'une fiche à trois broches avec fil de terre (la troisième broche sert pour la mise à la terre).

Suivez les instructions ci-dessous:

#### Pour un appareil équipé d'une fiche d'alimentation secteur polarisée

Cette fiche ne se branche sur la prise secteur que d'une seule manière. C'est un dispositif de sécurité. Si vous ne parvenez pas à enfoncer la fiche à fond dans la prise, essayez de la retourner. Si la fiche ne correspond toujours pas, contactez votre électricien pour faire poser une prise adéquate. N'annulez pas le dispositif de sécurité de la prise polarisée en forçant dessus.



#### Avertissement alternatif

#### Pour un appareil équipé d'une fiche secteur à trois broches

Cette fiche ne peut être insérée que dans une prise secteur avec mise à la terre. C'est un dispositif de sécurité. Si vous ne parvenez pas à insérer la fiche dans la prise, contactez votre électricien pour faire poser une prise adéquate. N'annulez pas le dispositif de sécurité de la fiche de terre.

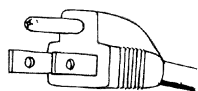

### Surcharge

Ne surchargez pas les prises murales, les rallonges ou autres prises de courant au-delà de leur capacité, car il y a risque d'incendie ou d'électrocution.

Mettez toujours l'appareil hors tension lorsqu'il n'est pas utilisé. Si vous n'avez pas l'intention de

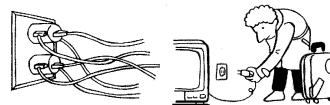

l'utiliser pendant longtemps, débranchez-le de la prise murale, par précaution, pour éviter la possibilité qu'une anomalie interne crée un début d'incendie.

Ne débranchez pas le câble d'antenne ou le cordon d'alimentation pendant un violent orage. La foudre pourrait en effet vous frapper alors que vous tenez le câble ou le cordon et vous causer ainsi de graves blessures. Mettez le téléviseur hors tension et attendez que l'orage passe.

### Pénétration d'un corps solide ou liquide

N'enfoncez jamais un objet quel qu'il soit dans le téléviseur par les fentes d'aération car il pourrait toucher des points de haute tension ou court-circuiter des pièces, et provoquer ainsi un incendie ou une électrocution. Ne renversez jamais de liquide quel qu'il soit dans l'appareil.



### Raccordements

N'utilisez pas de cordons qui ne sont pas recommandés par le fabricant, car ils pourraient être dangereux.

Ne posez pas d'objets, et tout spécialement des objets lourds sur le téléviseur. Ces objets pourraient tomber et vous blesser ou blesser une autre personne.

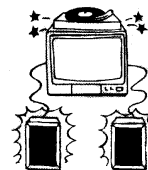

### Nettoyage

Débranchez la fiche de la prise murale avant de nettoyer ou de lustrer l'appareil.

N'utilisez pas de nettoyant liquide ou en vaporisateur. Nettoyez l'extérieur de l'appareil avec un chiffon légèrement humidifié à l'eau.



Si l'appareil produit continuellement ou fréquemment des bruits de claquement ou des bruits secs pendant son fonctionnement, débranchez-le et consultez votre revendeur ou un réparateur. Certains téléviseurs font entendre occasionnellement des bruits de claquement ou des bruits secs, en particulier au moment de la mise sous ou hors tension, mais c'est tout à fait normal.



## Installation

Demandez toujours l'assistance d'une autre ou de plusieurs autres personnes pour soulever ou déplacer le téléviseur. Le téléviseur est lourd et offre peu de prise dans sa partie inférieure. Vous pourriez vous blesser gravement si vous essayez de déplacer le téléviseur seul ou si vous le manipulez de manière instable.

Installez le téléviseur sur une surface stable et de niveau.

## Attention à l'eau et à l'humidité

N'utilisez pas un appareil alimenté sur le secteur près de lieux où se trouve de l'eau, comme une baignoire, un lavabo, un évier ou un bac à laver, dans un sous-sol humide ou près d'une piscine, etc.

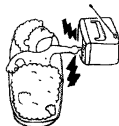

## Accessoires

Ne posez pas l'appareil sur un chariot, un support, une table ou une étagère instable. Il risque de tomber et de blesser gravement un enfant ou un adulte, et l'appareil risque d'être sérieusement endommagé. N'utilisez qu'un chariot ou un support recommandé par le fabricant pour ce modèle de téléviseur.

Pour déplacer un téléviseur placé sur un chariot, poussez-le avec précaution. L'ensemble chariot-téléviseur risque de se renverser en cas d'arrêt brusque, de poussée excessive ou de surface inégale.

Débranchez tous les câbles et tous les cordons avant d'essayer de déplacer le téléviseur.



Ne laissez pas des enfants ou des animaux domestiques monter sur le téléviseur ou le pousser. Le téléviseur pourrait en effet tomber, risquant ainsi de vous blesser sérieusement.

## Ventilation

Les fentes et les ouvertures aménagées sur le coffret et au dos ou au bas de l'appareil sont prévues pour la ventilation nécessaire. Pour assurer un fonctionnement fiable et pour protéger le téléviseur d'une surchauffe, ces fentes et ouvertures ne doivent jamais être bloquées ou recouvertes.

- Ne couvrez jamais les fentes et les ouvertures avec un chiffon ou autre morceau de tissu.

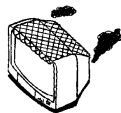

- Ne bloquez jamais les fentes et ouvertures en plaçant l'appareil sur un lit, un canapé, un tapis ou autre surface similaire.

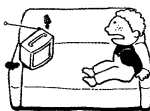

- N'encastrez jamais l'appareil dans un endroit fermé, comme une bibliothèque ou un meuble, sauf si une ventilation adéquate est assurée.



- Ne posez pas l'appareil sur ou près d'un radiateur ou d'un système de chauffage, ou dans un endroit exposé au soleil.



## Protection du cordon d'alimentation

Ne laissez jamais un objet rouler sur le cordon d'alimentation ou poser un objet lourd dessus. N'installez pas l'appareil dans un endroit où le cordon d'alimentation pourrait s'user prématurément ou être endommagé.



## Mise à la masse ou polarisation

Ce téléviseur peut être équipé d'une prise polarisée pour courant alternatif (une prise équipée de deux plots de largeur inégale). Cette prise ne peut être branchée sur le secteur que d'une seule façon. Il s'agit d'une fonction de sécurité. Si vous n'arrivez pas à brancher la prise complètement, retournez-la et essayez à nouveau. Si la prise ne peut toujours pas être branchée, contactez un électricien pour qu'il remplace la prise murale.

Ne désactivez pas la fonction de sécurité de la prise polarisée.

## Antennes

### Mise à la terre de l'antenne extérieure

Si vous installez une antenne extérieure, veuillez respecter les précautions ci-dessous. Une antenne extérieure ne doit pas être installée près de lignes électriques aériennes ou autres circuits d'alimentation ou d'éclairage électriques, ou dans un endroit où elle pourrait toucher de tels circuits ou lignes.

LORS DE L'INSTALLATION D'UNE ANTENNE EXTÉRIEURE, SOYEZ EXTRÊMEMENT PRUDENT POUR ÉVITER DE TOUCHER DE TELS CIRCUITS OU LIGNES ÉLECTRIQUES, CAR UN TEL CONTACT ENTRAÎNE PRATIQUEMENT TOUJOURS LA MORT.

L'antenne doit être reliée à la terre par mesure de sécurité contre les hausses brusques de tension et l'électricité statique accumulée. La section 810 du National Electrical Code (NEC) aux États-Unis et la section 54 du Code canadien de l'électricité fournissent des informations sur le raccordement à la terre correct du mât et de la structure porteuse, le raccordement de la descente d'antenne à une unité de déchargement d'antenne, la taille des conducteurs de mise à la terre, l'emplacement de l'unité de décharge d'antenne, la connexion aux électrodes de terre, et les spécifications des électrodes de terre.

## Mise à la terre de l'antenne conformément au NEC

Reportez-vous à la section 54-300 du Code canadien de l'électricité en ce qui concerne la mise à la terre de l'antenne.

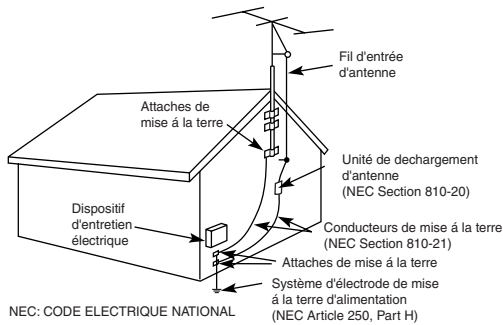

## Foudre

Pour une protection supplémentaire de cet appareil récepteur de télévision durant les orages accompagnés de foudre, ou lorsque l'appareil doit rester sans surveillance et sans usage pour des périodes prolongées, débranchez-le de sa prise murale et déconnectez l'antenne. Ceci évitera l'endommagement de l'appareil causé par la foudre et les surtensions.

## Dépannage

### Domages nécessitant un dépannage

Débranchez l'appareil de la prise murale et faites-le réparer par un réparateur qualifié dans les cas suivants:

- Le cordon ou la fiche d'alimentation est abîmé ou dénudé.

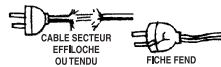

- Du liquide s'est renversé dans l'appareil ou des objets sont tombés dedans.

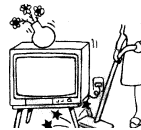

- L'appareil a été mouillé ou exposé à la pluie.



- L'appareil est tombé et a été cogné violemment, ou bien le coffret est abîmé.

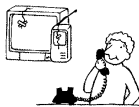

- L'appareil ne fonctionne pas normalement alors que vous avez respecté toutes les instructions du mode d'emploi. N'agissez que sur les commandes spécifiées dans le mode d'emploi. Tout réglage incorrect d'une autre commande risque d'endommager l'appareil et de nécessiter un important travail par un technicien qualifié pour le réparer.

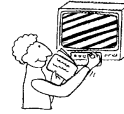

- Une baisse sensible des performances indique que l'appareil a besoin d'être réparé.

## Réparation

N'essayez pas de réparer l'appareil vous-même; vous risquez d'être exposé à des hautes tensions dangereuses ou autres risques en ouvrant le coffret. Pour toute réparation, adressez-vous à un réparateur qualifié.

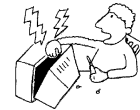

## Remplacement des pièces

Si des pièces doivent être remplacées, n'oubliez pas de demander au réparateur d'attester par écrit qu'il a utilisé des pièces de rechange spécifiées par le fabricant, avec les mêmes caractéristiques que les pièces originales. Toute substitution non autorisée peut être la cause d'un incendie, d'une électrocution ou autre danger.



## Révision de sécurité

A l'occasion de tout dépannage ou réparation de l'appareil, demandez au réparateur d'effectuer une révision de sécurité de routine (comme spécifié par le fabricant) pour déterminer si l'appareil offre une bonne sécurité de fonctionnement, et faites-le certifier par écrit. Lorsque l'appareil atteint la fin de sa vie utile, ne le jetez pas n'importe comment car il y a risque d'implosion du tube image. Demandez à un réparateur qualifié de vous en débarrasser.



# Table des matières

## Introduction

Caractéristiques du téléviseur couleur FD Trinitron WEGA® .....	1
À propos de ce mode d'emploi.....	2
Piles de la télécommande .....	2
Commandes de menu du panneau avant .....	2
Utilisation de la télécommande .....	3

## Raccordement du téléviseur

Panneau arrière du téléviseur .....	7
Raccordements de base .....	8
Raccordement d'autres appareils .....	9

## Utilisation des fonctions de base

Réglage automatique du téléviseur.....	17
Accès rapide aux menus .....	18

## Utilisation des menus

Comment accéder aux menus.....	21
Utilisation du menu Vidéo.....	22
Utilisation du menu Audio .....	23
Utilisation du menu Réglage des canaux.....	25
Utilisation du menu Parent .....	27
Utilisation du menu Heure.....	33
Utilisation du menu Réglage.....	34
Utilisation du Menu de base .....	35

## Informations complémentaires

Programmation de la télécommande.....	37
Guide de dépannage .....	40
Spécifications .....	43

<b>Index</b> .....	45
--------------------	----



# Introduction

Nous vous remercions d'avoir fait l'achat d'un téléviseur couleur FD Trinitron WEGA® Sony. Avant d'utiliser le présent manuel, vérifiez le numéro du modèle indiqué à l'arrière de votre téléviseur ou sur la page de garde du manuel.

## Caractéristiques du téléviseur couleur FD Trinitron WEGA®

Le téléviseur vous offre, entre autres, les fonctions suivantes :

- ❑ **FD Trinitron ECRAN PLAT** — Tube image à la pointe de la technologie offrant une image d'une précision et d'une netteté exceptionnelles.
- ❑ **Entrées Y, Pb, Pr** — Raccordement d'entrée de composant vidéo fournissant une excellente qualité d'image (480i seulement).
- ❑ **Ambiophonie** — Simule un son d'une qualité tridimensionnelle pour les programmes en stéréo.
- ❑ **Contrôle parental (V-Chip)** — Outil aidant les parents à contrôler les émissions que leurs enfants regardent en définissant des limites de classement.
- ❑ **Canaux préférés** — Accès immédiat à vos canaux préférés en appuyant sur une touche.
- ❑ **Bannière info** — Nouvelle fonction pratique permettant d'afficher le nom et la durée restante du programme en cour, lorsque ces informations sont disponibles.
- ❑ **Télécommande universelle** — Programmez votre télécommande pour faire fonctionner le décodeur, le magnétoscope, le récepteur satellite numérique ou le lecteur DVD raccordé.
- ❑ **Energy Star®** — Répond aux critères Energy Star en matière d'économie d'énergie.
- ❑ **Commandes du panneau avant** — Permettent d'accéder aux menus d'écran sans la télécommande.
- ❑ **Entrées A/V avant** — Connexion rapide pour les consoles de jeux vidéo, caméscopes, appareils stéréo/mono.





### À propos de ce mode d'emploi

Le présent mode d'emploi fournit des instructions qui vous permettront d'exploiter au mieux votre nouveau téléviseur. Il décrit comment le raccorder à une antenne ou au réseau câblé, à un décodeur, un magnétoscope, un lecteur DVD, un récepteur satellite, une chaîne stéréo ou à un caméscope. Lorsque les connexions ont été établies, suivez les instructions et utilisez la télécommande pour accéder aux menus affichés.

### Piles de la télécommande

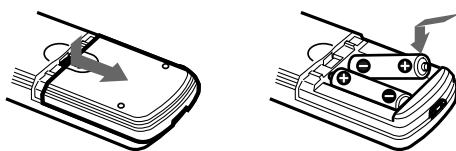
Insérez deux piles AA (R6) (fournies) dans la télécommande en suivant les instructions de l'illustration ci-dessous.





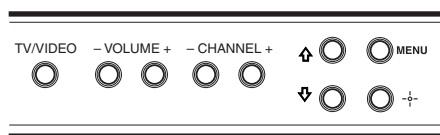

 Dans des conditions d'utilisation normales, les piles durent six mois. Si la télécommande ne fonctionne pas correctement, les piles sont peut-être à plat.

 Si vous n'utilisez pas la télécommande pendant une durée prolongée, retirez les piles afin d'éviter une détérioration éventuelle due à une fuite des piles.

### Commandes de menu du panneau avant



Les commandes du panneau audio/vidéo avant permettent d'accéder au menu sans la télécommande.

- Appuyez sur  pour afficher le menu à l'écran.
- Utilisez les touches  et  du panneau avant au lieu des touches de la télécommande.
- Utilisez la touche  du panneau audio/vidéo avant pour naviguer dans le menu, puis sélectionnez un paramètre.

Les commandes du panneau avant permettent également de changer de canal (CH+/-), de régler le volume (VOL +/-) et de modifier les entrées vidéo.





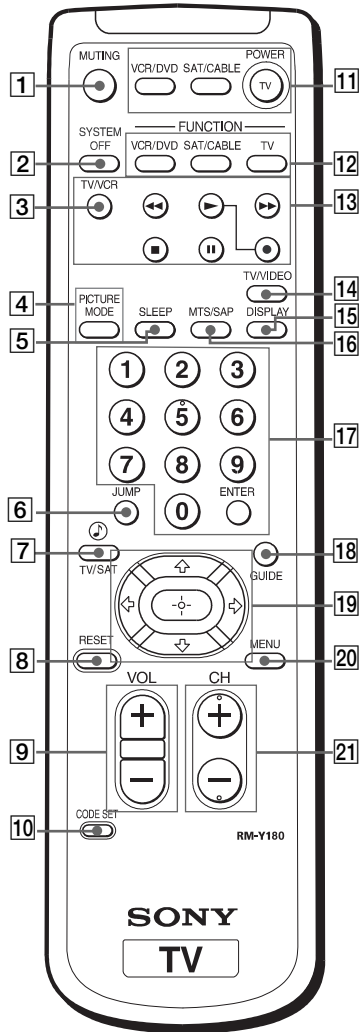

 Reportez-vous à la section " Utilisation des menus ", page 21 pour naviguer entre les menus avec votre télécommande.

## Utilisation de la télécommande

Touche	Description
<b>1</b> MUTING	Appuyez sur cette touche pour désactiver le son. Appuyez de nouveau ou appuyez sur  pour réactiver le son.
<b>2</b> SYSTEM OFF	Appuyez sur cette touche pour mettre hors tension les appareils programmés dans la télécommande. Voir la section "Programmation de la télécommande" à la page 37.
<b>3</b> TV/VCR	Appuyez sur cette touche pour passer du mode téléviseur au mode magnétoscope et vice-versa. Si le magnétoscope n'est pas de marque Sony, il est nécessaire de programmer la télécommande pour qu'elle reconnaisse le magnétoscope. Pour plus de détails, voir "Programmation de la télécommande" à la page 37.
<b>4</b> PICTURE MODE	Appuyez plusieurs fois sur cette touche pour passer en revue les modes image disponibles : éclatant, standard, film et sports. Cette fonction est également offerte par le menu Vidéo. Pour plus de détails, voir "Utilisation du menu Vidéo" à la page 22.
<b>5</b> SLEEP	Appuyez plusieurs fois sur cette touche jusqu'à ce que le délai souhaité de mise hors tension automatique du téléviseur (15, 30, 45, 60 ou 90 minutes) s'affiche à l'écran. Pour annuler, appuyez sur cette touche jusqu'à ce que "Sleep Non" s'affiche. Si la fonction Sleep est active, appuyez une fois sur la touche pour connaître le temps qu'il reste avant que le téléviseur s'éteigne.
<b>6</b> JUMP	Appuyez sur cette touche pour sauter d'un canal à un autre. Le téléviseur alternera entre le canal courant et le dernier canal sélectionné.
<b>7</b> TV/SAT	Appuyez sur cette touche pour commuter la source entre l'entrée téléviseur (TV) et l'entrée satellite (SAT) en mode FUNCTION SAT.



## Mode d'emploi

Touche	Description
	Appuyez sur cette touche pour sélectionner directement le réglage "Effet" (Ambiophonie, Non) lorsque la télécommande est en mode FUNCTION TV. Pour plus de détails, voir "Utilisation du menu Audio" à la page 23.
<b>8</b> RESET	Appuyez sur cette touche pour réinitialiser le téléviseur aux réglages d'origine pendant l'affichage d'un menu à l'écran.
<b>9</b> VOL (volume)	Appuyez sur (+) ou (-) pour régler le volume.
<b>10</b> CODE SET	Utilisez cette touche pour programmer la télécommande afin de commander un appareil vidéo raccordé. Voir "Programmation de la télécommande" à la page 37.
<b>11</b> Touches POWER	Appuyez sur ces touches pour allumer et éteindre le téléviseur et les autres appareils audio et vidéo raccordés programmés dans la télécommande. Pour les directives, reportez-vous à la section "Programmation de la télécommande" à la page 37.
<b>12</b> Touches FUNCTION	Appuyez sur l'une de ces touches pour sélectionner l'appareil à commander avec la télécommande (TV, VCR/DVD, SAT/CABLE). Le indicateur (LED) s'allume momentanément lorsque la touche est enfoncée pour indiquer l'appareil commandé par la télécommande.
<b>13</b> VCR (commande)	Permet de commander votre magnétoscope. Le magnétoscope doit être programmé dans la télécommande. Pour les directives, reportez-vous à la section "Programmation de la télécommande" à la page 37.
REC	Appuyez simultanément sur la touche  et sur la touche  , située en haut et à gauche, pour lancer l'enregistrement de n'importe quelle émission avec votre magnétoscope (la télécommande doit être programmée pour que l'enregistrement fonctionne).
	Appuyez sur cette touche pour rembobiner la cassette.
	Appuyez sur cette touche pour avancer rapidement.
	Appuyez sur cette touche pour lancer la lecture.
	Appuyez sur cette touche pour arrêter la bande.

Touche	Description
<b>II</b>	Appuyez sur cette touche pour faire une pause de lecture. Appuyez de nouveau pour revenir à la lecture normale.
<b>14 TV/VIDEO</b>	Appuyez sur cette touche pour passer d'une source vidéo à l'autre.
<b>15 DISPLAY</b>	Appuyez une fois sur cette touche pour afficher l'heure, le numéro du canal, l'identification du canal (si définie), la source vidéo et l'identification vidéo. Appuyez de nouveau pour désactiver l'affichage.
<b>16 MTS/SAP</b>	Appuyez sur cette touche pour passer en revue les options de la fonction son TV multicanal (MTS) : Stéréo, Auto SAP (bande sonore secondaire) et Mono.
<b>17 0-9 et ENTER</b>	Appuyez sur ces touches pour passer directement à un autre canal. Le canal change après deux secondes.
<b>18 GUIDE</b>	Appuyez sur cette touche pour afficher le guide de programmation de votre service de télé par satellite.
<b>19</b> 	Appuyez sur les touches fléchées pour déplacer le curseur dans les menus à l'écran. Appuyez sur la touche du centre pour sélectionner ou valider une option.
<b>20 MENU</b>	Appuyez sur cette touche pour afficher le menu à l'écran. Pour quitter le menu, appuyez de nouveau sur cette touche, à n'importe quel moment.
<b>21 CH (canal)</b>	Appuyez sur ces touches pour changer de canal. Pour passer rapidement les canaux en revue, maintenez enfoncée la touche CH+ ou CH-.

 Si vous perdez votre télécommande, reportez-vous à la page 42.



# Raccordement du téléviseur

Lisez cette section avant de configurer votre téléviseur pour la première fois. Elle traite les raccordements de base, en plus des appareils en option que vous raccorderez éventuellement.

## Panneau arrière du téléviseur

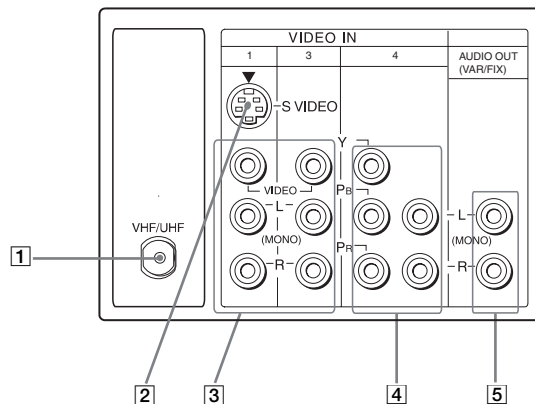



Prise	Description
<b>1 VHF/UHF</b>	Se raccorde sur votre câble ou antenne VHF/UHF.
<b>2 S VIDEO</b>	Se raccorde sur la prise S VIDEO OUT de votre magnétoscope ou d'un autre appareil vidéo possédant une prise S VIDEO. La prise S VIDEO fournit une image de meilleure qualité que les prises VHF/UHF ou que la prise d'entrée vidéo. La prise S VIDEO ne fournit aucun son. Les câbles audio doivent rester raccordés.
<b>3 AUDIO L(MONO), R/ VIDEO</b>	Permet le raccordement aux prises AUDIO/VIDEO OUT du magnétoscope ou d'un autre appareil vidéo. Une troisième prise d'entrée vidéo (VIDEO 2) est située sur le panneau avant du téléviseur. Ces prises d'entrée AUDIO/VIDEO offrent une image de meilleure qualité que la prise VHF/UHF.
<b>4 Y, Pb, Pr/L, R</b>	Se raccorde sur le composant vidéo Y, Pb, Pr vers les prises AUDIO L(MONO) et R de votre lecteur DVD ou décodeur numérique (480i uniquement).
<b>5 AUDIO OUT (VAR/FIX) L(MONO), R</b>	Se raccorde aux prises d'entrée AUDIO L(MONO) et R de votre appareil audio. Vous pouvez écouter le son du téléviseur par l'intermédiaire de votre chaîne stéréo.

## Raccordements de base

### Antenne de télévision intérieure ou extérieure ou câble CATV

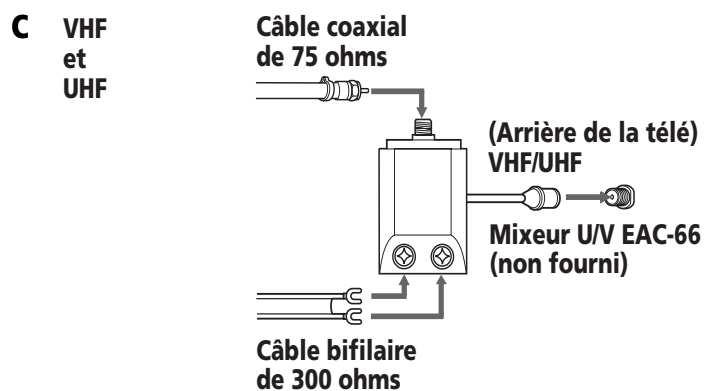
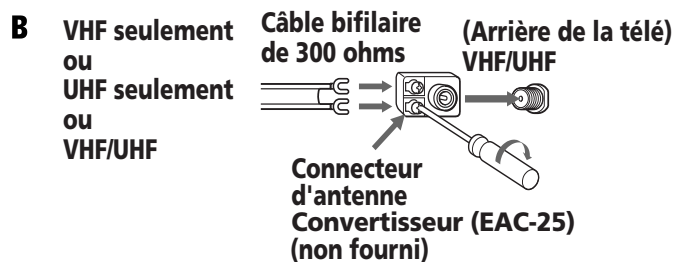
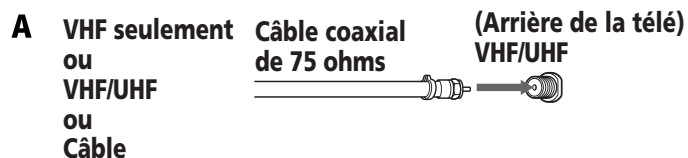
Selon le câble disponible chez vous, choisissez l'un des raccordements suivants



 Si vous vous raccordez sur une antenne intérieure ou extérieure, vous devrez éventuellement ajuster l'orientation de l'antenne pour améliorer la réception.

## Raccordement d'autres appareils

### Raccordement du téléviseur à un magnétoscope

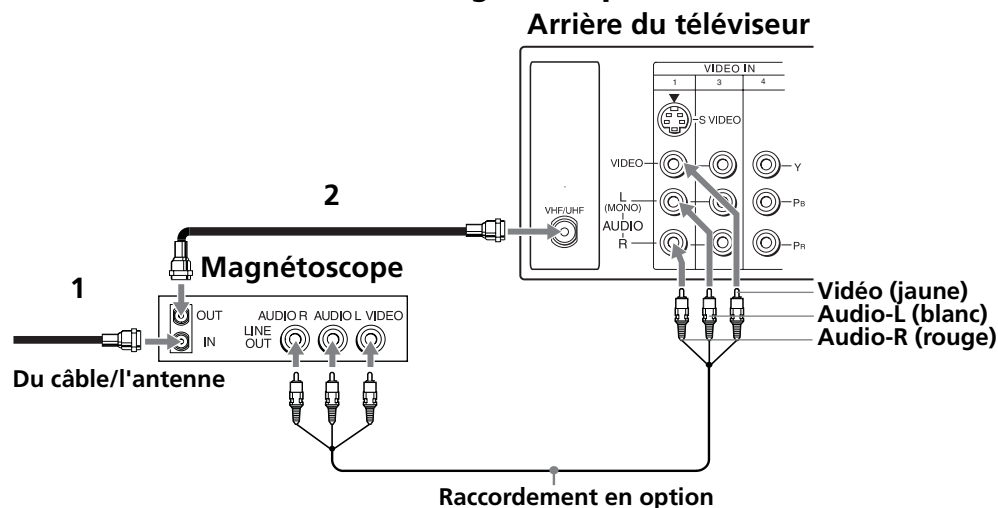

✎ Pour regarder des programmes vidéo depuis le magnétoscope, réglez votre téléviseur sur le canal 3 ou 4 (voir le réglage à l'arrière de votre magnétoscope).

- 1** Raccordez le câble coaxial entre l'antenne de télévision ou le câble et la prise IN du magnétoscope.
- 2** Raccordez un câble coaxial (non fourni) entre la prise OUT du magnétoscope et la prise VHF/UHF du téléviseur.

#### Raccordement en option

Si votre magnétoscope est équipé de sorties vidéo, vous obtiendrez des images de meilleure qualité en raccordant des câbles audio/vidéo (non fournis) entre les prises AUDIO/VIDEO OUT du magnétoscope sur la prise AUDIO/VIDEO IN du téléviseur.

✎ Vous pouvez utiliser la touche  $\text{TV/VIDEO}$  pour basculer entre les entrées VHF/UHF et VIDEO.

✎ Utilisez la prise S VIDEO au lieu du câble vidéo jaune pour obtenir des images de meilleure qualité. La prise S VIDEO ne fournit aucun son. Les câbles audio doivent rester raccordés.



## Décodeur et téléviseur

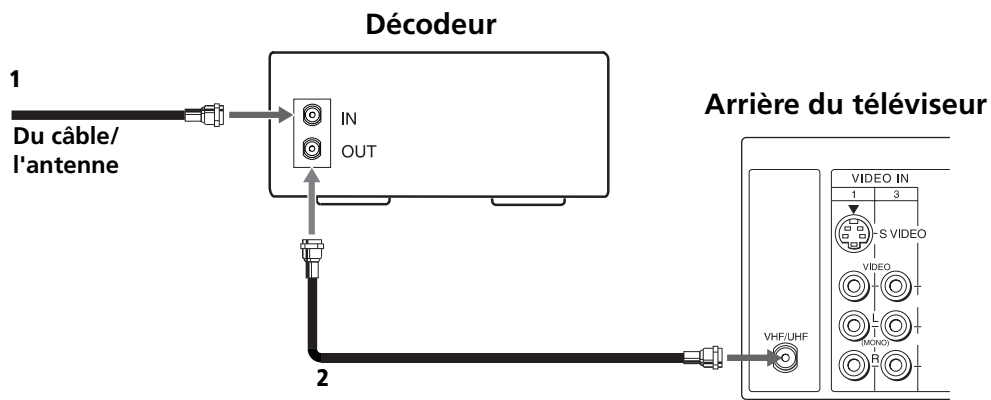

- 1** Raccordez le câble coaxial service du câble sur la prise IN du décodeur.
- 2** Raccordez un câble coaxial (non fourni) entre la prise OUT du décodeur et la prise VHF/UHF du téléviseur.

 Si vous effectuez la sélection de tous les canaux via le décodeur, vous devez envisager d'utiliser la fonction Canal fixe en réglant le téléviseur sur le canal 3 ou 4 (voir page 25).

### Raccordement d'un téléviseur, d'un magnétoscope et d'un décodeur

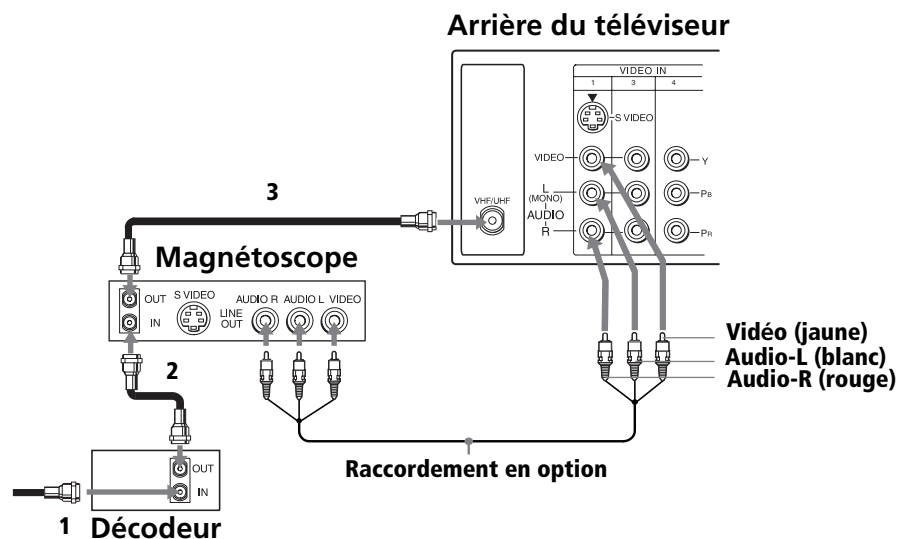



- 1** Raccordez le câble coaxial de votre service du câble sur la prise IN du décodeur.
- 2** Avec un câble coaxial (non fourni), raccordez la prise OUT du décodeur à la prise IN du magnétoscope.
- 3** Raccordez un câble coaxial (non fourni) entre la prise OUT du magnétoscope et la prise VHF/UHF du téléviseur.

 Si vous effectuez la sélection de tous les canaux via le décodeur, vous devez envisager d'utiliser la fonction Canal fixe en réglant le téléviseur sur le canal 3 ou 4 (voir page 25).

#### Raccordement en option

Si votre magnétoscope est équipé de sorties vidéo, vous obtiendrez des images de meilleure qualité en raccordant des câbles audio/vidéo (non fournis) entre les prises AUDIO/VIDEO OUT du magnétoscope et les prises AUDIO/VIDEO IN du téléviseur.

 Pour obtenir des images de meilleure qualité, utilisez la prise S VIDEO au lieu du câble vidéo jaune. La prise S VIDEO ne fournit aucun son. Les câbles audio doivent rester raccordés.

 Vous pouvez utiliser la touche  pour basculer entre les entrées VHF/UHF et VIDEO.

## Raccordement du téléviseur et à un récepteur satellite

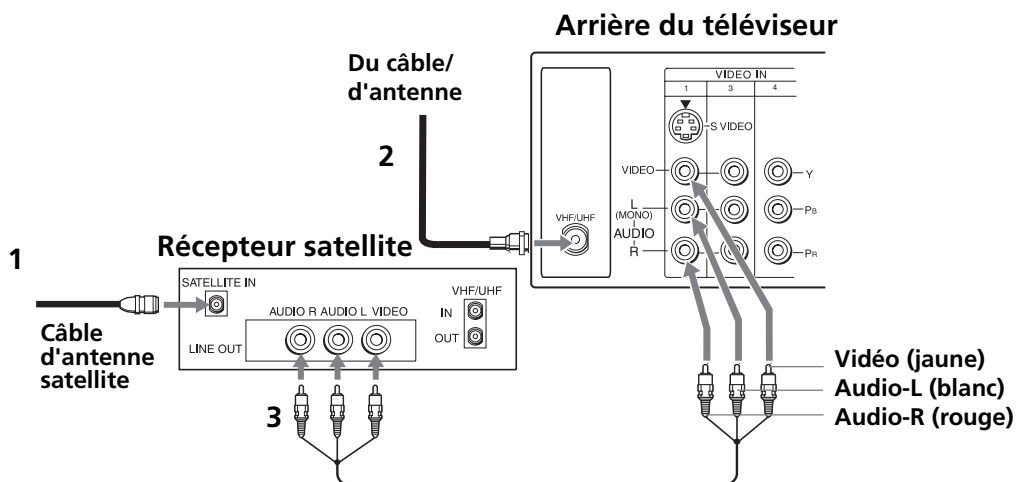

- 1 Raccordez le câble entre l'antenne satellite et la prise SATELLITE IN du récepteur satellite.
- 2 Raccordez le câble coaxial de votre service du câble ou de l'antenne sur la prise VHF/UHF du téléviseur.
- 3 Raccordez les prises AUDIO/VIDEO OUT du récepteur satellite sur les prises AUDIO/VIDEO IN du téléviseur à l'aide de câbles audio/vidéo (non fournis).



Vous pouvez utiliser la touche **TV/VIDEO** pour basculer entre les entrées VHF/UHF et VIDEO.

Pour obtenir des images de meilleure qualité, utilisez la prise S VIDEO au lieu du câble vidéo jaune. La prise S VIDEO ne fournit aucun son. Les câbles audio doivent rester raccordés.

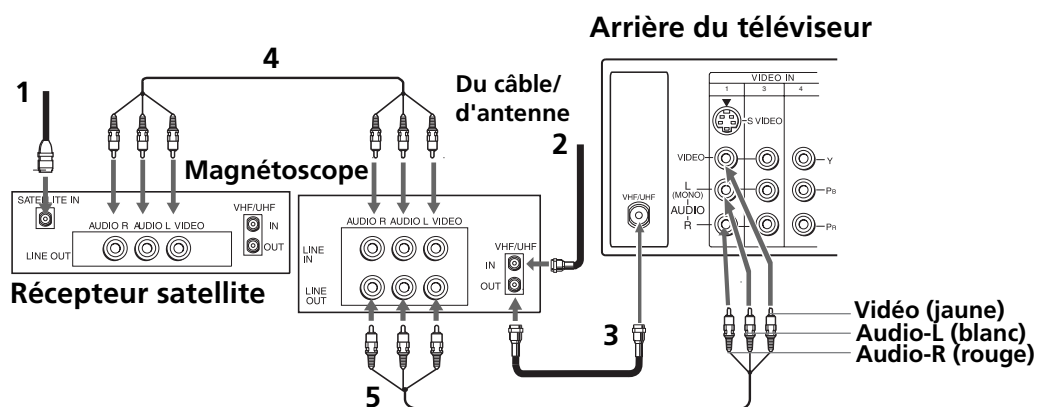
## Raccordement du téléviseur à un récepteur satellite et à un magnétoscope



- 1** Raccordez le câble de votre antenne satellite à SATELLITE IN sur votre récepteur satellite.
- 2** Raccordez les connecteurs coaxial de votre câble ou antenne à VHF/UHF sur votre magnétoscope.
- 3** À l'aide d'un câble coaxial (non fourni), raccordez VHF/UHF OUT sur votre magnétoscope à VHF/UHF sur votre téléviseur.
- 4** À l'aide de câble audio/vidéo (non fourni), raccordez AUDIO/VIDEO OUT de votre récepteur satellite à AUDIO/VIDEO IN sur votre magnétoscope.
- 5** À l'aide de câble audio/vidéo (non fourni), raccordez AUDIO/VIDEO OUT de votre magnétoscope à AUDIO/VIDEO IN sur votre téléviseur.

 Pour obtenir des images depuis le récepteur satellite ou le magnétoscope, sélectionnez l'entrée vidéo sur laquelle le récepteur satellite ou le magnétoscope est raccordé en appuyant sur la touche  de la télécommande.

### Raccordement d'un lecteur DVD

Raccordez les prises AUDIO/VIDEO OUT du lecteur DVD sur les prises AUDIO/VIDEO IN du téléviseur à l'aide de câbles audio/vidéo (non fournis).

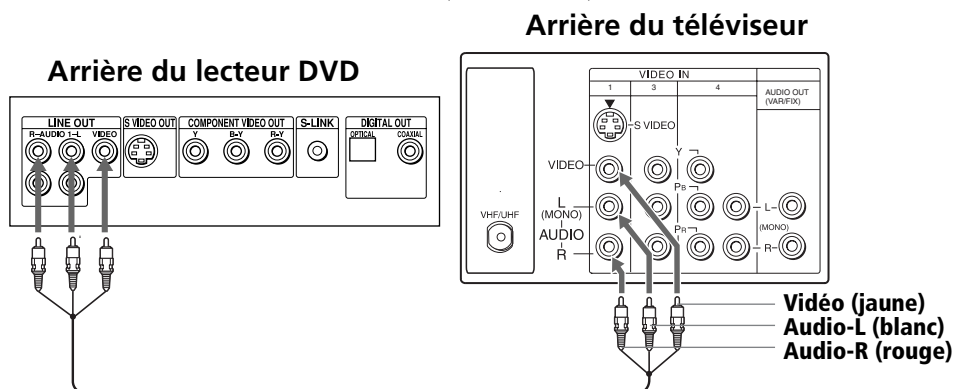

Utilisez la prise S VIDEO au lieu du câble vidéo jaune pour obtenir des images de meilleure qualité. La prise S VIDEO ne fournit aucun son. Les câbles audio doivent rester raccordés.

### Raccordement en option

Si votre lecteur DVD est équipé de sorties composante vidéo (Y, P<sub>B</sub>, P<sub>R</sub>), vous pouvez optimiser la qualité de l'image à l'aide des câbles composante vidéo (480i seulement).

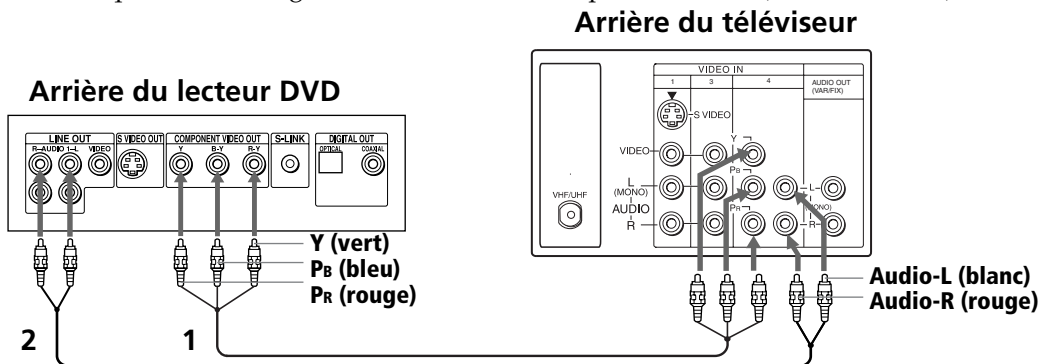

- 1 Raccordez les prises Y, P<sub>B</sub>, P<sub>R</sub> OUT du lecteur DVD sur les prises Y, P<sub>B</sub>, P<sub>R</sub> IN du téléviseur à l'aide de câbles composante vidéo (non fournis).
- 2 Raccordez la prise AUDIO OUT du lecteur DVD sur la prise AUDIO IN du téléviseur.

Les sorties Y, P<sub>B</sub>, P<sub>R</sub> du lecteur DVD sont parfois désignées par Y, CB et CR ou Y, B-Y et R-Y. Dans ce cas, raccordez les câbles selon les couleurs.

### Raccordement d'un caméscope

Raccordez les prises AUDIO/VIDEO OUT du caméscope sur les prises AUDIO/VIDEO INPUT du téléviseur à l'aide de câbles audio/vidéo (non fournis).

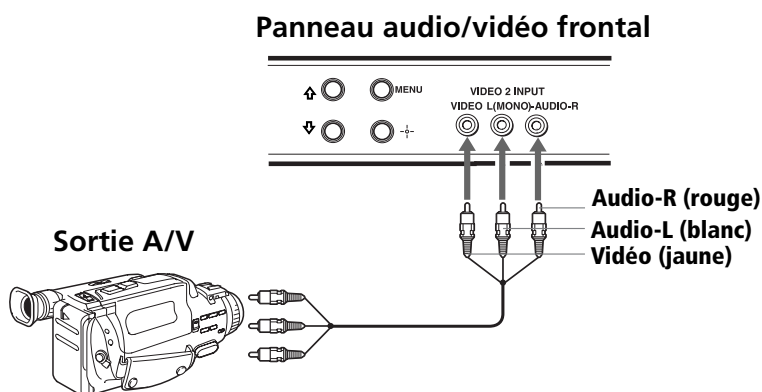

### Raccordement d'une chaîne audio

Avec des câbles audio-vidéo (non fournis), raccordez les prises AUDIO OUT du téléviseur à l'une des entrées de ligne non utilisées de votre chaîne stéréo (p. ex. TV, AUX ou TAPE2).

#### Arrière du téléviseur

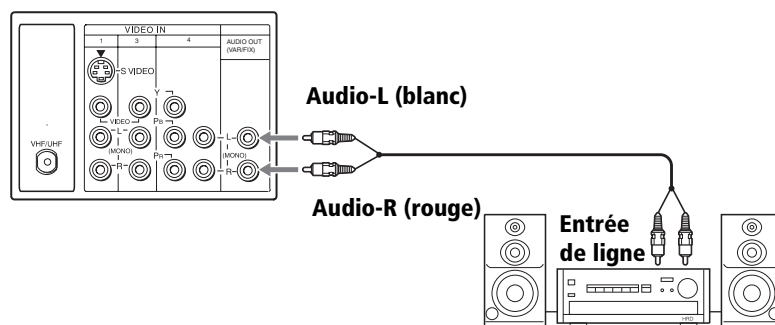

📖 Réglez votre chaîne stéréo à l'entrée de ligne sélectionnée. Pour des directives supplémentaires sur la configuration audio, voir "Utilisation du menu Audio" à la page 23.





# Utilisation des fonctions de base

## Réglage automatique du téléviseur

Après avoir procédé au raccordement de votre téléviseur, vous pouvez utiliser la fonction Auto programmation pour régler les chaînes. Avec la fonction Auto programmation, le téléviseur recherche automatiquement les canaux pouvant être captés et les programme dans la mémoire de l'appareil.











- 1 Appuyez sur  pour mettre le téléviseur sous tension. L'écran de réglage apparaît.





- 2 Appuyez sur la touche  de la télécommande ou sur le panneau avant du téléviseur pour exécuter Auto programmation ou appuyez sur  pour quitter.

 L'écran de réglage apparaît chaque fois que vous mettez le téléviseur sous tension, jusqu'à ce que la fonction Auto programmation ait été exécutée.

### Pour exécuter de nouveau la fonction Auto programmation

- 1 Appuyez sur .
- 2 Appuyez sur  pour mettre le menu Réglage des canaux en surbrillance.
- 3 Appuyez sur  pour mettre Câble en surbrillance. Appuyez sur  pour valider la sélection.
- 4 Appuyez sur  ou  pour sélectionner Oui ou Non selon les raccordements de votre téléviseur. Appuyez sur .
- 5 Appuyez sur  pour mettre Auto programmation en surbrillance. Appuyez sur  pour rechercher les canaux.
- 6 Lorsque la fonction Auto programmation a été exécutée, appuyez sur  pour quitter.

### Pour réinitialiser le téléviseur aux réglages par défaut

- 1 Allumez le téléviseur.
- 2 Maintenez enfoncée la touche  de la télécommande.
- 3 Appuyez sur la touche POWER sur le panneau avant du téléviseur et relâchez-la. (Le téléviseur s'éteint, puis se rallume de lui-même).
- 4 Relâchez la touche .



# Accès rapide aux menus

Les réglages suivants sont disponibles dans les menus d'écran. Pour plus de détails sur le mode d'emploi des menus, voir "Utilisation des menus" à la page 21.

Menu	Permet de
	Procéder aux réglages de l'image.
	Modifier les réglages du son.
	Personnaliser les réglages des chaînes.
	Définir des limites de classements sur votre téléviseur en fonction du contenu ou du classement de l'émission.

Menu

Permet de



Régler l'horloge du téléviseur et programmer avec Minuterie 1 et Minuterie 2.



Sélectionner une option de sous-titrage, saisir une étiquette vidéo, corriger la rotation de l'image, augmenter la résolution de l'image provenant d'un DVD (16:9 amélioré), sélectionner la langue des menus ou lancer une démonstration des menus.

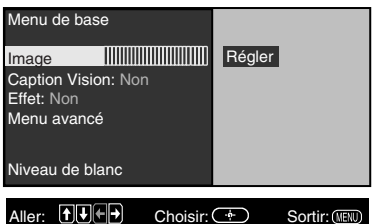







Choisir l'affichage d'un menu simplifié contenant les réglages les plus courants.





# Utilisation des menus

Cette section traite des options disponibles pour configurer et régler votre téléviseur.

## Comment accéder aux menus

- 1** Appuyez sur  pour afficher le menu d'écran.
- 2** Utilisez les touches  ou  pour sélectionner l'élément souhaité dans le menu. Appuyez ensuite sur  pour le valider.
- 3** Utilisez les touches  ou  pour faire défiler les fonctions vers le haut ou vers le bas.
- 4** Suivez les directives à l'écran.
- 5** Consultez la page de menu spécifique pour obtenir des directives de navigation dans ce menu.
- 6** Appuyez sur  pour quitter le menu.

 Appuyez sur  une fois pour afficher le menu à l'écran. Appuyez de nouveau pour revenir à l'écoute normale. Si aucune touche n'est enfoncée, le menu se referme automatiquement après environ 90 secondes.

## Utilisation du menu Vidéo



Pour ouvrir le menu Vidéo, suivez les étapes ci-dessous:

**Pour afficher**



**Pour sélectionner**



Appuyez sur  pour sélectionner une option, puis appuyez sur .

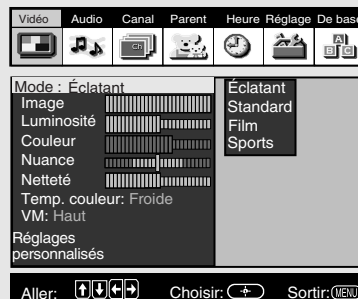

### Mode

*Visualisation personnalisée d'images*

Utilisez la touche  ou  pour sélectionner l'une des options suivantes.



Appuyez ensuite sur  pour valider votre sélection.

**Éclatant :** Sélectionnez cette fonction pour obtenir un contraste et une netteté de l'image plus marqués.



**Standard :** Sélectionnez cette fonction pour obtenir une image standard.



**Film :** Sélectionnez cette fonction pour obtenir une image précise.



**Sports :** Sélectionnez cette fonction pour obtenir une image lumineuse.



 Pour accéder directement aux modes image personnalisés (Éclatant, Standard, Film, Sports), appuyez sur la touche  de la télécommande.



### Commandes de réglage de l'image

**Image :** Appuyez sur  pour diminuer le contraste. Appuyez sur  pour augmenter le contraste.

**Luminosité :** Appuyez sur  pour assombrir l'image. Appuyez sur  pour éclaircir l'image.

**Couleur :** Appuyez sur  pour diminuer la saturation des couleurs. Appuyez sur  pour augmenter la saturation des couleurs.

**Nuance :** Appuyez sur  pour augmenter les tons rouges. Appuyez sur  pour augmenter les tons verts.

**Netteté :** Appuyez sur  pour adoucir l'image. Appuyez sur  pour rendre l'image plus nette.

### Temp. couleur

*Réglage de la teinte des blancs*

Utilisez la touche  ou  pour sélectionner l'une des options suivantes. Appuyez ensuite sur  pour valider la sélection.

**Froide :** Donne une teinte bleue aux couleurs blanches.



**Neutre :** Donne une teinte neutre aux couleurs blanches.

**Chaude :** Donne une teinte rouge aux couleurs blanches.

### VM

*Modulation de la vitesse*

Accroît la définition de l'image et lui donne des contours nets et précis.

Utilisez la touche  ou  pour sélectionner l'une des options suivantes: **Haut, Bas, Non.** Appuyez ensuite sur .

## Utilisation du menu Audio

Pour ouvrir le menu Audio, suivez les étapes ci-dessous :

**Pour afficher**



**Pour mettre surbrillance**







**Pour sélectionner**





Appuyez sur  pour sélectionner une option, puis appuyez sur .



**Aigu** Appuyez sur  pour diminuer les sons les plus élevés. Appuyez sur  pour augmenter les sons les plus élevés.



**Grave** Appuyez sur  pour diminuer les sons les plus graves. Appuyez sur  pour augmenter les sons les plus graves.



**Balance** Appuyez sur  pour accentuer le son du haut-parleur gauche. Appuyez sur  pour accentuer le son du haut-parleur droit.

**Effet** Utilisez la touche  ou  pour sélectionner l'une des options suivantes. Appuyez ensuite sur  pour valider la sélection.

**Ambiophonie** : Simule un son d'une qualité tridimensionnelle pour les programmes en stéréo.

**Non** : Réception stéréo ou mono normale.

 Appuyez sur  pour sélectionner directement l'option de réglage Effet (Ambiophonie, Non).



**MTS** Utilisez la touche  ou  pour sélectionner l'une des options suivantes. Appuyez ensuite sur  pour valider la sélection.

*Son multi-canal*

**Stéréo** : Sélectionnez cette option lorsque vous regardez une émissions en stéréo.

**Auto SAP** : Sélectionnez cette option pour que le téléviseur passe automatiquement à un programme audio secondaire (SAP) lorsqu'un signal est reçu.

**Mono** : Sélectionnez cette option pour réduire les parasites dans les zones où la réception est médiocre.

 Pour accéder directement aux réglages MTS (Stéréo, Auto SAP, Mono), appuyez sur la touche  de la télécommande.

 Si votre téléviseur est réglé sur SAP auto, il est possible que le son de certains programmes soit mis en sourdine ou déformé. Si votre téléviseur n'émet aucun son, réglez Audio MTS sur Stéréo ou Mono.

## Mode d'emploi

---

**Haut-parleur** Utilisez la touche  $\uparrow$  ou  $\downarrow$  pour sélectionner l'une des options suivantes.  
*Sélection personnalisée de la source de sortie audio* Appuyez ensuite sur  $\rightarrow$  pour valider la sélection.

**Oui :** Sélectionnez cette option pour écouter le son à partir des haut-parleurs du téléviseur avec ou sans une chaîne stéréo indépendante.

**Non :** Sélectionnez cette option pour désactiver les haut-parleurs du téléviseur et écouter le son du téléviseur uniquement via les enceintes d'une chaîne audio externe.

**Sortie audio** Utilisez la touche  $\uparrow$  ou  $\downarrow$  pour sélectionner l'une des options suivantes.  
*Utilisez cette fonction pour commander le volume du téléviseur via une chaîne stéréo* Appuyez ensuite sur  $\rightarrow$  pour valider la sélection.

**Variable :** Règle le volume par l'intermédiaire du téléviseur.

**Fixe :** Règle le volume du téléviseur par l'intermédiaire d'une chaîne stéréo raccordée.

 Sortie audio peut être réglée uniquement lorsque Haut-parleur est réglé sur Non.

## Utilisation du menu Réglage des canaux



Pour accéder au menu Réglage des canaux, procédez comme suit :

**Pour afficher** **Pour mettre en surbrillance** **Pour sélectionner**



Appuyez sur pour sélectionner une option, puis appuyez sur .



### Canaux préférés

*Accès rapide aux canaux préférés*

- 1 Appuyez sur pour effectuer votre sélection.
- 2 Sélectionnez la position (1 à 8) où vous souhaitez régler une chaîne préférée à l'aide des touches ou , puis appuyez sur .
- 3 Sélectionnez le canal souhaité à l'aide de la touche ou . Appuyez sur pour passer sur le canal sélectionné.
- 4 Appuyez sur pour revenir au menu Réglage des canaux ou appuyez sur pour quitter.

Pour utiliser la fonction Canaux préférés : quittez tous les menus et appuyez sur . Appuyez sur ou pour déplacer le curseur vers le numéro de canal souhaité et appuyez sur .

### Câble

Utilisez la touche ou pour sélectionner l'une des options suivantes. Appuyez ensuite sur pour valider la sélection.

- Oui :** Sélectionnez cette option si vous recevez des chaînes câblées avec un câble CATV.
- Non :** Sélectionnez cette option si vous utilisez une antenne de télévision.

Vous devez exécuter la fonction Auto programmation après avoir modifié vos réglages de câble.

### Canal fixe

Utilisez la touche ou pour sélectionner l'une des options suivantes. Appuyez ensuite sur pour valider la sélection.

- Non :** Canal fixe n'est pas réglé.
- 2-6 :** Sélectionnez cette option pour contrôler toutes les sélections de canaux via un décodeur ou un magnétoscope. Sélectionnez le canal approprié (en général 3 ou 4) et utilisez la télécommande du décodeur ou du magnétoscope pour sélectionner les canaux.
- Vidéo 1 :** Sélectionnez l'une des entrées vidéo disponibles lorsque vous avez raccordé l'appareil vidéo (par exemple un récepteur satellite) et que vous souhaitez régler le téléviseur en fonction de cet appareil.



## Mode d'emploi

**Auto programmation** Utilisez la fonction Auto programmation à chaque fois que vous réglez votre téléviseur.  
Avec la fonction Auto programmation, le téléviseur recherche automatiquement les canaux pouvant être captés et les programme dans la mémoire de l'appareil.

**Saut/Ajout canal** Utilisez cette fonction après avoir exécuté Auto programmation pour omettre des chaînes que vous ne souhaitez pas ou en ajouter des nouvelles.

- 1 Sélectionnez la position de la chaîne souhaitée à l'aide des touches  $\uparrow$  ou  $\downarrow$ , puis appuyez sur  $\oplus$ .
- 2 Sélectionnez Saut ou Ajout à l'aide des touches  $\uparrow$  ou  $\downarrow$ , puis appuyez sur  $\oplus$ .
- 3 Appuyez sur  $\leftarrow$  pour revenir au menu Réglage des canaux ou appuyez sur  $\text{MENU}$  pour quitter.

 Lorsque vous appuyez sur CH (canal) + ou CH (canal) -, les canaux sautés sont ignorés et le canal suivant est sélectionné. Vous pouvez quand même accéder aux canaux ignorés en vous servant des touches  $\text{0-9}$ .

**Légende de canal**

*Permet de nommer 40 chaînes au maximum avec des indicatifs littéraux.*

- 1 Appuyez sur  $\text{CH}$ , puis sur  $\uparrow$  ou  $\downarrow$  jusqu'à ce que le numéro du canal souhaité soit atteint.
- 2 Appuyez sur  $\text{CH}$  pour activer le canal.
- 3 Appuyez sur  $\text{CH}$ , puis utilisez la touche  $\uparrow$  ou  $\downarrow$  pour afficher le premier nombre ou la première lettre de l'indicatif du titre, puis appuyez sur  $\oplus$  pour le sélectionner. Lorsque la saisie est terminée, appuyez sur  $\oplus$  pour l'activer.

 Lorsque la fonction Canal fixe est activée, les fonctions suivantes ne sont pas disponibles : Canaux préférés, Câble, Saut/Ajout canal, Légende de canal.

## Utilisation du menu Parent



Pour ouvrir le menu Parent, suivez les étapes ci-dessous :

**Pour afficher**

**Pour mettre en surbrillance**

**Pour sélectionner**

The screenshot shows a menu with options: Vidéo, Audio, Canal, Parent, Heure, Réglage, De base. The 'Parent' option is highlighted. Below the menu, a password prompt reads: 'Mot de passe: [ ] [ ] [ ] [ ]' and 'Avec les touches 0-9 entrer un nouveau mot de passe'. At the bottom, navigation controls are shown: Aller: (Up, Down, Left, Right), Choisir: (+), Sortir: (MENU).

La fonction de Contrôle parental est conçue pour aider les parents à surveiller ce que leurs enfants regardent à la télévision.

### Utilisation du menu Parent

Dans le menu Parent, un message vous invite à choisir un mot de passe à quatre chiffres qui est ensuite nécessaire pour accéder au menu Parent.

- 1** Avec les touches ①-⑨, saisissez un nouveau mot de passe à quatre chiffres.
- 2** Confirmez votre mot de passe en le saisissant de nouveau.

Conservez ce mode d'emploi en lieu sûr. Une fois enregistré, le mot de passe est nécessaire pour accéder au menu de contrôle parental. En cas d'oubli du mot de passe, voir page 42.

Lorsque le mot de passe est réglé correctement, le menu Parent suivant apparaît.

## Contrôle parental

### Réglage du classement

Vous pouvez modifier le classement en sélectionnant l'une des options de blocage.



1 Lorsque Blocage parental est mis en surbrillance, appuyez sur **[+]**.

Si le système de classification à l'intention des parents ne vous est pas familier, utilisez une des catégories prédéfinies suivantes pour simplifier la sélection : Enfant, Jeune, Adolescent

2 Sélectionnez le classement souhaité à l'aide des touches **[↑]** ou **[↓]**, puis appuyez sur **[+]**.

Classement	Le téléviseur bloque les émissions dont la classification dépasse :
Enfant	TV-Y, TV-G, G (modèles américains seulement), G, C (modèles canadiens seulement)
Jeune	TV-PG, PG (modèles américains seulement), 8 ans + (modèles canadiens seulement)
Adolescent	TV-14, PG-13 (modèles américains seulement), 14+ (modèles canadiens seulement)
Spécifique	Sélectionnez cette option pour définir des classements plus restrictifs (voir la section suivante)
Non	Aucune limite de classement

### Modification du mot de passe

1 Déplacez le curseur à l'aide des touches **[↑]** ou **[↓]** pour activer Changer le Mot de passe, puis appuyez sur **[+]**.

2 Suivez les étapes 1 et 2 de la section " Utilisation du menu Parent ", page 27.

### Sélection d'un pays



Sélectionnez U.S.A. pour la classification américaine (voir les pages 30-31) ou Canada pour la classification canadienne (voir page 32). Si vous sélectionnez un pays (Etats-Unis ou Canada) qui n'est pas celui où vous utilisez le téléviseur, le blocage sélectionné n'est pas activé.

1 Appuyez sur **[↓]** pour sélectionner Pays, puis appuyez sur **[+]**.

2 Utilisez la touche **[↑]** ou **[↓]** pour sélectionner le pays (États-unis ou Canada), puis appuyez sur **[+]**.

### Information des parents

#### Pour regarder une émission qui sort du classement

- Appuyez sur , puis utilisez les touches - pour saisir votre mot de passe.

 Si vous entrez votre mot de passe pour regarder un programme bloqué, l'option Blocage sera temporairement réglée sur Non. Pour réactiver les réglages Blocage, éteignez votre téléviseur et remettez le sous tension. Le téléviseur revient aux réglages que vous avez sélectionnés.

### Utilisation du menu Spécifique

Suivez les instructions affichées à l'écran pour effectuer vos réglages personnalisés. Sélectionnez le pays souhaité pour vos limites de classement des émissions de télévision. Consultez la page 30 pour les modèles américains la page 32 pour les modèles destinés au canadiens afin d'obtenir plus d'informations.

 Lorsque vous avez bloqué un classement ou un contenu, tous les classements ou contenus supérieurs seront automatiquement bloqués.

## États-unis : sélection des options de classement spécifique

Pour les modèles destinés aux États-unis, le menu Classement spécifique comprend les options suivantes : Classement des films, Classement de télé et Non-classée (Pour les modèles destinés au Canada, voir page 32).

### Classement des films

Ce système définit les niveaux de classement des films projetés dans les cinémas et sur les principales chaînes du câble.

Classement	Description
<b>G</b>	Tout public
<b>PG</b>	Surveillance parentale recommandée
<b>PG-13</b>	Les parents sont sérieusement mis en garde
<b>R</b>	Accès limité
<b>NC-17</b>	Interdit aux spectateurs de 17 ans ou moins
<b>X</b>	Réservé aux adultes

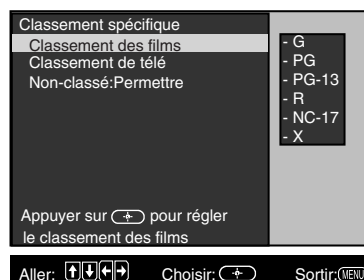

### Classement de télé

Le classement de télé est divisé en deux groupes : en fonction de l'âge et en fonction du contenu.



Âge	Description	Contenu	Description
<b>TV-Y</b>	Tous les enfants	<b>FV</b>	Violence d'imagination
<b>TV-Y7</b>	Pour les enfants plus âgés	<b>D</b>	Dialogues suggestifs
<b>TV-G</b>	Tout public	<b>L</b>	Langage grossier
<b>TV-PG</b>	Surveillance parentale recommandée	<b>S</b>	Scènes sexuelles
<b>TV-14</b>	Avertissement adressés aux parents	<b>V</b>	Violence
<b>TV-MA</b>	Réservé aux adultes exclusivement		

 Les classements du contenu augmentent selon le niveau du classement basé sur l'âge. Par exemple, une émission classée TV-PG V (violence) peut contenir des scènes de violence modérée tandis qu'un classement TV-14 V (violence) peut contenir des scènes très violentes.

### Non classée

Vous pouvez bloquer des émissions de télévision ou des films qui ne sont pas classés.

<b>Permettre</b>	Autorise toutes les émissions non classées
<b>Bloquer</b>	Bloque toutes les émissions non classées

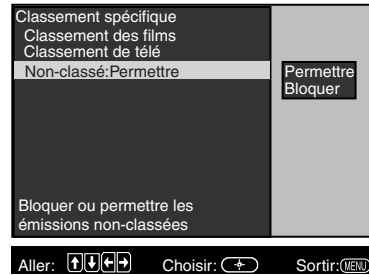

 Si vous choisissez de bloquer les émissions de télévision non classées, notez que les émissions suivantes seront également bloquées : bulletins d'informations d'urgence, émissions politiques, sports, actualités, annonce des services publics, émissions religieuses et la météo.

## Canada : sélection des options de classement spécifique

Pour les modèles destinés au Canada, le menu Classement spécifique comprend les options suivantes : Classement anglais, Classement français et Classement U.S.A.

### Classement anglais

Ces classements concernent les émissions canadiennes diffusées en anglais.

Classement	Description
<b>C</b>	Enfants
<b>C8+</b>	Enfants de 8 ans et plus
<b>G</b>	Tout public
<b>PG</b>	Supervision parentale
<b>14+</b>	Spectateurs de 14 ans et plus
<b>18+</b>	Émission réservée aux adultes



### Classement français

Ces classements concernent les émissions canadiennes diffusées en français.

Classement	Description
<b>G</b>	Tout public
<b>8 ans+</b>	Déconseillé aux jeunes enfants
<b>13 ans+</b>	Déconseillé aux enfants de moins de 13 ans
<b>16 ans+</b>	Déconseillé aux enfants de moins de 16 ans
<b>18 ans+</b>	Cette émission est destinée aux adultes exclusivement

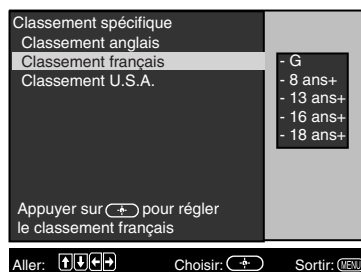

### Classement U.S.A.

Pour les émissions provenant des États-unis, veuillez vous reporter à " Classement des émissions " page 30.

## Utilisation du menu Heure

Pour ouvrir le menu Heure, suivez les étapes ci-dessous :

**Pour afficher**



**Pour mettre en surbrillance**









**Pour sélectionner**





### Heure

Réglez votre téléviseur au jour et à l'heure actuelles. Appuyez sur  pour ouvrir le menu Heure :







- 1 Utilisez la touche  ou  pour saisir le jour et l'heure correcte, puis appuyez sur .
- 2 Appuyez sur  pour revenir au menu Heure ou sur  pour quitter le menu.

 Vous devez régler l'heure actuelle avant d'utiliser les fonctions Minuterie 1 et Minuterie 2.

### Minuterie 1 et Minuterie 2

*Visualisation programmée*

Les minuteries permettent de programmer la mise sous tension et hors tension du téléviseur selon le jour, l'heure et la durée, ainsi que le canal à syntoniser. La durée maximale du programme de minuterie est de six heures. Lorsque la fonction Canal fixe est active, il n'est pas nécessaire de programmer le canal.

- 1 Sélectionnez Minuterie 1 ou Minuterie 2 à l'aide des touches  ou , puis appuyez sur .
- 2 Appuyez sur  ou  pour saisir le jour, l'heure, la durée et le canal, puis appuyez sur . Une fois son réglage terminé, la minuterie doit être réglée sur Oui, et le témoin de minuterie devrait s'allumer sur le panneau avant du téléviseur.
- 3 Appuyez sur  pour quitter le menu.

 Sélectionnez Non pour désactiver la minuterie (les réglages précédents sont sauvegardés).

 Lorsque vous exécutez Auto programmation, les réglages Minuterie 1 et Minuterie 2 sont effacés. De même, en cas de coupure d'alimentation, les réglages Heure, Minuterie 1 et Minuterie 2 sont effacés.



## Utilisation du menu Réglage

Pour accéder au menu Réglage, procédez comme suit :

Pour afficher



Pour mettre en surbrillance



Pour sélectionner



Appuyez sur  pour sélectionner une option, puis appuyez sur .



### Caption

#### Vision

*Sous-titrage*

Permet de sélectionner l'un des trois modes de sous-titrage (pour les émissions diffusées avec l'option sous-titres).

Utilisez la touche  ou  pour sélectionner l'une des options suivantes.

Appuyez ensuite sur  pour valider la sélection.

**Non :** Les sous-titres ne sont pas activés.

**CC1, 2, 3, 4 :** Affiche le dialogue imprimé et les effets sonores d'une émission.

**Text1, 2, 3, 4 :** Affiche des informations du réseau/de la station.



**Info :** Affiche le nom du programme en cours et son temps restant, si ces informations sont disponibles.



### Étiquette

#### vidéo

*Donne un nom aux appareils raccordés*



Permet d'attribuer des noms aux appareils audio et vidéo raccordés au téléviseur : magnétoscope, lecteur de DVD, etc. Lorsque vous commutez la source du signal en appuyant sur TV/VIDEO, l'étiquette vidéo s'affiche à l'écran.

**1** Appuyez sur les touches  ou  pour accéder à l'entrée que vous souhaitez nommer, puis appuyez sur .

**2** Choisissez un nom à l'aide des touches  ou , puis appuyez sur .



 Si vous sélectionnez "Saut", le téléviseur saute cette prise lorsque vous appuyez sur la touche TV/VIDEO.

### Rotation

Appuyez sur  ou  pour corriger une inclinaison de l'image de - 5 à + 5, puis appuyez sur .

### Langue

Affiche tous les menus dans la langue de votre choix.

Utilisez la touche  ou  pour sélectionner l'une des options suivantes: English (anglais), Español (espagnol), Français. Appuyez ensuite sur la touche .

### 16:9 amélioré

Améliore la résolution des images provenant de sources au format grand écran, par exemple les films sur DVD (disponible uniquement lorsque le téléviseur est en mode VIDEO).

### Démo

Appuyez sur  pour lancer une démonstration des menus à l'écran.

 Appuyez sur n'importe quelle touche pour quitter le mode Démo.

## Utilisation du Menu de base

Pour accéder au base Réglage, procédez comme suit :

**Pour afficher**











**Pour mettre en surbrillance**







**Pour sélectionner**



Appuyez sur  pour sélectionner une option, puis appuyez sur .

<b>Image</b> <i>Contraste de l'image</i>	Appuyez sur  pour diminuer le contraste. Appuyez sur  pour augmenter le contraste.
<b>Caption Vision</b> <i>Sous-titres</i>	Dans le Menu de base, les options de sous-titrage comprennent Non et la dernière option de sous-titrage sélectionnée (CC1-4, Text1-4 ou Info).
<b>Effet</b>	Utilisez la touche  ou  pour sélectionner l'une des options suivantes. Appuyez ensuite sur  pour valider la sélection. <b>Ambiophonie :</b> Simule un son d'une qualité tridimensionnelle pour les programmes en stéréo. <b>Non :</b> Réception stéréo ou mono normal.
<b>Menu avancé</b>	Appuyez sur  pour revenir au menu avancé.







 Si vous quittez le Menu de base en appuyant sur  , seul le Menu de base s'affiche lorsque vous appuyez de nouveau sur  . Pour accéder aux autres menus, utilisez  pour faire défiler le menu vers le bas et sélectionnez Menu avancé, puis appuyez sur .



# Informations complémentaires

## Programmation de la télécommande

Vous pouvez utiliser la télécommande fournie pour piloter des appareils vidéo Sony ou autres.

- 1 Appuyez sur .
- 2 Appuyez sur  ou  (FUNCTION).
- 3 Utilisez les touches - pour saisir le numéro de code à partir du tableau suivant.
- 4 Appuyez sur .

### Codes des magnétoscopes

Sony	301, 302, 303	JCPenney	309, 305, 304, 330, 314, 336, 337
Admiral (M.Ward)	327	JVC	314, 336, 337, 345, 346, 347
Aiwa	338, 344	Kenwood	314, 336, 332, 337
Audio Dynamic	314, 337	LXI (Sears)	332, 305, 330, 335, 338
Broksonic	319, 317	Magnavox	308, 309, 310
Canon	309, 308	Marantz	314, 336, 337
Citizen	332	Marta	332
Craig	302, 332	Memorex	309, 335
Criterion	315	Minolta	305, 304
Curtis Mathis	304, 338, 309	Mitsubishi/MGA	323, 324, 325, 326
Daewoo	341, 312, 309	Multitech	325, 338, 321
DBX	314, 336, 337	NEC	314, 336, 337
Dimensia	304	Olympic	309, 308
Emerson	319, 320, 316, 317, 318, 341	Optimus	327
Fisher	330, 335	Panasonic	308, 309, 306, 307
Funai	338	Pentax	305, 304
General Electric	329, 304, 309	Philco	308, 309
Go Video	322, 339, 340	Philips	308, 309, 310
Goldstar	332	Pioneer	308
Hitachi	306, 304, 305, 338	Quasar	308, 309, 306
Instant Replay	309, 308	RCA/PROSCAN	304, 305, 308, 309, 311, 312, 313, 310, 329
Realistic	309, 330, 328, 335, 324, 338	Symphonic	338
Samsung	322, 313, 321	Tashiro	332
Sansui	314	Tatung	314, 336, 337
Sanyo	330, 335	Teac	314, 336, 338, 337

## Informations complémentaires

### Codes des magnétoscopes

Scott	312, 313, 321, 335, 323, 324, 325, 326	Technics	309, 308
Sharp	327, 328	Toshiba	312, 311
Shintom	315	Wards	327, 328, 335, 331, 332
Signature 2000 (M. Ward)	338, 327	Yamaha	314, 330, 336, 337
SV2000	338	Zenith	331
Sylvania	308, 309, 338, 310		

### Codes des décodeurs

Sony	230
Hamlin/Regal	222, 223, 224, 225, 226
Jerrold/G. I.	201, 202, 203, 204, 205, 206, 207, 208, 218
Oak	227, 228, 229
Panasonic	219, 220, 221
Pioneer	214, 215
Scientific Atlanta	209, 210, 211
Tocom	216, 217
Zenith	212, 213

### Codes des lecteurs de disque laser

Sony	701
Panasonic	704, 710
Pioneer	702

### Codes DBS

DIRECTV	809
Echostar/Dish Network	810

### Codes des récepteurs satellite

Sony	801
General Electric	802
Hitachi	805
Hughes	804
Panasonic	803
RCA/PROSCAN	802, 808
Toshiba	806, 807

### Codes des lecteurs de DVD









Sony	751
JVC	756
Mitsubishi	761
Onkyo	762
Oritron	759
Panasonic	753
Philips/Magnavox	757
Pioneer	752
RCA	755
Samsung/Hitachi	758
Toshiba	754
Zenith	760

 S'il existe plusieurs numéros de code dans la liste, essayez de les saisir un par un jusqu'à ce que vous trouviez le code correspondant à votre appareil.









 A chaque fois que vous retirez les piles, il est possible que les numéros de code reviennent aux réglages par défaut et que vous soyez obligés de les réinitialiser.

 Dans certains cas rares, il se peut que vous ne puissiez pas faire fonctionner vos appareils avec la télécommande fournie. En pareil cas, utilisez la télécommande fournie avec l'appareil.



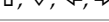

### Fonctionnement d'un magnéscope

Appuyer sur	Pour
	Mettre le magnéscope sous tension
	Sélectionner directement des canaux
	Changer de canaux
	Lire une cassette vidéo
	Arrêter
	Faire une recherche vers l'avant ou l'arrière
	Faire une pause
	Enregistrer
	Basculer entre les entrées du magnéscope et du téléviseur

### Fonctionnement d'un lecteur DVD



Appuyer sur	Pour
	Mettre le DVD sous tension
	Sélectionner des chapitres directement
	Rechercher des chapitres vers l'avant ou l'arrière
	Lire un DVD
	Arrêter
	Faire une pause
	Déplacer le curseur dans le menu
	Afficher le menu DVD



### Fonctionnement d'un lecteur de disque laser

Appuyer sur	Pour
	Mettre le lecteur de disque laser sous tension
	Rechercher des chapitres vers l'avant ou l'arrière
	Lire le disque
	Arrêter
	Faire une pause

# Guide de dépannage

Si vous rencontrez un problème avec votre téléviseur, essayez d'appliquer les suggestions ci-dessous. Si le problème persiste, contactez votre distributeur Sony.

Problème	Solutions possibles
<b>Pour réinitialiser le téléviseur aux réglages par défaut</b>	<ul style="list-style-type: none"><li>❑ Allumez le téléviseur. Tout en maintenant enfoncée la touche RESET de la télécommande, appuyez sur la touche POWER sur le panneau avant du téléviseur. (Le téléviseur s'éteint, puis se rallume de lui-même). Relâchez ensuite la touche RESET.</li></ul>
<b>Aucune image, aucun son</b>	<ul style="list-style-type: none"><li>❑ Vérifiez que le cordon d'alimentation est branché.</li><li>❑ Si un voyant rouge clignote à l'avant de votre téléviseur pendant plusieurs minutes, débranchez, puis rebranchez le cordon d'alimentation pour réinitialiser le téléviseur. Si le problème persiste, contactez votre service après-vente local.</li><li>❑ Vérifiez les réglages TV/VIDEO : réglez sur TV lorsque vous regardez la télévision et réglez sur VIDEO lorsque vous regardez un appareil vidéo (page 5).</li><li>❑ Vérifiez que les piles sont insérées correctement dans la télécommande (page 2).</li><li>❑ Essayez une autre chaîne, il peut s'agir d'un problème de station.</li></ul>
<b>Aucune image ou image médiocre, bon son</b>	<ul style="list-style-type: none"><li>❑ Réglez l'image dans le menu Vidéo (page 22).</li><li>❑ Réglez la luminosité dans le menu Vidéo (page 22).</li><li>❑ Vérifiez les raccordements de l'antenne et/ou du câble (page 8).</li></ul>
<b>Bonne image, aucun son</b>	<ul style="list-style-type: none"><li>❑ Appuyez sur  de sorte que Muting disparaisse de l'écran (page 3).</li><li>❑ Vérifiez vos réglages du son. Le téléviseur est peut-être réglé sur Auto SAP dans la fonction MTS (page 23).</li><li>❑ S'assurer que la fonction Haut-parleur du menu Audio est en position Oui (page 24).</li><li>❑ Appuyez sur  pour augmenter le volume sonore du téléviseur, qui est probablement trop faible.</li></ul>
<b>Aucune couleur</b>	<ul style="list-style-type: none"><li>❑ Réglez la couleur dans le menu Vidéo (page 22).</li></ul>
<b>Seulement de la neige apparaît sur l'écran</b>	<ul style="list-style-type: none"><li>❑ Vérifiez le réglage de Câble dans le menu Réglage des canaux (page 25).</li><li>❑ Vérifiez les raccordements de l'antenne et/ou du câble (page 8).</li><li>❑ Vérifiez que la chaîne sélectionnée est en cours de diffusion.</li></ul>
<b>Lignes en pointillés ou rayures</b>	<ul style="list-style-type: none"><li>❑ Réglez l'antenne.</li><li>❑ Éloignez le téléviseur des autres appareils électroniques. Certains appareils électroniques peuvent créer des parasites électriques susceptibles de perturber la réception du téléviseur.</li></ul>

Problème	Solutions possibles
<b>Images doubles ou fantômes</b>	<ul style="list-style-type: none"> <li>❑ Vérifier l'antenne extérieure ou contactez votre fournisseur de câblodistribution.</li> </ul>
<b>Impossible de recevoir des canaux dont le numéro est élevé (UHF) avec une antenne</b>	<ul style="list-style-type: none"> <li>❑ Vérifiez que l'option Câble est réglée sur Non dans le menu Réglage des canaux (page 25).</li> <li>❑ Exécutez la fonction Auto programmation pour ajouter des chaînes qui ne sont pas enregistrées dans la mémoire (page 17).</li> </ul>
<b>Il semble que certaines stations câblées ne fonctionnent pas.</b>	<ul style="list-style-type: none"> <li>❑ Vérifiez que l'option Câble est réglée sur Oui dans le menu Réglage des canaux (page 25).</li> <li>❑ Exécutez la fonction Auto programmation pour ajouter des chaînes qui ne sont pas enregistrées dans la mémoire (page 17).</li> </ul>
<b>La télécommande ne fonctionne pas</b>	<ul style="list-style-type: none"> <li>❑ Appuyez sur TV (FUNCTION) pour faire fonctionner le téléviseur.</li> <li>❑ Vérifiez le sens d'insertion des piles.</li> <li>❑ Les piles sont peut-être faibles. Remplacez les piles (page 2).</li> <li>❑ Placez le téléviseur à une distance d'au moins 90 à 120 cm (3 à 4 pi) des lampes fluorescentes.</li> </ul>
<b>Impossible de changer de canal à l'aide de la télécommande</b>	<ul style="list-style-type: none"> <li>❑ Si vous changez de canal avec un autre appareil, vérifiez que le réglage du téléviseur au canal 3 ou 4 n'a pas été changé accidentellement .</li> <li>❑ Si vous changez de canal à partir d'un autre appareil, veillez à appuyer d'abord sur la touche FUNCTION correspondant à cet appareil. Par exemple, pour changer de canal à partir du magnétoscope, veillez à appuyer sur la touche VCR/DVD FUNCTION (page 4).</li> </ul>
<b>Impossible d'accéder aux autres menus à partir du Menu de base</b>	<ul style="list-style-type: none"> <li>❑ Si vous quittez le Menu de base en appuyant sur  , seul le Menu de base s'affiche lorsque vous appuyez de nouveau sur  . Pour accéder aux autres menus, sélectionnez l'option Menu avancé (page 35).</li> </ul>
<b>Seul les canaux provenant du téléviseur apparaissent à l'écran</b>	<ul style="list-style-type: none"> <li>❑ Vérifiez que vous n'avez pas réglé les étiquettes vidéo des appareils raccordés pour que le téléviseur saute ces entrées (menu Réglage, page 34).</li> </ul>
<b>Le téléviseur doit être nettoyé.</b>	<ul style="list-style-type: none"> <li>❑ Nettoyez le téléviseur avec un chiffon sec et doux. N'utilisez jamais de solvants puissants, comme un diluant ou de la benzine, pouvant endommager le revêtement du châssis.</li> </ul>



## Informations complémentaires

---

<b>Problème</b>	<b>Solutions possibles</b>
<b>Oubli du mot de passe du contrôle parental</b>	<input type="checkbox"/> Saisissez le mot de passe principal dans l'écran du mot de passe, à savoir 4357. Vous devez créer un nouveau mot de passe après avoir utilisé le mot de passe principal. Il ne peut pas être utilisé pour débloquer des canaux bloqués.
<b>Vous avez perdu votre télécommande</b>	<input type="checkbox"/> Les commandes du panneau avant permettent d'accéder aux menus, de changer de canal, de régler le volume et de commuter les entrées vidéo (page 2). Contactez le détaillant Sony le plus près de chez vous pour commander une télécommande de rechange. Les résidents des États-Unis peuvent également contacter le "Sony Direct Accessory and Part Center" au 1-800-488-7669.
<b>Une fenêtre noire apparaît à l'écran</b>	<input type="checkbox"/> Une option de texte a été sélectionnée dans le menu de Réglage et aucun texte n'est disponible (page 34). Pour désactiver cette fonction, sélectionner Non dans l'option Sous-titres (Caption Vision). Pour obtenir les sous-titres, sélectionner CC1-4 au lieu de Text1-4.
<b>Le téléviseur ne se met pas sous tension après avoir été débranché et le indicateur (LED) de la minuterie clignote</b>	<input type="checkbox"/> Appuyez encore une fois sur la touche POWER de la télécommande ou sur le panneau avant du téléviseur.

*Pour toute question supplémentaire au sujet du fonctionnement de votre téléviseur Sony non abordée dans ce mode d'emploi, composez le (416) 499-SONY (7669) (Canada uniquement) ou contactez le "Customer Information Services Center" au 1-800-222-SONY (7669) (États-Unis uniquement).*

## Spécifications

### Pour tous les modèles (sauf ceux portant la mention contraire)

Système de télévision	Norme de télévision américaine / NTSC
Couverture des canaux	VHF : 2-13/UHF : 14-69/CATV : 1-125
Antenne	Borne d'antenne externe de 75 ohms pour VHF/UHF
Tube cathodique	Tube FD Trinitron®
Alimentation	120 V, 60 Hz
Accessoires fournis	Piles AA (R6) (2) Télécommande RM-Y180 (1)
Accessoires en option	Câbles de connexion VMC-810S/820S, VMC-720M, YC-YC-15V/30V, RK74A Mixeur U/V EAC-66 Meuble de téléviseur : SU-27FS1 pour le KV-27FS100, SU-32FS1 pour le KV-32FS100, SU-36FS1 pour le KV-36FS100.

#### KV-27FS100

Taille de l'écran	Taille visible de l'écran : 679 mm (27 po) en diagonale Taille réelle de l'écran : 736,6 mm (29 po) en diagonale		
Entrées / sorties	Entrées	1 vidéo, 1 audio (panneau avant) 2 vidéo, 2 audio (panneau arrière) 1 S VIDEO 1 RF 1 Y, Pb,Pr, 1 audio	Sorties 1 AUDIO OUT
Sortie du haut-parleur	10 W x 2		
Consommation électrique	180 W en fonctionnement 1 W en veille		
Dimensions (W/H/D)	768 x 589 x 497 mm (30 <sup>1</sup> / <sub>4</sub> x 23 <sup>1</sup> / <sub>4</sub> x 19 <sup>5</sup> / <sub>8</sub> po)		
Poids	49,5 kg (109 livres 2 onces)		

#### KV-32FS100

Taille de l'écran	Taille visible de l'écran : 803 mm (32 po) en diagonale Taille réelle de l'écran : 863,6 mm (34 po) en diagonale		
Entrées / sorties	Entrées	1 vidéo, 1 audio (panneau avant) 2 vidéo, 2 audio (panneau arrière) 1 S VIDEO 1 RF 1 Y, Pb,Pr, 1 audio	Sorties 1 AUDIO OUT
Sortie du haut-parleur	10 W x 2		
Consommation électrique	190 W en fonctionnement 1 W en veille		
Dimensions (W/H/D)	898 x 696 x 576 mm (35 <sup>3</sup> / <sub>8</sub> x 26 <sup>3</sup> / <sub>8</sub> x 22 <sup>5</sup> / <sub>8</sub> po)		
Poids	75 kg (165 livres 6 onces)		

#### KV-36FS100

Taille de l'écran	Taille visible de l'écran : 911 mm (36 po) en diagonale Taille réelle de l'écran : 965,2 mm (38 po) en diagonale		
Entrées / sorties	Entrées	1 vidéo, 1 audio (panneau avant) 2 vidéo, 2 audio (panneau arrière) 1 S VIDEO 1 RF 1 Y, Pb,Pr, 1 audio	Sorties 1 AUDIO OUT
Sortie du haut-parleur	10 W x 2		
Consommation électrique	190 W en fonctionnement 1 W en veille		
Dimensions (W/H/D)	985 x 774 x 633 mm (38 <sup>3</sup> / <sub>4</sub> x 30 <sup>1</sup> / <sub>4</sub> x 25 po)		
Poids	98,4 kg (216 livres 8 onces)		

La conception et les caractéristiques techniques sont sujettes à modification sans préavis.



# Index

- 16:9 amélioré **34**
- A**
  - Aigu **23**
  - Auto programmation **17, 26**
  - Auto SAP **23**
- B**
  - Balance **23**
- C**
  - Câble **25**
  - Canal fixe **25**
  - Canaux préférés **25**
  - Caption Vision (sous-titres) **34**
  - Caractéristiques du téléviseur **1**
  - Couleur **22**
- D**
  - Démo **34**
  - DISPLAY **5**
- E**
  - Effet
    - Ambiophonie **23**
    - Non **23**
  - Étiquette vidéo **34**
- G**
  - Grave **23**
  - Guide de dépannage **40**
- H**
  - Haut-parleur **24**
  - Heure **33**
- I**
  - Image **22**
- L**
  - Langue **34**
  - Légende de canal **26**
  - Luminosité **22**
- M**
  - Menus
    - Audio **23**
    - De base **35**
    - Heure **33**
    - Parent **27**
    - Réglage des canaux **25**
    - Vidéo **22**
  - Menu avancé **35**
  - Minuterie 1 et Minuterie 2 **33**
  - Mode
    - Éclatant **22**
    - Film **22**
    - Sports **22**
    - Standard **22**
- MTS
  - Auto SAP **23**
  - Mono **23**
  - Stéréo **23**
- N**
  - Netteté **22**
  - Nuancé **22**
- P**
  - Panneau arrière du téléviseur **7**
  - Panneau avant du téléviseur **2**
- R**
  - Raccordements
    - Câble ou antenne **8**
    - Raccordement d'une chaîne audio **15**
    - Raccordement d'un caméscope **15**
    - Raccordement d'un lecteur de DVD **14**
    - Raccordement du téléviseur à un magnétoscope **9**
    - Téléviseur et décodeur de câble **10**
    - Téléviseur et récepteur satellite **12**
    - Téléviseur, magnétoscope et décodeur de câble **11**
    - Téléviseur, récepteur satellite et magnétoscope **13**
  - Réglage du classement
    - Classement anglais **32**
    - Classement des films **30**
    - Classement français **32**
    - Classement de télé **30**
    - Classement U.S.A. **32**
    - Non-classée **31**
  - Rotation **34**
- S**
  - Saut/Ajout canal **26**
  - SLEEP **3**
  - Sortie audio **24**
  - Spécifications **43**
- T**
  - Télécommande
    - Piles **2**
    - Programmation **37**
    - Utilisation **3-5**
  - Température de la couleur **22**
- V**
  - VM **22**

























**SONY**<sup>®</sup>

4-089-081-41



**FD Trinitron**  
**WEGA**<sup>®</sup>

---

Manual de Instrucciones

Lea este manual antes de operar el producto

KV-29FS100  
KV-34FS100  
KV-38FS200





# ADVERTENCIA

Para evitar el riesgo de incendio o descarga eléctrica, no exponga el televisor a la lluvia o humedad.



Este símbolo señala al usuario la presencia de voltaje peligroso sin aislamiento en el interior del aparato de tal intensidad que podría presentar riesgo de descarga eléctrica.



Este símbolo indica al usuario que el manual que acompaña a este aparato contiene instrucciones importantes referentes a su funcionamiento y mantenimiento.

## Nota para el instalador de CATV

Esta nota pretende llamar la atención del instalador del sistema CATV en relación con el artículo 820-40 de la NEC que proporciona las pautas para una adecuada conexión a tierra y, en particular, especifica que el cable de conexión a tierra debe estar conectado al sistema de toma de tierra del edificio lo más cerca posible de la entrada del cable.

## PRECAUCIONES DE SEGURIDAD

- Utilice el televisor con ca (corriente alterna) como se menciona a continuación para todos los países excepto en donde se indique:  
ca 120 V 60 Hz  
ca 220 V 50/60 Hz (Chile, Perú, Bolivia)
- Una terminal del enchufe es más ancha que la otra para garantizar la seguridad y solo se podrá introducir en la toma de corriente de una manera (sólo los modelos con ca 120 V). Si no puede insertar completamente el enchufe en la toma, póngase en contacto con su proveedor.
- Si se introduce algún objeto sólido o líquido en el televisor, desconéctelo y haga que sea revisado por personal especializado antes de volver a utilizarlo.

## PRECAUCIÓN

PARA EVITAR DESCARGAS ELÉCTRICAS, INTRODUZCA EL ENCHUFE EN EL TOMACORRIENTE POR COMPLETO, CON EL CONTACTO ANCHO DEL ENCHUFE EN LA RANURA ANCHA DEL TOMACORRIENTE.

Al usar videojuegos, computadoras y productos similares con el televisor, mantenga los ajustes de brillo y contraste a un nivel moderado. Si una imagen inmóvil permanece en la pantalla durante un periodo prolongado con elevada intensidad de brillo o contraste, la imagen podría quedar grabada en la pantalla en forma permanente. Igualmente, ver continuamente el mismo canal de televisión podría dejar grabada en la pantalla el logotipo de la emisora. La garantía no cubre este tipo de anomalías, ya que se deben al mal uso del aparato.



Para reducir el riesgo de descarga eléctrica, no utilice el enchufe polarizado con un cable de extensión, un receptáculo ni otras tomas, a menos que las terminales estén bien insertadas y no queden expuestas.



Se advierte que cualquier cambio o modificación que no se apruebe de modo explícito en este manual podría anular su autorización para utilizar este equipo.

## NOTIFICACIÓN

Este aparato ha sido debidamente probado, comprobándose que cumple con los límites impuestos a dispositivos digitales Clase B de acuerdo con la Sección 15 de las normas de la FCC. Estos límites se establecieron para ofrecer protección razonable contra interferencias perjudiciales en las instalaciones residenciales. Este aparato genera, usa y puede emitir energía radioeléctrica. De no instalarse y utilizarse de acuerdo con las instrucciones correspondientes, podría producir interferencias perjudiciales en las radiocomunicaciones. No obstante, no puede garantizarse que no se produzcan estas interferencias en una instalación determinada. Si este aparato llega a interferir en la recepción de radio o televisión, lo que podrá comprobarse encendiendo y apagando el aparato, se recomienda al usuario intentar corregir la interferencia mediante una o más de las siguientes medidas:

- Reoriente o cambie de lugar las antenas receptoras.
- Aumente la distancia que separa este aparato del receptor afectado.
- Conecte el aparato en una toma de corriente de un circuito distinto al que esté conectado el receptor que está afectado.
- Consulte con el distribuidor o solicite los servicios de un técnico capacitado en radio y televisión. Cualquier cambio o modificación que no se detalla expresamente en el presente manual podría invalidar su autorización para emplear este aparato.

## Protección del televisor

- Para evitar el sobrecalentamiento interno, no obstruya los orificios de ventilación.
- No instale el televisor en un lugar con temperatura elevada, humedad, exceso de polvo o donde puedan producirse vibraciones.

## Nota sobre Caption Vision

Este receptor de televisión proporciona pantalla de televisión con visualización de subtítulos de acuerdo con el punto § 15.119 del reglamento de la FCC.

El uso del televisor con finalidades distintas a la visualización privada de emisiones de programas en UHF o VHF o transmisiones vía cable dirigidas al público en general puede requerir la autorización de la compañía de emisión por cable y/o del propietario del programa.

## Información para el propietario

Los números de serie y modelo están situados en la portada de este manual y en la parte posterior del televisor.

## Marcas comerciales y derechos de autor

ENERGY STAR® es una marca registrada.



En calidad de compañía asociada a ENERGY STAR®, Sony ha determinado que este producto o modelo de producto cumple con las directrices de uso eficiente de energía de ENERGY STAR®.

WEGA, FD Trinitron, Caption Vision y Auto Volumen son marcas registradas de Corporación Sony.

# Normas importantes sobre seguridad

Para su protección, lea detenidamente estas instrucciones y guarde este manual para futuras consultas.

Lea cuidadosamente todas las advertencias y precauciones y siga las instrucciones inscritas en el televisor o descritas en el manual de instrucciones o de reparación.

## ADVERTENCIA

Para protegerse contra daños personales, siga las precauciones de seguridad básicas durante la instalación, la utilización y el mantenimiento del televisor indicadas a continuación.

## Uso

### Fuentes de alimentación

Este televisor solamente deberá alimentarse con el tipo de fuente de alimentación indicado en la etiqueta de serie/modelo. Si no está seguro sobre el tipo de red eléctrica de su hogar, consulte a su proveedor o a la compañía de suministro eléctrico local. En caso de un televisor diseñado para alimentarse con baterías, consulte su manual de instrucciones.



### Conexión a tierra o polarización

Este aparato cuenta con cable eléctrico con clavija polarizada (con una terminal más ancha que la otra), o con tres terminales (la tercera es para la conexión). Siga las instrucciones indicadas a continuación:

### Para los equipos con un enchufe de cable de alimentación de ca polarizado

El enchufe se introduce en la toma de corriente en una única dirección. Se trata de una característica de seguridad. Si no puede insertar completamente el enchufe en la toma, intente girar el enchufe. Si sigue teniendo problemas para insertar el enchufe, póngase en contacto con su electricista para que le instale una toma adecuada. No ponga a prueba la finalidad de seguridad del enchufe polarizado forzándolo.



### Advertencia alternativa

### Para los equipos con un enchufe de ca con tres cables de conexión de tierra

Este enchufe únicamente se acoplará a una toma de corriente de conexión a tierra. Se trata de una característica de seguridad. Si no puede insertar el enchufe en la toma, póngase en contacto con su electricista para que le instale una toma adecuada. No ponga a prueba la seguridad del enchufe de conexión a tierra.

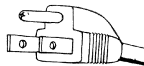

### Sobrecarga

No sobrecargue las tomas de pared, los cables de extensión ni los receptáculos más allá de su capacidad, puesto que podría producirse un incendio o una descarga eléctrica. Apague siempre el aparato cuando no lo utilice. Si no va a utilizar el aparato durante un tiempo prolongado, desconéctelo de la toma de pared como precaución ante la posibilidad de que se produzca un mal funcionamiento interno que pueda provocar un incendio.

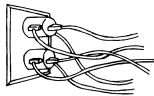

No desconecte la antena ni el cable de alimentación en caso de tormenta. Los relámpagos podrían descargar mientras sujeta el cable y provocarle lesiones graves. Apague el televisor y espere que el tiempo mejore.



## Introducción de objetos y líquidos

No introduzca objetos de ningún tipo a través de las ranuras del gabinete, ya que podrían tocar puntos de tensión peligrosa o provocar cortocircuitos de piezas, lo que podría resultar en incendios o descargas eléctricas. No derrame nunca ningún tipo de líquido sobre el televisor.



## Accesorios

No utilice ningún accesorio no recomendado por el fabricante, ya que podría ser peligroso.

No coloque ningún tipo de objetos, especialmente objetos pesados, encima del aparato. Podrían caerse del aparato y causar lesiones.



## Limpieza

Antes de limpiar el televisor, desconéctelo de la alimentación. No utilice limpiadores líquidos ni aerosoles. Para limpiar el exterior del televisor, emplee un paño ligeramente humedecido en agua.



Si se produce un ruido continuo o intermitente en el interior del aparato de televisión mientras está en funcionamiento, desconecte el televisor y póngase en contacto con el proveedor o con el servicio de asistencia técnica. Es normal que algunos aparatos de televisión produzcan ocasionalmente este tipo de ruidos, especialmente cuando se conectan y desconectan.

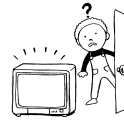

## Instalación

Para levantar o mover el aparato siempre se deberá hacer entre dos o más personas. El aparato es pesado y la superficie inferior es plana. Si intenta mover el aparato sin ayuda o lo manipula de forma insegura, puede producirse lesiones graves. Instale el aparato sobre una superficie plana y estable.

## Agua y humedad

No utilice aparatos de alimentación eléctrica cerca del agua — por ejemplo, cerca de una bañera, un lavabo, un fregadero o una lavadora, en un sótano húmedo, ni cerca de una piscina, etc.



## Colocación

No coloque el televisor sobre una mesita con ruedas, un pedestal, una mesa o un estante inestable. El televisor podría caer, causando daños serios a niños, adultos y al propio televisor. Utilice solamente la mesita de ruedas o soporte recomendado por el fabricante para el modelo específico. La combinación de un televisor y un mueble con ruedas deberá moverse con cuidado. Las paradas bruscas, la fuerza excesiva y las superficies desiguales pueden hacer que el aparato y el mueble volqueen.

Desconecte todos los cables del aparato antes de intentar moverlo.

No permita que niños o animales se suban encima del aparato o lo empujen. El aparato podría caerse y causar lesiones graves.



## Ventilación

Las ranuras y aberturas en la parte posterior o inferior del televisor son para permitir la ventilación necesaria. Para asegurar la operación fiable del televisor y protegerlo contra el sobrecalentamiento, estas ranuras y aberturas no deberán cubrirse ni bloquearse nunca.

No tape las ranuras ni aberturas con paños ni otros materiales.



No bloquee las ranuras ni aberturas colocando el televisor sobre una cama, sofá, alfombra u otras superficies similares.

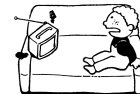

- No coloque el televisor en un lugar cerrado, como en un librero o un mueble empotrado, a menos que esté adecuadamente ventilado.



- No coloque el televisor cerca, ni sobre un radiador o una salida de aire caliente, ni expuesto a la luz solar directa.



### Protección del cable de alimentación

No permita que ningún objeto quede sobre el cable de alimentación, ni coloque el televisor donde el cable pueda quedar sometido a desgaste o presión.

### Conexión a tierra o polarización

Este aparato puede estar equipado con un enchufe de línea de corriente alterna polarizado (con una terminal más ancha que la otra). El enchufe sólo se puede introducir en la toma de corriente en una dirección. Se trata de una característica de seguridad. Si no puede insertar completamente el enchufe en la toma, intente girarlo. Si sigue teniendo problemas para introducir el enchufe, póngase en contacto con su electricista para que sustituya la toma obsoleta. No ponga a prueba la seguridad del enchufe polarizado.

### Antenas

#### Conexión a tierra de una antena exterior

Para instalar una antena exterior, siga los procedimientos que se indican a continuación. Los sistemas de antenas exteriores no deben situarse cerca de líneas eléctricas o circuitos de alimentación o luz eléctrica, o bien donde pueda entrar en contacto con dichas líneas eléctricas o circuitos.

CUANDO INSTALE UN SISTEMA DE ANTENA EXTERIOR, EXTREME LAS PRECAUCIONES Y MANTÉNGALO ALEJADO DE DICHAS LINEAS ELÉCTRICAS O CIRCUITOS, DADO QUE EL CONTACTO PUEDE RESULTAR FATAL.

Asegúrese de que el sistema de antena tiene conexión a tierra para proporcionar protección contra los incrementos de voltaje y el aumento de las cargas estáticas. El apartado 810 del Código Eléctrico Nacional (NEC) en EE.UU. y el apartado 54 del Código Eléctrico de Canadá proporcionan información relativa a la conexión a tierra adecuada del mástil y de la estructura de soporte, la conexión a tierra del cable de conexión a la unidad de descarga de la antena, el tamaño de los conductores de la conexión a tierra, la ubicación de la unidad de descarga de la antena, la conexión de los electrodos de conexión a tierra y los requisitos de los electrodos de conexión a tierra.

#### Conexión a tierra de la antena de acuerdo con el Código Eléctrico Nacional, ANSI/NFPA 70

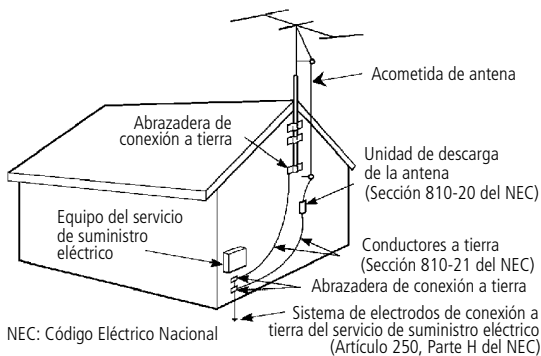

### Rayos

Para mayor protección del receptor de televisión durante una tormenta con rayos o cuando no se utiliza durante largos periodos de tiempo, desconéctelo de la toma de pared y desconecte la antena. Con ello evitará que los rayos y los incrementos de voltaje dañen el receptor.

## Reparación

### Daños que requieren reparación

Desconecte el aparato de la toma de pared y haga que sea revisado por personal calificado cuando se produzcan las siguientes condiciones:

- Si el cable de alimentación o el enchufe están dañados o deshilachados.

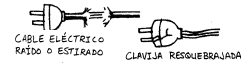

- Si se ha vertido líquido en el interior del aparato o si se han caído objetos en el interior del producto.



- Si el aparato se ha expuesto a lluvia o agua.



- Si el aparato se ha caído y ha sufrido golpes excesivos o si se ha dañado la unidad.



- Si el aparato no funciona con normalidad al seguir las instrucciones del manual. Ajuste solamente los controles que se especifican en el manual de instrucciones. El ajuste inadecuado de otros controles puede provocar daños y a menudo requerirá mucho trabajo por parte de un técnico calificado para restablecer el funcionamiento normal del aparato.



- Si el aparato muestra un cambio de rendimiento significativo, debe repararse.

### Asistencia técnica

No intente reparar por sí mismo el aparato ya que al abrir el gabinete se vería expuesto a tensiones peligrosas y otros riesgos. Solicite los servicios de personal de reparación calificado.



### Piezas de reemplazo

Si necesita piezas de reemplazo, asegúrese de que el técnico certifique por escrito que ha utilizado piezas de reemplazo especificadas por el fabricante con las mismas características que las piezas originales. El uso de piezas no autorizadas puede provocar incendios, descargas eléctricas y otros peligros.



### Comprobación de seguridad

Después de realizar cualquier reparación del aparato, solicite al técnico de la reparación que realice comprobaciones rutinarias de seguridad (como especifica el fabricante) para determinar si el aparato se encuentra en condiciones seguras de funcionamiento y certificarlo. Cuando el aparato llega al final de su vida útil, debe desecharse adecuadamente para evitar una implosión del tubo de la imagen. Consulte a un técnico de reparación calificado para depositar el aparato.





# Contenido

## Introducción

Características del televisor FD Trinitron WEGA® .....	1
Acerca de este manual .....	2
Baterías para el control remoto .....	2
Controles del panel frontal .....	2
Uso del control remoto.....	3

## Conexión del televisor

Panel posterior del televisor.....	5
Conexiones básicas .....	7
Conexiones del decodificador.....	8
Conexión de equipo adicional .....	10

## Uso de las funciones básicas

Ajuste automático del televisor .....	17
Acceso rápido a los menús .....	18
Uso de Imagen dentro de una Imagen (PIP).....	20
Ajustes que pueden afectar el uso de Imagen dentro de una Imagen (PIP) .....	22

## Uso de los menús

Para acceder a un menú.....	23
Uso del Menú Video.....	24
Uso del Menú Audio .....	25
Uso del Menú Canal .....	27
Uso del Menú Bloqueo de Canal .....	29
Uso del Menú Timer (Reloj) .....	30
Uso del Menú Ajustes .....	31
Uso del Menú Básico .....	32

## Información adicional

Programación del control remoto.....	33
Solución de problemas.....	36
Especificaciones.....	38

<b>Índice alfabético</b> .....	39
--------------------------------	----



# Introducción

Gracias por la compra del televisor FD Trinitron WEGA® de Sony. Antes de utilizar este manual, compruebe el número de modelo situado en la parte posterior del televisor o en la portada de este manual.

## Características del televisor FD Trinitron WEGA®

Algunas de las características que disfrutará son:

- ❑ **FD Trinitron CRT Plano** — Su cinescopio tecnológicamente avanzado ofrece una imagen con precisión absoluta y notable detalle.
- ❑ **Entradas Y, P<sub>B</sub>, P<sub>R</sub>** — Conexión de entrada de video para una calidad de imagen superior (480i únicamente).
- ❑ **Surround** — Simula el sonido con calidad de sala de cine para programas estéreo.
- ❑ **Función de bloqueo de canales** — Una herramienta para ayudar a que los padres controlen lo que ven sus hijos bloqueando algunos canales.
- ❑ **Imagen dentro de una Imagen (PIP)** — Le permite ver dos canales al mismo tiempo. (Sólo en los modelos KV-38FS200).
- ❑ **Canales Favoritos** — Acceso instantáneo a sus canales favoritos con sólo presionar un botón.
- ❑ **Info** — Una función nueva y práctica que muestra el nombre y el tiempo restante del programa en curso, si la información está disponible.
- ❑ **Control Remoto Universal** — Puede programar el control remoto para operar con él su decodificador de cable, videograbadora, receptor de satélite digital o reproductor de DVD.
- ❑ **Energy Star®** — Cumple con las directivas Energy Star de eficiencia en el uso de la energía eléctrica.
- ❑ **Controles del Panel Frontal** — Permiten el acceso a los menús de pantalla sin el control remoto.
- ❑ **Entradas de A/V frontales** — Conexión rápida para videojuegos, cámaras de video y equipos estéreo/mono.
- ❑ **Muting (Silenciamiento automático)** — Función diseñada para silenciar automáticamente el televisor cuando no se reciben señales.



## Acerca de este manual

Este manual proporciona instrucciones para ayudarle a disfrutar de su nuevo televisor. Muestra como conectarlo a la antena o al cable, al decodificador de cable, a la videograbadora, al reproductor de DVD, al receptor de satélite, al sistema estéreo o a la cámara de video. Una vez conectado, siga las instrucciones y utilice el control remoto para acceder a los menús de pantalla.

## Baterías para el control remoto

Introduzca dos baterías de tipo AA (R6) (incluidas) en el control remoto como se muestra en la siguiente ilustración.

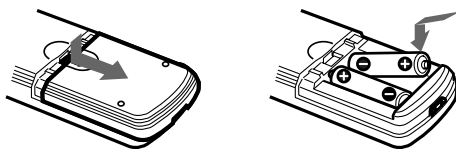

✎ En condiciones de uso normales, las baterías tienen una duración máxima de seis meses. Si el control remoto no funciona correctamente, es posible que las baterías estén gastadas.

✎ Si no va a utilizar el control remoto durante largo tiempo, quite las baterías para evitar posibles daños por fugas.

## Controles del panel frontal

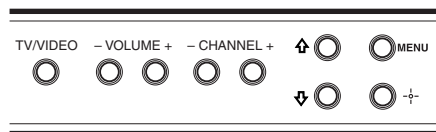

Los controles del panel de audio/video frontal le permiten acceder al menú sin utilizar el control remoto.

- ❑ Presione para que aparezca el menú en pantalla.
- ❑ Use los botones y del panel frontal de audio/video en lugar del control remoto.
- ❑ Utilice el botón del panel frontal de audio/video para navegar a través de los menús y después seleccione una opción. Los controles del panel frontal también le permiten cambiar los canales, ajustar el volumen y cambiar las entradas de video.

✎ Para navegar por los menús con el control remoto, consulte "Uso de los menús" en la página 23.

## Uso del control remoto

Esta sección le muestra cómo utilizar todos los botones del control remoto.

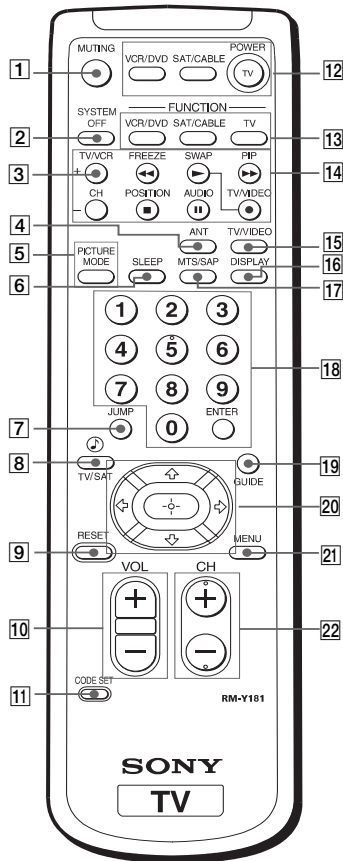

Botón	Descripción
<b>1</b> <b>MUTING</b> <i>Silenciamiento automático</i>	Presione para desactivar el sonido. Presiónelo de nuevo o presione  para restaurar el sonido.
<b>2</b> <b>SYSTEM OFF</b> <i>Apagar sistema</i>	Presiónelo para apagar todos los aparatos que estén programados en el control remoto, consulte "Programación del control remoto" en la página 33.
<b>3</b> <b>TV/VCR</b>	Presiónelo para cambiar entre los modos de televisión y videograbadora. Si su videograbadora no es marca Sony, tendrá que programar el control remoto para que pueda reconocer su videograbadora. Para más detalles, consulte "Programación del control remoto" en la página 33.
<b>4</b> <b>ANT (antena)</b>	Presiónelo para cambiar la entrada de VHF/UHF a AUX.
<b>5</b> <b>PICTURE MODE</b> <i>Modo de imagen</i>	Presione repetidamente para recorrer las modalidades de imagen disponibles: Vívido, Estándar, Película y Deportes. Esta función se encuentra también en el Menú de Video. Consulte "Uso del Menú de Video" en la página 24 para más detalles.
<b>6</b> <b>SLEEP</b> <i>Apagado automático</i>	Presione repetidamente hasta que aparezca el número de minutos (15, 30, 45, 60 o 90) que quiera tener encendido el televisor antes de apagarse automáticamente. Para cancelar este modo, presione el botón hasta que aparezca Sleep No. Estando activado el modo de Sleep, presiónelo una vez para ver el tiempo restante.
<b>7</b> <b>JUMP</b> <i>Alternar</i>	Presione para alternar entre dos canales. El televisor cambia del canal actual al último canal seleccionado.
<b>8</b> <b>TV/SAT</b>	Presione para alternar entre las entradas TV y SAT (satélite) cuando esté en modo SAT de la barra FUNCTION (función).
	Presione para acceder directamente a los ajustes de Efecto de Audio (Surround, No), cuando el control remoto esté en modo TV de la barra FUNCTION (función). Consulte "Uso del Menú Audio" en la página 25 para más detalles.
<b>9</b> <b>RESET</b> <i>Restablecer</i>	Presiónelo para volver a la configuración de fábrica cuando esté en un menú de pantalla.
<b>10</b> <b>VOL (volumen)</b>	Presione (+) o (-) para ajustar el volumen.
<b>11</b> <b>CODE SET</b> <i>Juego de códigos</i>	Programe con él su control remoto para que pueda operar el equipo de video conectado al televisor, consulte "Programación del control remoto" en la página 33.
<b>12</b> <b>Botones POWER</b> <i>Botones de encendido/apagado</i>	Presiónelos para encender y apagar su televisor o el equipo conectado de audio/video que tenga programado en el control remoto, consulte "Programación del control remoto" en la página 33.

El control remoto que se muestra (RM-Y181) corresponde a los modelos KV-38FS200. El control remoto de los modelos KV-29FS100 y KV-34FS100 (RM-Y180), no tienen los botones con funciones de Imagen dentro de una Imagen (PIP).

Botón	Descripción
<b>13</b> <b>Botones FUNCTION</b> <i>Botones de función</i>	Presiónelos para seleccionar el equipo conectado (televisor, videograbadora/reproductor de DVD, receptor de satélite/cable) que desee utilizar con el control remoto.
<b>14</b> <b>PIP (Imagen dentro de una Imagen)</b>	Presiónelos para operar la función PIP. Consulte "Uso de Imagen dentro de una Imagen (PIP)" en la página 20.
<b>VCR (Funcionamiento)</b>	Presione para operar su videograbadora. La videograbadora deberá estar programada en el control remoto, consulte "Programación del control remoto" en la página 33.
<b>REC</b> <i>Grabar</i>	Presione el botón  y el botón  (arriba a la izquierda) al mismo tiempo para grabar programas con su videograbadora (el control remoto debe haberse programado para poder utilizar esta opción).
	Reproducir.
	Regresar.
	Avance rápido.
	Parar.
	Pausa. Presiónelo de nuevo para reanudar la reproducción normal.
<b>15</b> <b>TV/VIDEO</b>	Presiónelo para alternar entre las entradas de video disponibles.
<b>16</b> <b>DISPLAY</b> <i>Mostrar</i>	Presione una vez para ver la hora actual, el nombre del canal (si se ha definido) y el número del canal. Presiónelo nuevamente para desactivar la función. Consulte "Uso del Menú Timer (Reloj)" en la página 30 para conocer más detalles.
<b>17</b> <b>MTS/SAP</b>	Presiónelo para recorrer las opciones de Sonido Multicanal del Televisor (MTS): Estéreo, Mono y Auto SAP ( Segundo Programa de Audio).
<b>18</b> <b>Botones 0-9 y ENTER (introducir)</b>	Presiónelos para cambiar los canales directamente. El canal cambia después de 2 segundos.
<b>19</b> <b>GUIDE</b> <i>Guía</i>	Presiónelo para mostrar la guía de programas de su antena de satélite.
<b>20</b> 	Presione los botones con flechas para mover el cursor en los menús en pantalla. Presione el botón central para seleccionar una opción o acceder a ella.
<b>21</b> <b>MENU</b>	Presione este botón para ver el menú en pantalla. Presiónelo de nuevo para salir del menú en cualquier momento.
<b>22</b> <b>CH (canal)</b>	Presione para cambiar de canal. Para navegar rápidamente a través de los canales, presione y manténgase así el botón CH+ o CH-.

 Para obtener información sobre los botones de operación de Imagen dentro de una Imagen (PIP), consulte la página 21.

 Si pierde su control remoto, consulte la página 37.

# Conexión del televisor

Lea esta sección antes de instalar el televisor por primera vez. Esta sección hace referencia a las conexiones básicas, así como a cualquier otro equipo opcional que conecte.

 Los paneles frontal y posterior que se encuentran ilustrados en este manual corresponden a los modelos KV-38FS200. Los modelos KV-29FS100 y KV-34FS100, no tienen la entrada AUX (auxiliar) y la salida TO CONVERTER (al convertidor).

## Panel posterior del televisor

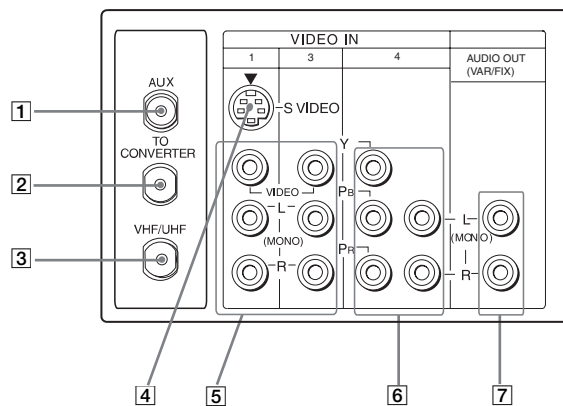

Entrada/Salida	Descripción
<b>1</b> <b>AUX</b> <i>Auxiliar</i>	Esta es una entrada que le permite ver los canales locales y de cable si su servicio de cable no ofrece los primeros. Usted puede cambiar entre los canales locales y los del cable si oprime ANT en el control remoto. Los aparatos conectados a la entrada AUX no podrán verse en Imagen dentro de una Imagen (PIP).
<b>2</b> <b>TO CONVERTER</b> <i>Al convertidor</i>	Esta es una salida de VHF/UHF que le permite programar su televisor para cambiar entre canales codificados (mediante decodificador) y los canales normales de televisión por cable. Use esta salida en lugar de un conector en Y para obtener una mejor calidad de imagen cuando necesite cambiar entre canales de cable codificados y decodificados.
<b>3</b> <b>VHF/UHF</b>	Esta entrada establece una conexión con el cable o la antena de VHF/UHF.

<b>Entrada/Salida</b>	<b>Descripción</b>
<b>4 S VIDEO</b>	Esta entrada establece una conexión con la toma S VIDEO OUT (salida de S VIDEO) de la videgrabadora o de otro equipo de video con S VIDEO. S VIDEO proporciona una mejor calidad de imagen que las tomas VHF/UHF o la toma de entrada de video. Como S VIDEO no proporciona sonido, debe mantener conectados los cables de audio.
<b>5 AUDIO L(MONO), R/VIDEO</b> <i>Audio izquierda (mono), derecha/Video</i>	Esta entrada establece una conexión con las tomas de salida de AUDIO/VIDEO de la videgrabadora o de otro equipo de video. En el panel frontal del televisor existe una tercera toma de entrada de video (VIDEO 2). Estas tomas de entrada de AUDIO/VIDEO proporcionan una mejor calidad de imagen que la toma VHF/UHF.
<b>6 Y, P<sub>B</sub>, P<sub>R</sub>/ L(MONO), R</b> <i>Y, P<sub>B</sub>, P<sub>R</sub>/izquierda (mono), derecha</i>	Esta es una entrada que se conecta a las tomas de entrada de video para componentes Y, P <sub>B</sub> , P <sub>R</sub> y a las tomas de AUDIO L(izquierda)(MONO), R(derecha) del reproductor de DVD o a la caja decodificadora digital (480i únicamente).
<b>7 AUDIO OUT (VAR/FIX) L(MONO), R</b> <i>Salida de audio (variable/fija) izquierda (mono), derecha</i>	Esta es una salida que se conecta a las tomas de entrada de AUDIO L(izquierda)(MONO), R(derecha) del equipo de audio. Puede escuchar el sonido del televisor con el equipo de sonido.

## Conexiones básicas

### Televisor con antena interior/externo o cable CATV

Dependiendo del cable que tenga, elija una de las siguientes conexiones:

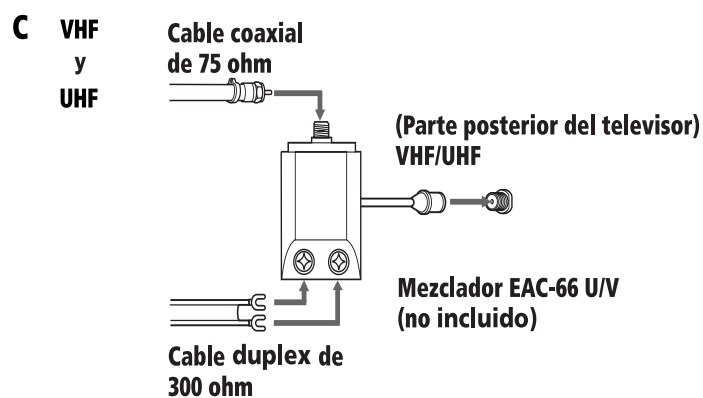
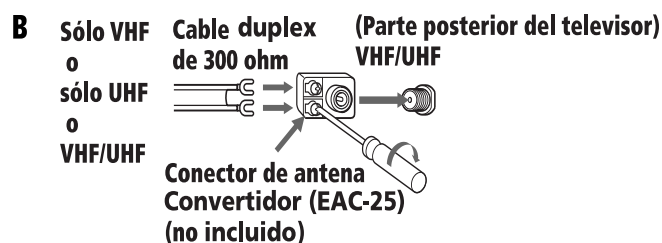
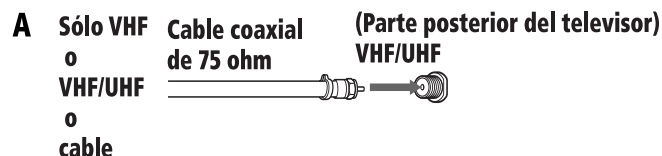

 Si conecta el televisor a una antena interior o exterior, es posible que deba ajustar la orientación de la antena para obtener una mejor recepción.

## Conexiones del decodificador

Algunos sistemas de televisión por cable usan señales codificadas que requieren de un decodificador para poder ver todos los canales. Si está suscrito a ese tipo de servicio de cable, utilice esta conexión. Las señales codificadas que lleguen al televisor desde el decodificador no pueden verse en Imagen dentro de una Imagen (PIP). Si algunos de sus canales están codificados, tome en consideración la posibilidad de utilizar la conexión de Decodificador y cable.

### Decodificador y televisor

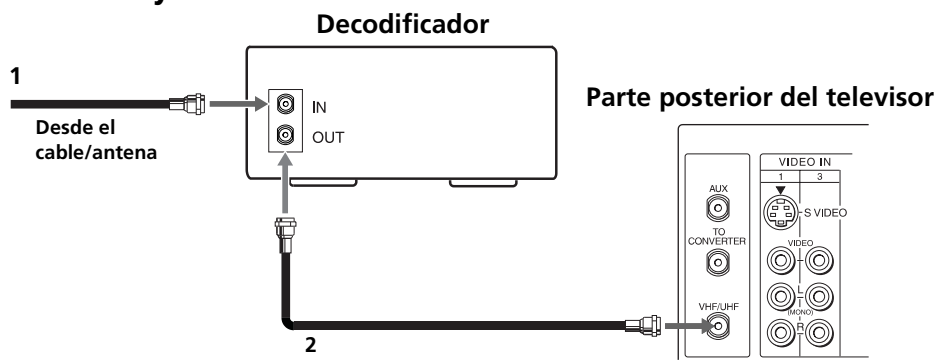

- 1** Conecte el cable coaxial de su servicio de cable a la toma IN (entrada) del decodificador.
- 2** Conecte un cable coaxial (no incluido) desde la toma OUT (salida) del decodificador a la toma VHF/UHF del televisor.

 Si desea controlar toda la selección de canales con el decodificador, es aconsejable utilizar la función Fijar Canal ajustando el televisor en el canal 3 o el 4 (consulte la página 27).

### Decodificador y cable

Utilice esta conexión si está suscrito a un sistema de cable que codifique algunos canales (canales de pago) pero no todos. Esta configuración le permite utilizar el control remoto para:

- ❑ Cambiar de canal por medio del decodificador cuando esté recibiendo una señal codificada.
- ❑ Cambiar de canal por medio de su televisor.

Esta conexión también le permite utilizar la función Imagen dentro de una Imagen (PIP) cuando esté viendo canales no codificados que lleguen directamente a su televisor por el cable. Las señales codificadas que lleguen desde el decodificador no pueden verse en Imagen dentro de una Imagen (PIP). Para obtener más información sobre la función Imagen dentro de una Imagen (PIP), consulte la página 20.

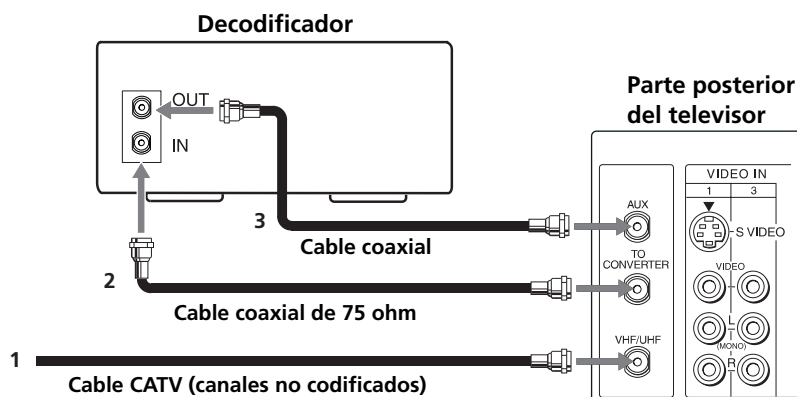

- 1** Conecte el cable coaxial del servicio de cables a la toma VHF/UHF del televisor.
- 2** Conecte la toma IN (entrada) del decodificador a la toma TO CONVERTER (al convertidor) del televisor mediante un cable coaxial (no incluido).
- 3** Conecte la toma OUT (salida) del decodificador a la toma AUX (auxiliar) del televisor mediante un cable coaxial (no incluido).

Presione el botón ANT del control remoto para alternar las entradas de decodificador y de cable directo.

Su control remoto Sony puede programarse para que opere el decodificador (consulte la página 34).

Si desea utilizar el decodificador para cambiar de canal, ponga el televisor en el canal 3 o 4. Ajuste la función Fijar Canal para asegurarse de que no cambia accidentalmente los canales por medio del televisor (consulte la página 27).



## Conexión de equipo adicional

### Conexión de un televisor y una videgrabadora

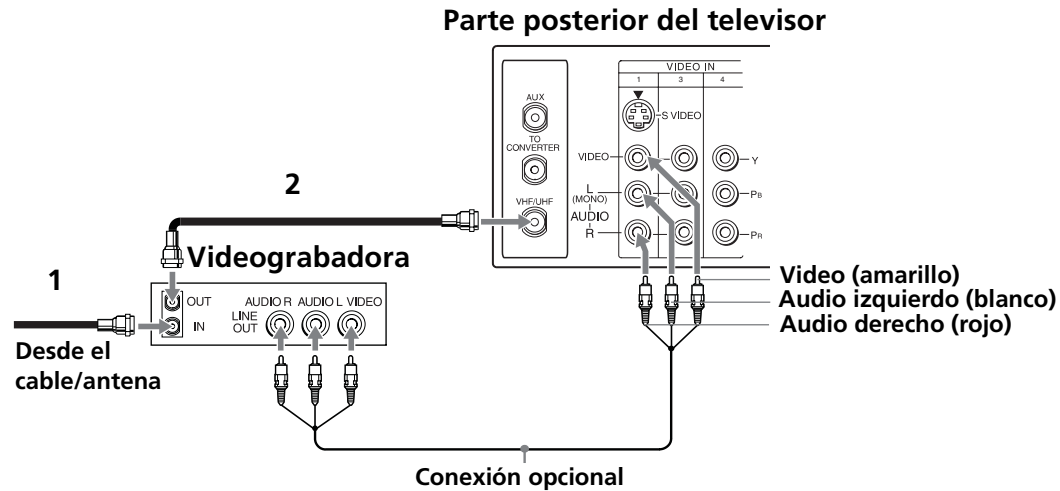

Para ver programas de video desde la videgrabadora, sintonice el televisor en los canales 3 ó 4 (como se indica en la parte posterior de la videgrabadora).

- 1 Conecte el cable coaxial de la antena del televisor o del servicio de cable a la toma IN (entrada) de la videgrabadora.
- 2 Conecte el cable coaxial (no incluido) de la toma OUT (salida) de la videgrabadora a la toma VHF/UHF del televisor.

#### Conexión opcional

Si la videgrabadora dispone de salidas de video, puede obtener una mejor calidad de imagen conectando los cables de audio/video (no incluidos) desde la toma AUDIO/VIDEO OUT (salida de audio/video) de la videgrabadora a la toma AUDIO/VIDEO IN (entrada de audio/video) del televisor.

Se puede utilizar el botón para cambiar entre las entradas VHF/UHF y VIDEO.

Para obtener una mejor calidad de imagen, utilice S VIDEO en lugar del cable amarillo de video. Como S VIDEO no proporciona sonido, debe mantener conectados los cables de audio.

### Conexión de un televisor, una videgrabadora y un decodificador

Utilice esta conexión si está suscrito a un sistema de cable que codifique algunos canales (canales de pago) pero no todos. Esta configuración le permite utilizar el control remoto para:

- ❑ Cambiar de canal por medio del decodificador o la videgrabadora mientras recibe una señal codificada.
- ❑ Cambiar de canal por medio de su televisor.

Esta conexión también le permite utilizar la función Imagen dentro de una Imagen (PIP) mientras ve canales no codificados que lleguen directamente a su televisor por el cable. Las señales codificadas que lleguen desde el decodificador no pueden verse en Imagen dentro de una Imagen (PIP). Para obtener más información sobre la función Imagen dentro de una Imagen (PIP), consulte la página 20.

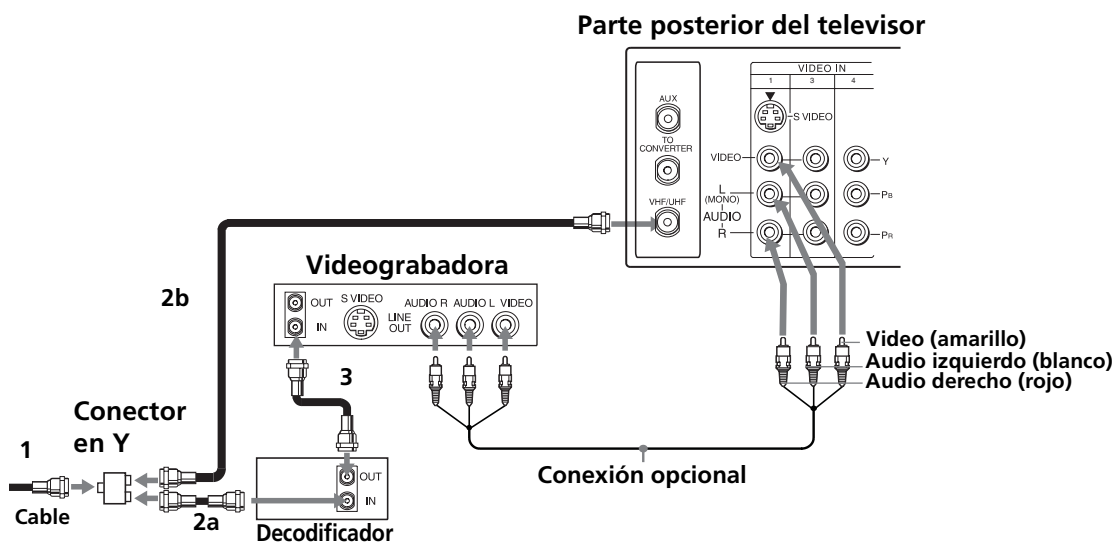

- 1** Conecte la toma unida de entrada del conector en Y a su conexión de cable de entrada.
- 2** Con un cable coaxial (no incluido), conecte las dos tomas de salida del conector en Y a:
  - a)** La toma IN (entrada) del decodificador y
  - b)** La toma VHF/UHF del televisor.
- 3** Conecte la toma OUT (salida) del decodificador a la toma IN (entrada) de la videgrabadora con un cable coaxial (no incluido).

Si desea controlar toda la selección de canales a través del decodificador, es aconsejable utilizar la función Fijar Canal ajustando el televisor en el canal 3 o 4 (consulte la página 27).

Puede utilizar el botón para cambiar entre las entradas VHF/UHF y VIDEO.

### Conexión opcional

Si la videograbadora tiene salidas de video, podrá obtener una mejor calidad de imagen si conecta los cables de audio/video (no incluidos) desde la toma AUDIO/VIDEO OUT (salida de audio/video) de la videograbadora a la toma de entrada AUDIO/VIDEO IN (entrada de audio/video) del televisor.

 Para obtener una mejor calidad de imagen, utilice S VIDEO en lugar del cable amarillo de video. Como S VIDEO no proporciona sonido, debe mantener conectados los cables de audio.

### Conexión de un televisor y un receptor de satélite

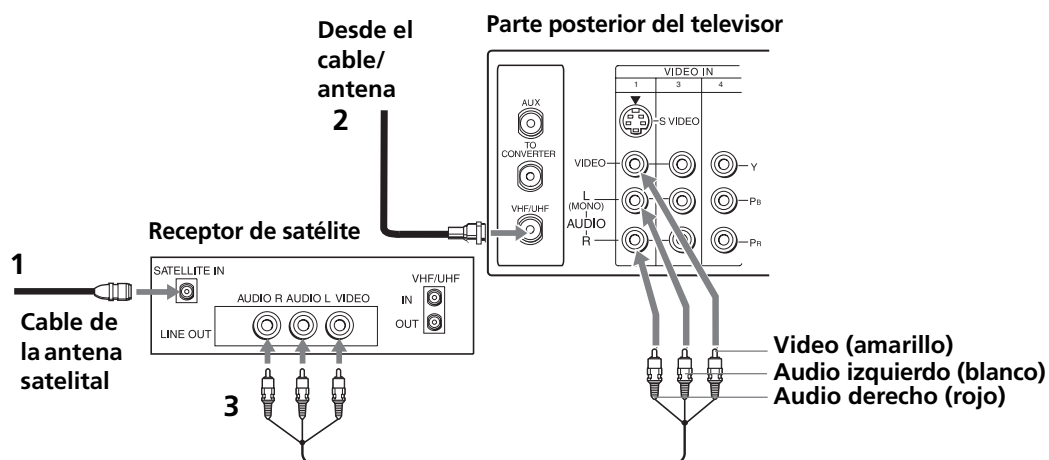

- 1 Conecte el cable de la antena por satélite a la toma SATELLITE IN (entrada de satélite) del receptor de satélite.
- 2 Conecte el cable coaxial del servicio de cable o antena a la toma VHF/UHF del televisor.
- 3 Use cables de audio/video (no incluidos) para conectar las tomas AUDIO/VIDEO OUT (salida de audio/video) del receptor de satélite a las de AUDIO/VIDEO IN (entrada de audio/video) del televisor.

 Puede utilizar el botón  $\text{TV} \text{VIDEO}$  para cambiar entre las entradas VHF/UHF y VIDEO.

 Para obtener una mejor calidad de imagen, utilice S VIDEO en lugar del cable amarillo de video. Como S VIDEO no proporciona sonido, debe mantener conectados los cables de audio.

## Conexión de un televisor, un receptor de satélite y una videgrabadora

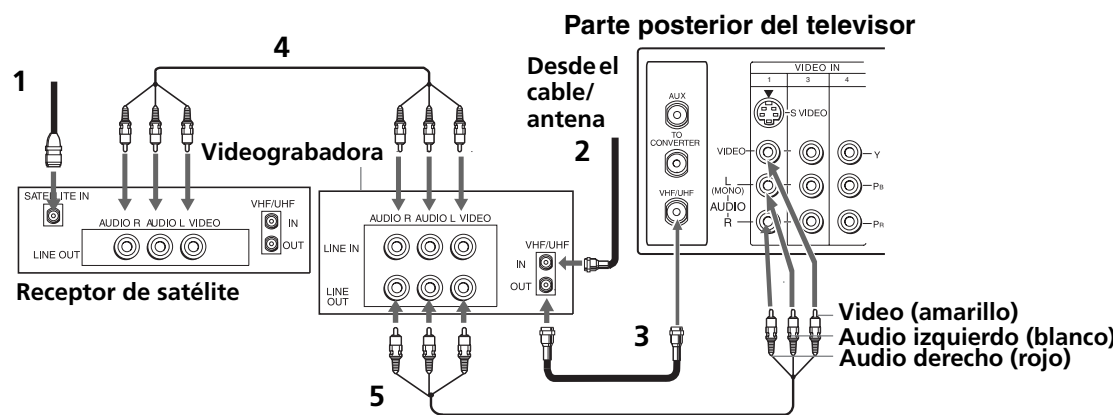

- 1** Conecte el cable de la antena por satélite a la toma SATELLITE IN (entrada de satélite) del receptor de satélite.
- 2** Conecte el cable coaxial del servicio de cables o antena a la toma IN (entrada) de la videgrabadora.
- 3** Conecte la toma OUT (salida) de la videgrabadora a la toma VHF/UHF del televisor con un cable coaxial (no incluido).
- 4** Use cables de audio/video (no incluidos) para conectar las tomas de AUDIO/VIDEO OUT (salida de audio/video) del receptor de satélite a las de AUDIO/VIDEO IN (entrada de audio/video) de la videgrabadora.
- 5** Conecte las tomas AUDIO/VIDEO OUT (salida audio/video) de la videgrabadora a las tomas AUDIO/VIDEO IN (entrada de audio/video) del televisor con cables de audio/video (no incluidos).

 Para ver las imágenes desde el receptor del satélite o la videgrabadora, seleccione la entrada de video a la que esté conectado el receptor de satélite o la videgrabadora presionando **TV/VIDEO** en el control remoto.

## Conexión de un reproductor de DVD

Use cables de audio/video (no incluidos) para conectar las tomas de AUDIO/VIDEO OUT (salida de audio/video) del reproductor de DVD a las de VIDEO IN (entrada de video) del televisor.

### Parte posterior del reproductor de DVD

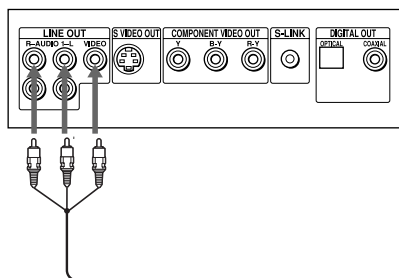

### Parte posterior del televisor

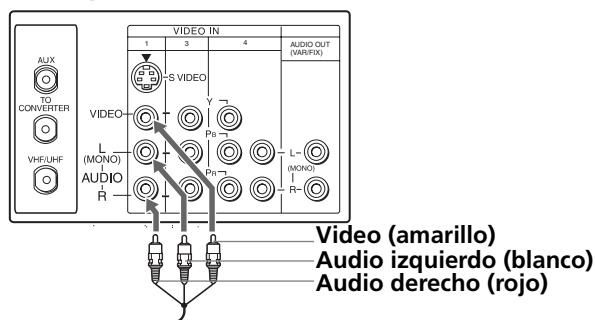

Para obtener una mejor calidad de imagen, utilice S VIDEO en lugar del cable amarillo de video. Como S VIDEO no proporciona sonido, debe mantener conectados los cables de audio.

### Conexión opcional

Si el reproductor de DVD tiene salidas de video para componentes (Y, P<sub>B</sub>, P<sub>R</sub>), puede optimizar la calidad de imagen con cables de video para componentes (480i únicamente).

### Parte posterior del reproductor de DVD

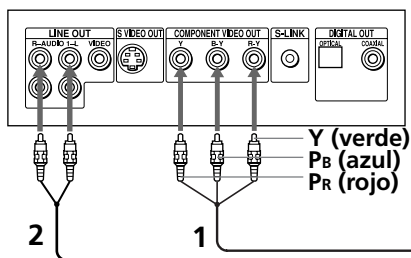

### Parte posterior del televisor

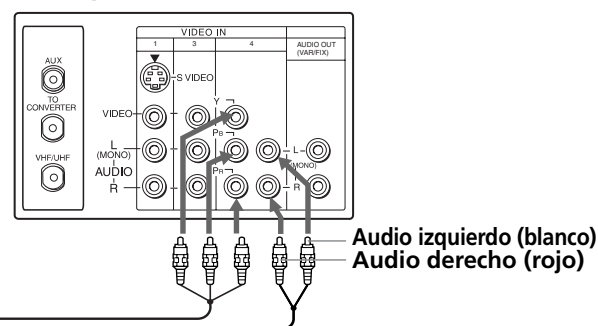

- 1 Conecte Y, P<sub>B</sub>, P<sub>R</sub> OUT de su reproductor de DVD a Y, P<sub>B</sub>, P<sub>R</sub> IN del televisor con cables de componentes de video (no incluidos).
- 2 Conecte la toma AUDIO OUT (salida de audio) del reproductor de DVD a la toma AUDIO IN (entrada de audio) del televisor.

Las salidas Y, P<sub>B</sub>, P<sub>R</sub> del reproductor de DVD en ocasiones están marcadas Y, C<sub>B</sub> y C<sub>R</sub> o Y, B-Y, y R-Y. En tal caso, conecte los cables según el color de las tomas.

### Conexión de una cámara de video

Conecte las tomas AUDIO/VIDEO OUT (salida de audio/video) de la cámara de video a las de AUDIO/VIDEO IN (entrada de audio/video) del televisor con cables de audio/video (no incluidos).

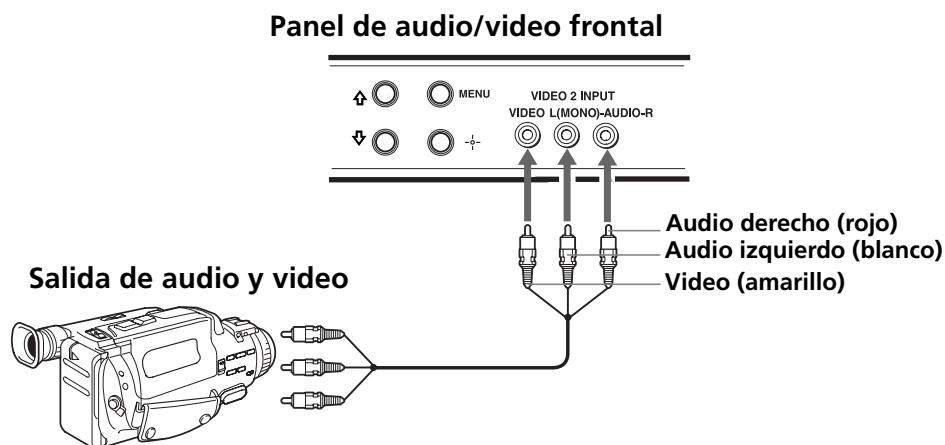

### Conexión de un sistema de sonido

Conecte AUDIO OUT (salida de audio) del televisor a una de las entradas de línea disponibles (por ejemplo TV, AUX, TAPE2) del equipo de sonido con cables de audio (no incluidos).

#### Parte posterior del televisor

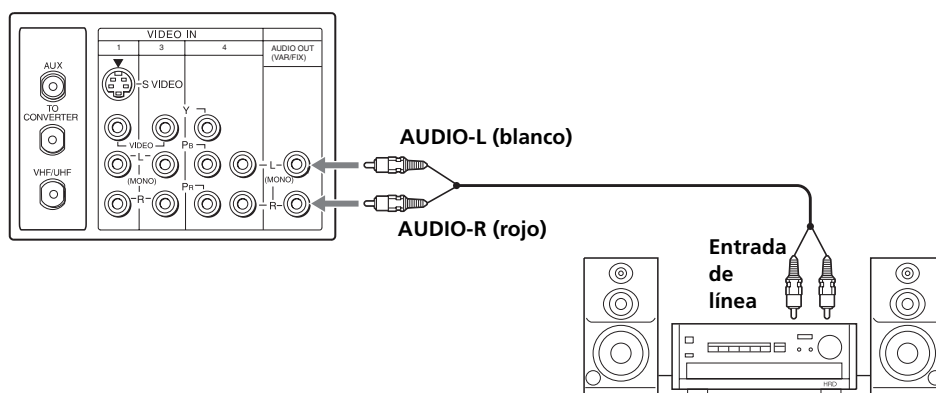

Ajuste el equipo de sonido a la entrada de línea seleccionada. Consulte "Uso del Menú Audio" en la página 25 para obtener más instrucciones sobre la configuración del audio.



# Uso de las funciones básicas

## Ajuste automático del televisor

Cuando haya terminado de conectar el televisor, puede ajustar los canales con la opción de Autoprogramación.



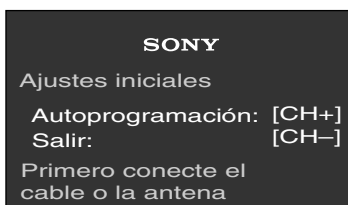







- 1 Presione  para encender el televisor. Aparece la pantalla de Ajustes iniciales.





- 2 Presione  en el control remoto o en el panel frontal del televisor para realizar la función de Autoprogramación, o presione  para salir.

 La pantalla Ajustes iniciales aparecerá cada vez que encienda el televisor hasta que active Autoprogramación.

### Para volver activar Autoprogramación

- 1 Presione .
- 2 Presione  para seleccionar Canal.
- 3 Presione  para seleccionar Cable. Presione  para seleccionar.
- 4 Presione  o  para seleccionar Si o No según el estado del televisor. Presione .
- 5 Presione  para seleccionar Autoprogramación. Presione  para buscar los canales.
- 6 Una vez finalizada la función de Autoprogramación, presione  para salir.

### Para restablecer los ajustes de fábrica

- 1 Encienda el televisor.
- 2 Mantenga oprimido el botón  del control remoto.
- 3 Oprima y suelte el botón POWER (encendido/apagado) del panel frontal del televisor. (El televisor se apagará).
- 4 Suelte el botón .
- 5 Encienda el televisor.



## Acceso rápido a los menús

Los ajustes siguientes están disponibles en los menús de pantalla. Para obtener más detalles sobre el uso de los menús, consulte "Uso de los menús" en la página 23.

Menú	Permite
 <p>Mover:  Seleccionar:  Salir: </p>	Modificar los ajustes de la imagen.
 <p>Mover:  Seleccionar:  Salir: </p>	Cambiar el ajuste de audio.
 <p>Mover:  Seleccionar:  Salir: </p>	Personalizar el ajuste de los canales.
 <p>Mover:  Seleccionar:  Salir: </p>	Bloquear los canales no deseados.

Menú	Permite
	<p>Ajustar el reloj del televisor y programar el encendido y apagado automático en un canal establecido mediante Timer 1 y Timer 2 (Reloj 1 y Reloj 2).</p>
	<p>Seleccionar los modos de subtítulos, etiquetar las entradas de video, corregir la inclinación de la imagen, seleccionar el idioma de los menús, realzar la resolución de la imagen para el reproductor de DVD o ejecutar una demostración de los menús.</p>
	<p>Obtener acceso rápido a los ajustes de menú de uso más común.</p>
	<p>Obtener acceso rápido a los ajustes de menú de uso más común.</p>

## Uso de Imagen dentro de una Imagen (PIP)

La función de Imagen dentro de una Imagen (PIP) le permite ver dos canales al mismo tiempo, uno en tamaño completo en la pantalla del televisor, y otro en una ventanilla dentro de la pantalla del televisor.

 El uso de Imagen dentro de una Imagen (PIP) es solo para los modelos KV-38FS200.

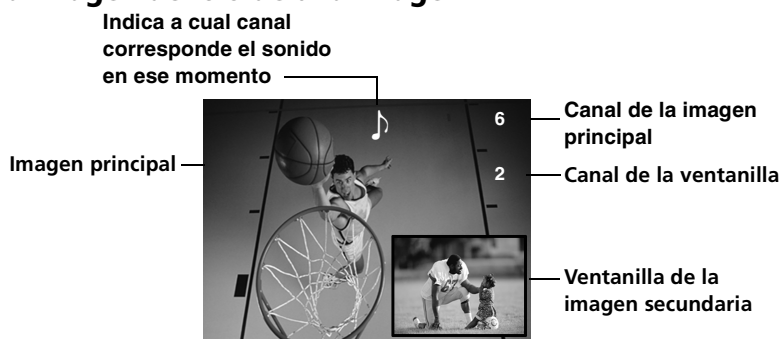

### Para ver una Imagen dentro de una Imagen



### Para usar Imagen dentro de una Imagen (PIP)

- 1 Presione el botón TV de la barra de FUNCTION (función) del control remoto, para utilizar Imagen dentro de una Imagen (PIP) con los botones amarillos. Sintonice su televisor en un canal que se esté emitiendo.
- 2 Presione el botón  y aparecerá la ventanilla.
- 3 Use los botones PIP (amarillos) CH (canal) +/- para cambiar el canal de la ventanilla.









### Para verificar Imagen dentro de una Imagen (PIP)

- 1 Presione el botón TV de la barra de FUNCTION (función) del control remoto, para utilizar Imagen dentro de una Imagen (PIP) con los botones amarillos. Sintonice su televisor en un canal que se esté emitiendo.
- 2 Presione el botón  para activar Imagen dentro de una Imagen (PIP). Presione el botón  para intercambiar la imagen principal con la de la ventanilla.
- 3 Seleccione el mismo canal que el de la ventana principal (utilice los botones principales CH (canal) +/- de la parte inferior de su control remoto). Usted debe tener ahora el mismo programa en la pantalla principal y en la ventanilla.
- 4 Utilice los botones amarillos CH (canal) +/- de la función Imagen dentro de una Imagen (PIP), para cambiar el canal de la ventanilla.
- 5 Presione el botón amarillo  de Imagen dentro de una Imagen (PIP), para cambiar a otras entradas de video de otros aparatos que estén conectados a cualquiera de las tomas VIDEO IN (entrada de video) de la parte posterior y frontal de su televisor.

- 6** Si la función Imagen dentro de una Imagen (PIP) no funciona correctamente con el televisor o el equipo de video conectado a él, consulte la sección de Solución de problemas que comienza en la página 36 para ver posibles soluciones.

 Si tiene problemas con la función Imagen dentro de una Imagen (PIP), consulte la sección "Ajustes que pueden afectar el uso de Imagen dentro de una Imagen (PIP)" (página 22) o consulte la sección de Solución de problemas (página 36) para ver posibles soluciones.

### Función de los botones PIP

Botones de etiqueta amarilla PIP	Descripción
	Presione para activar la función Imagen dentro de una Imagen (PIP). Presione repetidas veces para cambiar el tamaño de la imagen de la ventanilla y desactivar la función Imagen dentro de una Imagen (PIP).
	Presione para recorrer el equipo de video que tiene conectado al televisor (en la ventanilla).
	Presiónelo para alternar entre el sonido de la imagen principal y el de la ventanilla. El símbolo de sonido  aparece durante tres segundos, indicándole si el sonido que escucha proviene de la imagen principal o de la ventanilla.
	Presiónelo para cambiar el canal de la ventanilla. Para cambiar el canal de la imagen principal, use los botones principales CH (canal) +/- en la parte inferior del control remoto.
	Presione para cambiar la ubicación de la ventanilla a cualquiera de las cuatro esquinas de la pantalla.
	Presione para congelar la imagen de la ventanilla. Presione el botón de nuevo para restaurar la imagen. La imagen principal sigue funcionando normalmente.
	Presione para intercambiar la imagen principal con la de la ventanilla. Presione este botón de nuevo para regresar al estado original.

 Para obtener más información sobre su control remoto, consulte "Uso del control remoto" en la página 3.

#### Para cambiar de canal en la ventanilla

- Utilice los botones amarillos CH (canal) +/- de Imagen dentro de una Imagen (PIP), para navegar a través de los canales del televisor.
- Utilice el botón amarillo TV/VIDEO para cambiar a otras entradas de video de otros aparatos que estén conectados a su televisor como su grabadora, reproductor de DVD o receptor de satélite.

## Ajustes que pueden afectar el uso de Imagen dentro de una Imagen (PIP)

 El uso de Imagen dentro de una Imagen (PIP) es solo para los modelos KV-38FS200.

- ❑ No podrá verse en la ventanilla PIP ningún equipo de video que tenga usted conectado a la entrada AUX (auxiliar).
- ❑ PIP no funcionará si está usted viendo todos los canales a través de un decodificador. Este dispositivo decodifica una sola señal a la vez, por lo que la imagen en la ventanilla será idéntica a la de la imagen principal.
- ❑ Se puede usar Imagen dentro de una Imagen (PIP) para ver en su televisor imágenes provenientes de diversas fuentes. Por ejemplo, mediante esta función, se puede ver simultáneamente en la pantalla un canal normal de cable y la imagen generada por una videograbadora, un reproductor de DVD o un receptor satelital. Para lograrlo:
  - 1** Conecte el cable del servicio de televisión por cable en la entrada VHF/UHF en la parte posterior del televisor.
  - 2** Conecte el otro aparato (videograbadora, reproductor de DVD o receptor satelital) en cualquiera de las tomas VIDEO IN (entrada de video) en la parte posterior y frontal del televisor.
  - 3** Sintone un canal en la imagen principal.
  - 4** Sintone un segundo canal en la ventanilla.









Puede entonces intercambiar las dos imágenes que están en la pantalla del televisor.



 No se puede usar una señal mediante la entrada AUX (auxiliar) con Imagen dentro de una Imagen.

# Uso de los menús

Esta sección muestra las opciones disponibles para configurar y ajustar el televisor.

## Para acceder a un menú

- 1** Presione  para ver el menú en pantalla.
- 2** Utilice los botones  o  para seleccionar el menú deseado y después presione .
- 3** Utilice los botones  o  para seleccionar la opción deseada y después presione .
- 4** Siga las indicaciones que aparecen en pantalla para activar las opciones deseadas. Presione  para terminar el ajuste.
- 5** Presione  para salir del menú.

 Presione  una vez para mostrar el menú en pantalla y presiónelo de nuevo para volver a la vista normal. Si no presiona ningún botón, el menú se cierra automáticamente transcurridos 90 segundos aproximadamente.

## Uso del Menú Video



Para acceder al menú Video, siga los siguientes pasos:

**Para mostrar**



**Para seleccionar**





Presione  para resaltar la opción deseada y después presione .



### Modo

Visualización personalizada de la imagen



Presione  o  para resaltar una de las siguientes opciones y después presione  para seleccionarla.

**Vívido:** Seleccione este modo para aumentar el contraste y la nitidez de la imagen.



**Estándar:** Seleccione este modo para obtener una imagen estándar.



**Película:** Seleccione este modo para obtener una imagen muy detallada.



**Deportes:** Seleccione este modo para obtener una imagen brillante.



 Presione  para acceder directamente a los ajustes de Modo (Vívido, Estándar, Película y Deportes).



### Controles de imagen

**Contraste:** Presione  para reducir el contraste de la imagen. Presione  para aumentar el contraste de la imagen.

**Brillo:** Presione  para oscurecer la imagen. Presione  para aumentar el brillo de la imagen.



**Color:** Presione  para reducir la intensidad del color. Presione  para aumentar la intensidad del color.

**Tinte:** Presione  para aumentar los tonos rojos. Presione  para aumentar los tonos verdes.

**Nitidez:** Presione  para suavizar la imagen. Presione  para aumentar la nitidez de la imagen.

### Temp. Color

Ajuste de la tonalidad del blanco

Presione  o  para resaltar una de las siguientes opciones y después presione  para seleccionarla.



**Frío:** Proporciona a los colores blancos un tono azulado.

**Neutro:** Proporciona a los colores blancos un tono neutro.

**Cálido:** Proporciona a los colores blancos un tono rojizo.

### VM

Modulación de velocidad

Aumenta la nitidez de la imagen y proporciona un contorno limpio y nítido a los objetos. Utilice los botones  o  para seleccionar una de las siguientes opciones: **Alto**, **Bajo**, **No**. Después oprima .

## Uso del Menú Audio

Para acceder al menú Audio, siga los siguientes pasos:

**Para mostrar**



**Para resaltar**

















**Para seleccionar**







Presione  para resaltar la opción deseada y después presione .



<b>Agudos</b>	Presione  para reducir los sonidos agudos. Presione  para aumentar los sonidos agudos.
<b>Graves</b>	Presione  para reducir los sonidos graves. Presione  para aumentar los sonidos graves.
<b>Balance</b>	Presione  para enfatizar el volumen de la bocina izquierda. Presione  para enfatizar el volumen de la bocina derecha.
<b>Auto Volumen</b> <i>Estabiliza el volumen</i>	Presione  o  para resaltar una de las siguientes opciones y después presione  para seleccionarla. <b>Sí:</b> Seleccione esta opción para estabilizar el volumen cuando cambie de canal. <b>No:</b> Seleccione esta opción para desactivar Auto Volumen.
<b>Efecto</b>	Presione  o  para resaltar una de las siguientes opciones y después presione  para seleccionarla. <b>Surround:</b> Simula el sonido con calidad de sala de cine para programas estéreo. <b>No:</b> Recepción mono o estéreo normal.

 Presione  para acceder directamente a los ajustes de Efecto de Audio (Surround, No).







<b>MTS</b> <i>Sonido Multicanal del Televisor</i>	Presione  o  para resaltar una de las siguientes opciones y después presione  para seleccionarla. <b>Estéreo:</b> Seleccione esta opción cuando vea una emisión en estéreo. <b>Auto SAP:</b> Seleccione esta opción para que el televisor cambie automáticamente al Segundo Programa de Audio (SAP) al recibir la señal. <b>Mono:</b> Seleccione esta opción para reducir el ruido en zonas de difícil recepción.
--	---

 Presione  para acceder directamente a los ajustes de MTS (Estéreo, Auto SAP y Mono).



## Manual de instrucciones

---

<b>Bocinas</b> <i>Selección personalizada de la fuente de salida de audio</i>	Presione  o  para resaltar una de las siguientes opciones y después presione  para seleccionarla. <b>Sí:</b> Seleccione esta opción para escuchar el sonido de las bocinas del televisor con sistema estéreo adicional o sin él. <b>No:</b> Seleccione esta opción para apagar las bocinas del televisor y escuchar el sonido del televisor únicamente por las bocinas del sistema de audio externo.
<b>Salida de Audio</b> <i>Utilícelo para controlar el volumen del televisor con un equipo de sonido</i>	Presione  o  para resaltar una de las siguientes opciones y después presione  para seleccionarla. <b>Variable:</b> Ajusta el volumen a través del televisor. <b>Fija:</b> Ajusta el volumen a través de un dispositivo estéreo conectado.

 La función Salida de Audio sólo puede activarse cuando Bocinas se encuentra en la posición No.

 Si el televisor se encuentra en el modo Auto SAP, es posible que algunos programas se silencien o se distorsionen. Si el televisor no emite ningún sonido, cambie el ajuste de Audio a Estéreo o Mono.

## Uso del Menú Canal

Para acceder al menú Canal, siga los siguientes pasos:

**Para mostrar**



**Para resaltar**















**Para seleccionar**







Presione  para resaltar la opción deseada y después presione .





- |  |   |
|--|---|
| <p><b>Canales Favoritos</b><br/><i>Acceso rápido a los canales favoritos</i></p> | <ol style="list-style-type: none"> <li>1 Presione  o  para seleccionar la posición (1 a 8) en la que desea ajustar un canal favorito y después presione .</li> <li>2 Presione  o  para desplazarse por los canales hasta encontrar el que desea agregar a sus canales favoritos.</li> <li>3 Presione  para seleccionarlo, esto cambiará su televisor de manera automática al canal que seleccionó.</li> <li>4 Presione  para volver al menú de Canal o presione  para salir.</li> </ol> |
|--|---|

 Para usar la opción de Canales Favoritos: Salga de todos los menús y presione . Presione  o  para desplazar el cursor al número de canal deseado y presione .

- |                     |   |
|---------------------|---|
| <p><b>Cable</b></p> | <p>Presione  o  para resaltar una de las siguientes opciones y después presione  para seleccionarla.</p> <p><b>Sí:</b> Selecciónelo si recibe canales vía cable.</p> <p><b>No:</b> Selecciónelo si utiliza una antena de televisión.</p> |
|---------------------|---|

 Después de cambiar los ajustes del cable, deberá realizar la función Autoprogramación.

- |                           |  |
|---------------------------|--|
| <p><b>Fijar Canal</b></p> | <p>Presione  o  para resaltar una de las siguientes opciones y después presione  para seleccionarla.</p> <p><b>No:</b> Fijar Canal no está activado.</p> <p><b>2-6:</b> Selecciónelos cuando desee controlar toda la selección de canales por medio de un decodificador o una videograbadora. Seleccione el canal adecuado (normalmente el 3 o el 4) y utilice el control remoto del decodificador o de la videograbadora para seleccionar los canales.</p> <p><b>AUX 2-6:</b> Utilice este ajuste en lugar de <b>2-6</b> si desea cambiar de canal mediante un decodificador, videograbadora o receptor de satélite y lo haya conectado a la entrada AUX (sólo en los modelos KV-38FS200).</p> <p><b>Video 1:</b> Seleccione esta opción desde las entradas de video disponibles cuando haya conectado el equipo de video (por ejemplo, el receptor de satélite) y desee que quede fijo en el televisor.</p> |
|---------------------------|--|

## Manual de instrucciones

**Autoprogramación** Realice la función Autoprogramación siempre que ajuste el televisor. El televisor recorrerá todos los canales disponibles y programará los que se reciben.

**Omitir/Añadir Canal** Utilice esta función después de ejecutar Autoprogramación para omitir los canales no deseados o para añadir nuevos canales.

- 1 Presione  $\uparrow$  o  $\downarrow$  para seleccionar la posición del canal deseado y después presione  $\rightarrow$ .
- 2 Presione  $\uparrow$  o  $\downarrow$  para omitir o añadir canal y después presione  $\rightarrow$ .
- 3 Presione  $\leftarrow$  para volver al menú de Canal o presione  $\text{MENU}$  para salir.

 Cuando presione CH (canal) + o CH (canal) - no tendrá acceso a los canales omitidos, sólo a través de los botones  $\text{0-9}$  podrá sintonizarlos.

**Nombre del Canal** 1 Presione  $\rightarrow$  y después presione  $\uparrow$  o  $\downarrow$  hasta que localice el número de canal deseado. Presione  $\rightarrow$  para activar el canal.

*Etiqueta hasta 40 canales con sus letras de llamada*

- 2 Presione  $\downarrow$  para resaltar "Nombre" y después presione  $\rightarrow$ . Presione  $\uparrow$  o  $\downarrow$  para mostrar la primera letra de llamada o número de captura y después presione  $\rightarrow$  para seleccionarlo. Repita este proceso, hasta que halla seleccionado todas las letras.

- 3 Presione  $\leftarrow$  para volver al menú de Canal o presione  $\text{MENU}$  para salir.

 No podrá utilizar las opciones Canales Favoritos, Cable, Omitir/Añadir Canal, Nombre del Canal y el menú de Bloqueo de Canal cuando Fijar Canal esté activado.

## Uso del Menú Bloqueo de Canal

Para acceder al menú Bloqueo de Canal, siga los siguientes pasos:



**Para mostrar** **Para resaltar** **Para seleccionar**







MENU → [Bloqueo] → [Bloqueo]

**Bloqueo de Canal**

1: No	No
2: No	1
3: No	2
4: No	3
	4
	↓

Acceso paterno a los canales

Mover: [Left] [Right] [Up] [Down]    Seleccionar: [Enter]    Salir: [MENU]

- Bloquear o Desbloquear**
- 1 Presione  o  para seleccionar la posición (1 a 4) en la que desee bloquear o desbloquear un canal y después presione .
  - 2 Presione  o  para desplazarse por los canales hasta encontrar el canal que desee bloquear o desbloquear y después presione .
  - 3 Presione  para salir.





 Si un canal está bloqueado, se mostrará una pantalla negra con la palabra "Bloqueado", (solamente para el uso habitual del televisor).

## Uso del Menú Timer (Reloj)







Para acceder al menú Timer, siga los siguientes pasos:

**Para mostrar** **Para resaltar** **Para seleccionar**





- Hora Actual** Permite ajustar el día y la hora actual en su televisor. Presione  para abrir el menú de Hora Actual:
- 1 Presione  o  para resaltar el día que desee introducir y después presione , repita este proceso hasta que halla seleccionado la hora completa.
  - 2 Presione  para salir del menú.

 Debe ajustar la Hora Actual antes de poder utilizar Timer 1 y Timer 2 (Reloj 1 y Reloj 2).

- Timer 1 y Timer 2 (Reloj 1 y Reloj 2)** Programa su televisor al día, hora, duración y canal deseado. La programación máxima del reloj es de 6 horas. Cuando el canal esté fijado, no será necesario introducirlo.
- Visualización programada*
- 1 Presione  o  para seleccionar Timer 1 o Timer 2 (Reloj 1 o Reloj 2) y después presione .
  - 2 Presione  o  para introducir el día, hora, duración y el canal deseado y después presione . Timer (Reloj) debe estar en Sí cuando se haya fijado, y se encenderá una luz roja en el panel frontal del televisor.
  - 3 Presione  para salir del menú.

 Puede fijar Timer (Reloj) en las posiciones Sí, No o Programar. Cuando Timer 1 y Timer 2 (Reloj 1 y Reloj 2) estén ajustados podrá activarlos y desactivarlos sin tener que revisar los ajustes.

 Al ejecutar Autoprogramación, los ajustes de Timer 1 y Timer 2 (Reloj 1 y Reloj 2) se borrarán. Asimismo, en caso de producirse una pérdida de electricidad, los ajustes de Hora Actual, Timer 1 y Timer 2 (Reloj 1 y Reloj 2) se borrarán.

## Uso del Menú Ajustes

Para acceder al menú Ajustes, siga los siguientes pasos:



Presione para resaltar la opción deseada y después presione .



<b>Caption Vision</b> <i>Subtítulos</i>	<p>Permite seleccionar tres modos de subtítulos (para programas que se emiten con subtítulos).</p> <p>Presione  o  para resaltar una de las siguientes opciones y después presione  para seleccionarla.</p> <p><b>No:</b> Los subtítulos no están activados.</p> <p><b>CC1, 2, 3, 4:</b> Muestra el diálogo impreso y los efectos de sonido de un programa.</p> <p><b>Text1, 2, 3, 4:</b> Muestra información sobre la red o emisora.</p> <p><b>Info:</b> Muestra el nombre del programa actual y el tiempo restante, si está disponible.</p>
--	---

<b>Etiqueta de Video</b> <i>Etiqueta el equipo conectado</i>	<p>Permite etiquetar los componentes de audio/video que tiene conectado a su televisor: videgrabadora, reproductor de DVD, etc. Cuando presione TV/VIDEO para cambiar las entradas de video, la etiqueta de video se mostrará en la pantalla.</p> <ol style="list-style-type: none"> <li>Presione  o  para seleccionar la entrada que desee etiquetar y después presione .</li> <li>Presione  o  para elegir una etiqueta y presione .</li> <li>Presione  para volver al menú de Ajustes o presione  para salir.</li> </ol>
---	---

Si usted selecciona "Omitir", su televisor pasará por alto esta conexión al oprimirse el botón TV/VIDEO.

<b>Rotación</b>	<p>Presione  o  para corregir la inclinación de la imagen entre -5 a +5 y después presione  para activarla.</p>
-----------------	---

<b>Idioma</b>	<p>Muestra todos los menús en el idioma elegido.</p> <p>Presione  o  para seleccionar el idioma deseado: English (Inglés), Español, Français (Francés) y después presione .</p>
---------------	---

<b>Modo 16:9</b>	<p>Proporciona una resolución mejorada de la imagen para fuentes de pantalla panorámica como el reproductor de DVD (sólo está disponible cuando el televisor esté en modo Video).</p>
------------------	---

<b>Demo</b> <i>Demostración</i>	<p>Presione  para efectuar una demostración de los menús en pantalla.</p>
------------------------------------	---

Puede presionar cualquier tecla para salir del modo Demo (Demostración).







## Uso del Menú Básico





Para acceder al menú Básico, siga los siguientes pasos:

<p><b>Para mostrar</b></p> 	→	<p><b>Para resaltar</b> </p> 	→	<p><b>Para seleccionar</b></p> 	
--	---	---	---	--	--

Presione  para resaltar la opción deseada y después presione .

**Mover:**     **Seleccionar:**  **Salir:** 







<b>Contraste</b>	Presione  para disminuir el contraste de la imagen.
<i>Contraste de la imagen</i>	Presione  para aumentar el contraste de la imagen.
<b>Caption Vision</b>	En el menú Básico, Caption Vision solo muestra No y la última opción seleccionada (CC1-4, Text1-4, o Info).
<i>Subtítulos</i>	
<b>Efecto</b>	Presione  o  para resaltar una de las siguientes opciones y después presione  para seleccionarla.
<b>Surround:</b>	Simula el sonido con calidad de sala de cine para programas estéreo.
<b>No:</b>	Recepción mono o estéreo normal.
<b>Menú Avanzado</b>	Presione  para volver a los menús avanzados.

 Si utiliza el botón  para cerrar el menú Básico, éste aparecerá de nuevo cuando vuelva a presionar . Para acceder a los demás menús, presione  para resaltar el Menú Avanzado y después presione .

# Información adicional

## Programación del control remoto

Puede utilizar el control remoto incluido con equipos de video Sony y de otros proveedores.

- 1 Presione .
- 2 Presione  o  de la barra FUNCTION (función).
- 3 Utilice los botones - para introducir el número de código según la siguiente tabla.
- 4 Presione .

### Códigos de videograbadora

Sony	301, 302, 303	JCPenney	309, 305, 304, 330, 314, 336, 337
Admiral (M.Ward)	327	JVC	314, 336, 337, 345, 346, 347
Aiwa	338, 344	Kenwood	314, 336, 332, 337
Audio Dynamic	314, 337	LXI (Sears)	332, 305, 330, 335, 338
Broksonic	319, 317	Magnavox	308, 309, 310
Canon	309, 308	Marantz	314, 336, 337
Citizen	332	Marta	332
Craig	302, 332	Memorex	309, 335
Criterion	315	Minolta	305, 304
Curtis Mathis	304, 338, 309	Mitsubishi/MGA	323, 324, 325, 326
Daewoo	341, 312, 309	Multitech	325, 338, 321
DBX	314, 336, 337	NEC	314, 336, 337
Dimensia	304	Olympic	309, 308
Emerson	319, 320, 316, 317, 318, 341	Optimus	327
Fisher	330, 335	Panasonic	308, 309, 306, 307
Funai	338	Pentax	305, 304
General Electric	329, 304, 309	Philco	308, 309
Go Video	322, 339, 340	Philips	308, 309, 310
Goldstar	332	Pioneer	308
Hitachi	306, 304, 305, 338	Quasar	308, 309, 306
Instant Replay	309, 308	RCA/PROSCAN	304, 305, 308, 309, 311, 312, 313, 310, 329
Realistic	309, 330, 328, 335, 324, 338	Symphonic	338
Samsung	322, 313, 321	Tashiro	332
Sansui	314	Tatung	314, 336, 337
Sanyo	330, 335	Teac	314, 336, 338, 337



## Manual de instrucciones

### Códigos de videograbadora

Scott	312, 313, 321, 335, 323, 324, 325, 326	Technics	309, 308
Sharp	327, 328	Toshiba	312, 311
Shintom	315	Wards	327, 328, 335, 331, 332
Signature 2000 (M.Ward)	338, 327	Yamaha	314, 330, 336, 337
SV2000	338	Zenith	331
Sylvania	308, 309, 338, 310		

### Códigos de decodificadores de cable

Sony	230
Hamlin/Regal	222, 223, 224, 225, 226
Jerrold/G. I.	201, 202, 203, 204, 205, 206, 207, 208, 218
Oak	227, 228, 229
Panasonic	219, 220, 221
Pioneer	214, 215
Scientific Atlanta	209, 210, 211
Tocom	216, 217
Zenith	212, 213

### Códigos de reproductores de discos láser

Sony	701
Panasonic	704, 710
Pioneer	702

### Códigos de DBS

DIRECTV	809
Red Echostar/Dish	810

### Códigos de receptor de satélite

Sony	801
General Electric	802
Hitachi	805
Hughes	804
Panasonic	803
RCA/PROSCAN	802, 808
Toshiba	806, 807

### Códigos de reproductores de DVD









Sony	751
JVC	756
Mitsubishi	761
Onkyo	762
Oritron	759
Panasonic	753
Philips/ Magnavox	757
Pioneer	752
RCA	755
Samsung/Hitachi	758
Toshiba	754
Zenith	760

 Si aparecen varios códigos, introdúzcalos por separado hasta que encuentre el código correcto para su equipo.









 Cuando retire las baterías del control remoto, es posible que los números de los códigos vuelvan a los ajustes de fábrica y sea necesario reconfigurarlos.

 En casos excepcionales, es posible que no pueda utilizar el equipo con el control remoto incluido. En tal caso, utilice el control original de dicho equipo.



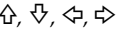

### Uso de una videgrabadora

Presione	Para
	Encender la videgrabadora
	Seleccionar los canales directamente
	Cambiar de canal
	Reproducir cintas de video
	Detener el funcionamiento
	Desplazarse hacia adelante o hacia atrás
	Poner en pausa
 (Simultáneamente)	Grabar
	Alternar entre las entradas TV y VCR

### Uso de un reproductor de DVD

Presione	Para
	Encender el reproductor de DVD
	Seleccionar capítulos directamente
	Buscar capítulos hacia adelante o hacia atrás
	Reproducir un DVD
	Detener el funcionamiento
	Poner en pausa
	Desplazar el cursor por el menú
	Mostrar el menú DVD



### Uso de un reproductor de discos láser

Presione	Para
	Encender el reproductor de discos láser
	Buscar capítulos hacia adelante o hacia atrás
	Reproducir discos
	Detener el funcionamiento
	Poner en pausa

## Solución de problemas

Si tiene problemas con el televisor, intente seguir las indicaciones que se sugieren a continuación. Si el problema persiste, consulte con su proveedor Sony más cercano.

Problema	Posibles Soluciones
<b>Hace falta restablecer los ajustes de fábrica</b>	<ul style="list-style-type: none"> <li><input type="checkbox"/> Encienda el televisor. Mientras mantenga oprimido el botón  del control remoto, oprima el botón de POWER (encendido/apagado) en el televisor. (El televisor se apagará). Suelte el botón , enciéndalo nuevamente.</li> </ul>
<b>No hay imagen ni sonido</b>	<ul style="list-style-type: none"> <li><input type="checkbox"/> Asegúrese de que el cable de alimentación está conectado.</li> <li><input type="checkbox"/> Si hay una luz roja que parpadea en la parte frontal del televisor durante algunos minutos, desconecte y vuelva a conectar el cable de alimentación para restaurar el televisor. Si el problema persiste, llame al servicio técnico local.</li> <li><input type="checkbox"/> Compruebe los ajustes de TV/VIDEO: si ve la televisión, póngalo en TV; si ve imágenes de un aparato de video, póngalo en VIDEO 1, 2, 3 o 4 (página 4).</li> <li><input type="checkbox"/> Asegúrese de que las baterías están introducidas correctamente en el control remoto (página 2).</li> <li><input type="checkbox"/> Intente ver otro canal para descartar algún problema en la emisora.</li> </ul>
<b>Imagen de baja calidad o sin imagen, buen sonido</b>	<ul style="list-style-type: none"> <li><input type="checkbox"/> Ajuste el Contraste en el menú de Video (página 24).</li> <li><input type="checkbox"/> Ajuste el Brillo en el menú de Video (página 24).</li> <li><input type="checkbox"/> Compruebe las conexiones de la antena o del cable (página 7).</li> </ul>
<b>Buena imagen, sin sonido</b>	<ul style="list-style-type: none"> <li><input type="checkbox"/> Presione  para que desaparezca Muting (silenciamiento automático) de la pantalla (página 3).</li> <li><input type="checkbox"/> Compruebe los ajustes de Audio. Es posible que el televisor esté ajustado en Auto SAP o Bocinas se encuentre en la posición No (página 25).</li> <li><input type="checkbox"/> Presione  para subir el volumen de su televisor, es posible que se encuentre demasiado bajo.</li> </ul>
<b>Sin color</b>	<ul style="list-style-type: none"> <li><input type="checkbox"/> Ajuste Color en el menú de Video (página 24).</li> </ul>
<b>Sin señal</b>	<ul style="list-style-type: none"> <li><input type="checkbox"/> Compruebe el ajuste del cable en el menú de Canal (página 27).</li> <li><input type="checkbox"/> Compruebe las conexiones de la antena o del cable (página 7).</li> <li><input type="checkbox"/> Asegúrese de que el canal seleccionado esté emitiendo señal.</li> </ul>
<b>Líneas de puntos o rayas</b>	<ul style="list-style-type: none"> <li><input type="checkbox"/> Ajuste la antena.</li> <li><input type="checkbox"/> Aparte el televisor de cualquier otro equipo electrónico. Algunos equipos electrónicos crean ruido eléctrico que puede interferir con la recepción del televisor.</li> </ul>
<b>Imágenes dobles o fantasmas</b>	<ul style="list-style-type: none"> <li><input type="checkbox"/> Revise la antena exterior o llame al servicio técnico de cable.</li> </ul>
<b>No se reciben canales con un número alto (UHF) cuando se utiliza una antena</b>	<ul style="list-style-type: none"> <li><input type="checkbox"/> Asegúrese de que Cable está en la posición No en el menú de Canal (página 27).</li> <li><input type="checkbox"/> Ejecute Autoprogramación para añadir canales que actualmente no estén en la memoria (página 17).</li> </ul>
<b>Parece que no funcionan las emisoras de cable</b>	<ul style="list-style-type: none"> <li><input type="checkbox"/> Asegúrese de que Cable está en la posición Si en el menú de Canal (página 27).</li> <li><input type="checkbox"/> Ejecute Autoprogramación para añadir canales que actualmente no estén en la memoria (página 17).</li> </ul>

Problema	Posibles Soluciones
<b>El control remoto no funciona</b>	<ul style="list-style-type: none"> <li><input type="checkbox"/> Al operar su televisor, oprima TV de la barra FUNCTION (función).</li> <li><input type="checkbox"/> Vea si colocó las baterías correctamente.</li> <li><input type="checkbox"/> Las baterías pueden estar bajas. Sustitúyalas (página 2).</li> <li><input type="checkbox"/> Aleje el televisor a 1 metro aproximadamente de cualquier lámpara fluorescente.</li> </ul>
<b>No se puede cambiar el canal con el control remoto</b>	<ul style="list-style-type: none"> <li><input type="checkbox"/> Asegúrese de que no ha cambiado el televisor del canal 3 o 4 con otro dispositivo para cambiar canales.</li> <li><input type="checkbox"/> Si está usando otro aparato para cambiar los canales, no olvide presionar el botón FUNCTION (función) correspondiente a ese aparato. Por ejemplo, si está usando su videgrabadora para controlar los canales, asegúrese de presionar los botones VCR/DVD de la barra FUNCTION (función) (página 3).</li> </ul>
<b>No puede acceder a otros menús con el menú Básico.</b>	<ul style="list-style-type: none"> <li><input type="checkbox"/> Si utiliza el botón  para cerrar el menú Básico, éste aparecerá de nuevo cuando vuelva a presionar . Para acceder a los demás menús, seleccione menú Avanzado (página 32).</li> </ul>
<b>El control remoto no funciona en modo PIP</b>	<ul style="list-style-type: none"> <li><input type="checkbox"/> Presione el botón TV de la barra FUNCTION (función). Es posible que accidentalmente haya presionado el botón VCR/DVD de la barra FUNCTION (función), que cambia los botones PIP al modo de videgrabadora (página 21).</li> </ul>
<b>No aparece la ventanilla en pantalla o no tiene imagen</b>	<ul style="list-style-type: none"> <li><input type="checkbox"/> Asegúrese que la ventanilla se encuentre sintonizada con una fuente de video o un canal con programación al aire.</li> <li><input type="checkbox"/> Es posible que se encuentre sintonizado con una entrada de video que no tiene nada conectado. Trate de recorrer sus entradas de video con el botón amarillo con el punto rojo TV/VIDEO (página 21).</li> </ul>
<b>Se ve el mismo programa en la ventanilla que en la pantalla principal</b>	<ul style="list-style-type: none"> <li><input type="checkbox"/> Es posible que ambas se encuentren sintonizadas al mismo canal. Trate de cambiar canales, ya sea en la pantalla principal o en la ventanilla (página 20).</li> <li><input type="checkbox"/> Es posible que su televisor esté configurado para seleccionar todos los canales mediante un decodificador de cable. El decodificador de cable sólo decodificará una señal a la vez, por lo que usted no podrá utilizar la función PIP. Si es posible, conecte un cable directo a la toma VHF/UHF de su televisor. Esto sólo funcionará si su sistema de cable proporciona una señal no codificada (página 9).</li> </ul>
<b>Sólo puedo sintonizar señal de televisión en la ventanilla</b>	<ul style="list-style-type: none"> <li><input type="checkbox"/> Asegúrese de que no configuró la etiqueta de video en el menú de Ajustes (página 31) para omitir sus entradas de video.</li> </ul>
<b>El televisor está sucio</b>	<ul style="list-style-type: none"> <li><input type="checkbox"/> Limpie el televisor con un paño suave y seco. Nunca use solventes fuertes como diluyentes o bencina, puesto que pueden dañar el acabado de la unidad.</li> </ul>
<b>Perdió el control remoto</b>	<ul style="list-style-type: none"> <li><input type="checkbox"/> Puede utilizar los controles del panel frontal de audio y video para acceder a los menús (página 2). Póngase en contacto con su proveedor Sony más cercano para solicitar uno de repuesto.</li> </ul>
<b>Aparece un cuadro negro en la pantalla</b>	<ul style="list-style-type: none"> <li><input type="checkbox"/> Está seleccionada una opción de texto en el menú de Ajustes (página 31) y no hay texto disponible. Para desactivar esta función, seleccione No en la opción Caption Vision (subtítulos). Si desea ver subtítulos, escoja CC1-4 en lugar de Text1-4.</li> </ul>

Si después de leer este manual de instrucciones, tiene más preguntas relacionadas con el uso del televisor Sony, póngase en contacto con su proveedor Sony más cercano para recibir asistencia técnica.

## Especificaciones

Sistema de televisión	Estándar de televisión estadounidense /NTSC
Cobertura de canales	VHF: 2-13/UHF: 14-69/CATV: 1-125
Antena	Terminal de antena externa para VHF/UHF de 75 ohm
Tubo de imagen	Cinescopio FD Trinitron®
Requisitos de alimentación para todos los países excepto en donde se indique:	ca 120 V 60 Hz ca 220 V 50/60 Hz (Chile, Perú, Bolivia)
Accesorios incluidos	Baterías (R6) de tamaño AA (2) Control remoto RM-Y181 (1) (KV-38FS200), RM-180 (1) (KV-29FS100, KV-34FS100)
Accesorios opcionales	Cables de conexión VMC-810S/820S, VMC-720M, YC-YC-15V/30V, RK74A Mezclador EAC-66 U/V Mesa para televisor: SU-27FS1 (KV-29FS100), SU-32FS1 (KV-34FS100), SU-36FS1 (KV-38FS200)

### KV-29FS100

Tamaño de la pantalla	Tamaño de pantalla visible: 679 mm (27 pulgadas) medido en diagonal Tamaño de pantalla real: 736,6 mm (29 pulgadas) medido en diagonal		
Entradas/salidas	Entradas	1 de video, 1 de audio (panel frontal) 2 de video, 2 de audio (panel posterior) 1 S VIDEO 1 Y, PB,PR, 1 de audio 1 RF	Salidas 1 Salida de Audio
Salida de bocina	10 W × 2		
Consumo de energía para todos los países excepto en donde se indique:	180 W 175 W (Chile, Perú, Bolivia) 1 W en espera		
Dimensiones (Anch. × Alt. × Prof.):	768 x 589 x 497 mm (30 <sup>1</sup> / <sub>4</sub> x 23 <sup>1</sup> / <sub>4</sub> x 19 <sup>5</sup> / <sub>8</sub> pulgadas)		
Peso	49,5 kg (109 lbs. 2 oz.)		

### KV-34FS100

Tamaño de la pantalla	Tamaño de pantalla visible: 803 mm (32 pulgadas) medido en diagonal Tamaño de pantalla real: 863,6 mm (34 pulgadas) medido en diagonal		
Entradas/salidas	Entradas	1 de video, 1 de audio (panel frontal) 2 de video, 2 de audio (panel posterior) 1 S VIDEO 1 Y, PB,PR, 1 de audio 1 RF	Salidas 1 Salida de Audio
Salida de bocina	10 W × 2		
Consumo de energía para todos los países excepto en donde se indique:	190 W 185 W (Chile, Perú, Bolivia) 1 W en espera		
Dimensiones (Anch. × Alt. × Prof.):	898 x 696 x 576 mm (35 <sup>3</sup> / <sub>8</sub> x 27 <sup>3</sup> / <sub>8</sub> x 22 <sup>5</sup> / <sub>8</sub> pulgadas)		
Peso	75 kg (165 lbs. 6 oz.)		

### KV-38FS200

Tamaño de la pantalla	Tamaño de pantalla visible: 911 mm (36 pulgadas) medido en diagonal Tamaño de pantalla real: 965,2 mm (38 pulgadas) medido en diagonal		
Entradas/salidas	Entradas	1 de video, 1 de audio (panel frontal) 2 de video, 2 de audio (panel posterior) 1 S VIDEO 1 Y, PB,PR, 1 de audio 2 RF	Salidas 1 Salida de Audio
Salida de bocina	10 W × 2		
Consumo de energía para todos los países excepto en donde se indique:	195 W 1 W en espera		
Dimensiones (Anch. × Alt. × Prof.):	985 x 774 x 633 mm (38 <sup>3</sup> / <sub>4</sub> x 30 <sup>1</sup> / <sub>2</sub> x 25 pulgadas)		
Peso	98,4 kg (216 lbs. 8 oz.)		

*El diseño y las especificaciones están sujetos a cambios sin previo aviso.*

# Índice alfabético

## A

- Agudos **25**
- Autoprogramación **17, 28**
- Auto SAP **25**
- Auto Volumen **25**

## B

- Balance **25**
- Bloquear o Desbloquear **29**
- Bocinas **26**
- Brillo **24**

## C

- Cable **27**
- Canales Favoritos **27**
- Caption Vision (Subtítulos) **31**
- Características del televisor **1**
- Color **24**
- Conexiones
  - Cable y antena **7**
  - Decodificador y cable **9**
  - Decodificador y televisor **8**
  - Conexión de una cámara de video **15**
  - Conexión de un reproductor de DVD **14**
  - Conexión de un sistema de sonido **15**
  - Conexión de un televisor, una videgrabadora y un decodificador **11**
  - Conexión de un televisor, un receptor de satélite y una videgrabadora **13**
  - Conexión de un televisor y una videgrabadora **10**
  - Conexión de un televisor y un receptor de satélite **12**
- Contraste **24**
- Control remoto
  - Baterías **2**
  - Programación **33**
  - Uso **3, 4**

## D

- Demo(Demostración) **31**
- DISPLAY(Despliegue) **4**

## E

- Efecto
  - No **25**
  - Surround **25**
- Especificaciones **38**
- Etiqueta de Video **31**

## F

- Fijar Canal **27**

## G

- Graves **25**

## H

- Hora actual **30**

## I

- Idioma **31**
- Imagen dentro de una Imagen (PIP) **20**

## M

- Menú Avanzado **32**
- Menús
  - Ajustes **31**
  - Audio **25**
  - Básico **32**
  - Bloqueo de Canal **29**
  - Canal **27**
  - Timer (Reloj) **30**
  - Video **24**
- Modo 16:9 **31**
- Modo
  - Deportes **24**
  - Estándar **24**
  - Película **24**
  - Vívido **24**
- MTS
  - Auto SAP **25**
  - Estéreo **25**
  - Mono **25**

## N

- Nitidez **24**
- Nombre del Canal **28**

## O

- Omitir/Añadir Canal **28**

## P

- Panel frontal del televisor **2**
- Panel posterior del televisor **5**

## R

- Rotación **31**

## S

- Salida de Audio **26**
- SLEEP (Apagado automático) **3**
- Solución de problemas **36**

## T

- Temperatura del Color **24**
- Timer 1 y Timer 2 (Reloj 1 y Reloj 2) **30**
- Tinte **24**

## V

- VM (Modulación de velocidad) **24**

Corporación Sony

Impreso en EE.UU.

# PRINTING THE SERVICE MANUAL

The PDF of this service manual is not designed to be printed from cover to cover. The pages vary in size, and must therefore be printed in sections based on page dimensions.

## NON-SCHEMATIC PAGES

Data that does NOT INCLUDE schematic diagrams are formatted to 8.5 x 11 inches and can be printed on standard letter-size and/or A4-sized paper.

## SCHEMATIC DIAGRAMS

The schematic diagram pages are provided in two ways, full size and tiled. The full-sized schematic diagrams are formatted on paper sizes between 8.5" x 11" and 18" x 30" depending upon each individual diagram size. Those diagrams that are LARGER than 11" x 17" in full-size mode have been tiled for your convenience and can be printed on standard 11" x 17" (tabloid-size) paper, and reassembled.

### TO PRINT FULL SIZE SCHEMATIC DIAGRAMS

---

If you have access to a large paper plotter or printer capable of outputting the full-sized diagrams, output as follows:

- 1) Note the page size(s) of the schematics you want to output as indicated in the middle window at the bottom of the viewing screen.
- 2) Go to the File menu and select Print Set-up. Choose the printer name and driver for your large format printer. Confirm that the printer settings are set to output the indicated page size or larger.
- 3) Close the Print Set Up screen and return to the File menu. Select "Print..." Input the page number of the schematic(s) you want to print in the print range window. Choose OK.

### TO PRINT TILED VERSION OF SCHEMATICS

---

Schematic pages that are larger than 11" x 17" full-size are provided in a 11" x 17" printable tiled format near the end of the document. These can be printed to tabloid-sized paper and assembled to full-size for easy viewing.



If you have access to a printer capable of outputting the tabloid size (11" x 17") paper, then output the tiled version of the diagram as follows:

- 1) Note the page number(s) of the schematics you want to output as indicated in the middle window at the bottom of the viewing screen.
- 2) Go to the File menu and select Print Set-up. Choose the printer name and driver for your printer. Confirm that the plotter settings are set to output 11" x 17", or tabloid size paper in landscape (  ) mode.
- 3) Close the Print Set Up screen and return to the File menu. Select "Print..." Input the page number of the schematic(s) you want to print in the print range window. Choose OK.

### TO PRINT SPECIFIC SECTIONS OF A SCHEMATIC

---

To print just a particular section of a PDF, rather than a full page, access the Graphics Select tool in the Acrobat Reader tool bar.

- 1) To view the Graphics Select Tool, press and HOLD the mouse button over the Text Select Tool which looks like: . This tool will expand to reveal to additional tools. Choose the Graphics Select tool by placing the cursor over the button on of the far right that looks like: 
- 2) After selecting the Graphics Select Tool, place your cursor in the document window and the cursor will change to a plus (+) symbol. Click and drag the cursor over the area you want to print. When you release the mouse button, a marquee (or dotted lined box) will be displayed outlining the area you selected.
- 3) With the marquee in place, go to the file menu and select the "Print..." option. When the print window appears, choose the option under the section called "Print Range" which says "Selected Graphic".

Select OK and the output will print only the area that you outlined with the marquee. 

(continued >)



## ON-SCREEN SEARCH OPTION

All of the text within the service manual PDF is content searchable. This means that you can enter any text, word, phrase or reference number that appears in the manual, and the PDF software will search, find and move the cursor to the location where you requested text first appears. This feature can be particularly useful in locating components on a specific schematic or printed wire circuit board (PWB) diagrams.

Follow these steps to effectively locate a component on a schematic diagram:

- 1) Locate the schematic you want to search by clicking on the corresponding bookmark on the left side of the screen. The view on the right of the screen will then jump to the desired schematic page.
- 2) Magnify the diagram to at least 400% before conducting a component search. This will enable you to easily view the reference number when it is highlighted on screen. To do this, click on the magnifying glass button on the tool bar at the top of the screen. Move the cursor over the diagram and RIGHT click you mouse. Select the 400% magnification option on the pop-up menu. Click on the button with the icon of the open hand to deactivate the magnification tool
- 3) Search the diagram (or the entire manual) by clicking on the binocular button tool at the top of the screen. The "Find" window will appear and allow you to type in your desired text. Type in a reference designator, such as R502, and click on the "Find" button. If the component is not on the diagram, but is listed anywhere else in the manual, the cursor will jump to the first location the text is found in the file. To find another instance of that same text, click on the binocular button again and select "Find Again."

# SERVICE MANUAL

# BA-5D CHASSIS

<u>MODEL NAME</u>	<u>REMOTE COMMANDER</u>	<u>DESTINATION</u>	<u>CHASSIS NO.</u>
<b>KV-27FS100</b>	RM-Y180	US	SCC-S65D-A
<b>KV-27FS100</b>	RM-Y180	CND	SCC-S64D-A
<b>KV-27FS200</b>	RM-Y181	US	SCC-S65E-A
<b>KV-29FS100</b>	RM-Y180	LATIN NORTH	SCC-S62H-A
<b>KV-29FS100</b>	RM-Y180	LATIN SOUTH	SCC-S62J-A
<b>KV-32FS100</b>	RM-Y180	US	SCC-S65F-A
<b>KV-32FS100</b>	RM-Y180	CND	SCC-S64E-A
<b>KV-32FS200</b>	RM-Y181	US	SCC-S65G-A
<b>KV-34FS100</b>	RM-Y180	LATIN NORTH	SCC-S62K-A

## CORRECTION - 1

SUBJECT: REPLACED GK BOARD IC VOLTAGE LIST (IC600)  
REPLACED GK BOARD TRANSISTOR VOLTAGE LIST (Q600, Q601)

Correct the service manual as shown.  
File this Correction with the service manual.

 : Corrected Items

### SECTION 5: DIAGRAMS

#### 5-3. BLOCK DIAGRAM AND SCHEMATICS

GK Board IC Voltage List (Page 46)

GK Board Transistor Voltage List (Page 46)

TRINITRON® COLOR TELEVISION

**SONY**®

## SECTION 5: DIAGRAMS

## 5-3. BLOCK DIAGRAM AND SCHEMATICS (Page 46)

**GK BOARD IC VOLTAGE LIST**

<b>IC600</b>		11	0.0	3	2.4	G	GND	10	4.0	3	4.6
<b>PIN</b>	<b>VOLT</b>	12	4.9	4	8.4	<b>IC1405</b>		11	3.9	4	GND
1	2.8	13	NC	5	GND	<b>PIN</b>	<b>VOLT</b>	12	GND	5	4.6
2	1.9	14	163.9	<b>IC605</b>		1	10.1	13	0.4	6	4.6
3	2.3	15	153.8	<b>PIN</b>	<b>VOLT</b>	2	GND	14	9.9	7	4.6
4	2.6	16	158.2	I	6.1	3	14.0	15	14.0	8	9.0
5	GND	17	NC	O	5.0	4	10.1	16	GND	All voltages are in V.	
6	0.0	18	340.0	G	GND	5	2.9	17	9.9		
7	4.6	<b>IC601</b>		<b>IC609</b>		6	N/C	<b>IC1406</b>			
8	17.5	<b>PIN</b>	<b>VOLT</b>	<b>PIN</b>	<b>VOLT</b>	7	4.0	<b>PIN</b>	<b>VOLT</b>		
9	0.0	1	134.6	I	10.5	8	4.0	1	4.6		
10	10.6	2	N/C	O	9.0	9	11.0	2	4.6		

**GK BOARD TRANSISTOR TABLE**

	<b>B</b>	<b>C</b>	<b>E</b>
<b>Q509</b>	0.3	10.5	GND
<b>Q605</b>	7.6	18.8	7.6
<b>Q606</b>	0.0	0.5	GND
<b>Q608</b>	0.6	0.0	GND
<b>Q690</b>	6.1	0.5	5.9
<b>Q691</b>	6.9	7.6	7.6
<b>Q1401</b>	0.0	GND	0.6

	<b>D</b>	<b>G</b>	<b>S</b>
<b>Q600</b>	340.0	160.0	156.0
<b>Q601</b>	155.0	4.9	0.0

All voltages are in V.